

ROOM FINISH SCHEDULE					
ROOM NAME	FLOOR	WALLS	CEILING	C.G. HGT.	REMARKS
MAIN ROOM	EXPOSED CONC.	1/2" DRY WALL ABOVE 4'-0" TO 8'-0" HIGH 1/2" PLYWOOD MASONRY UP TO 4'-0" HIGH CONCRETE MORTURE PROOF DOOR WALL UP TO 4'-0" HIGH	1/2" DRY WALL 9/8" DRY WALL MARBLE	8'-0"	VARIABLE
TOILET ROOM					SEE DETAIL (1)

PAINT SCHEDULE	
INTERIOR PAINT SCHEDULE	EXTERIOR PAINT SCHEDULE
MAIN ROOM WALLS - FLAT PAINT W/MASONRY BASE (COLOR LIGHT GREEN) CEILING - 1 COAT MILK WHITE TO COVER	MASONRY PAINT AS REQ'D BY SINGLE PAINT CO. (COLOR SFF SPICE)

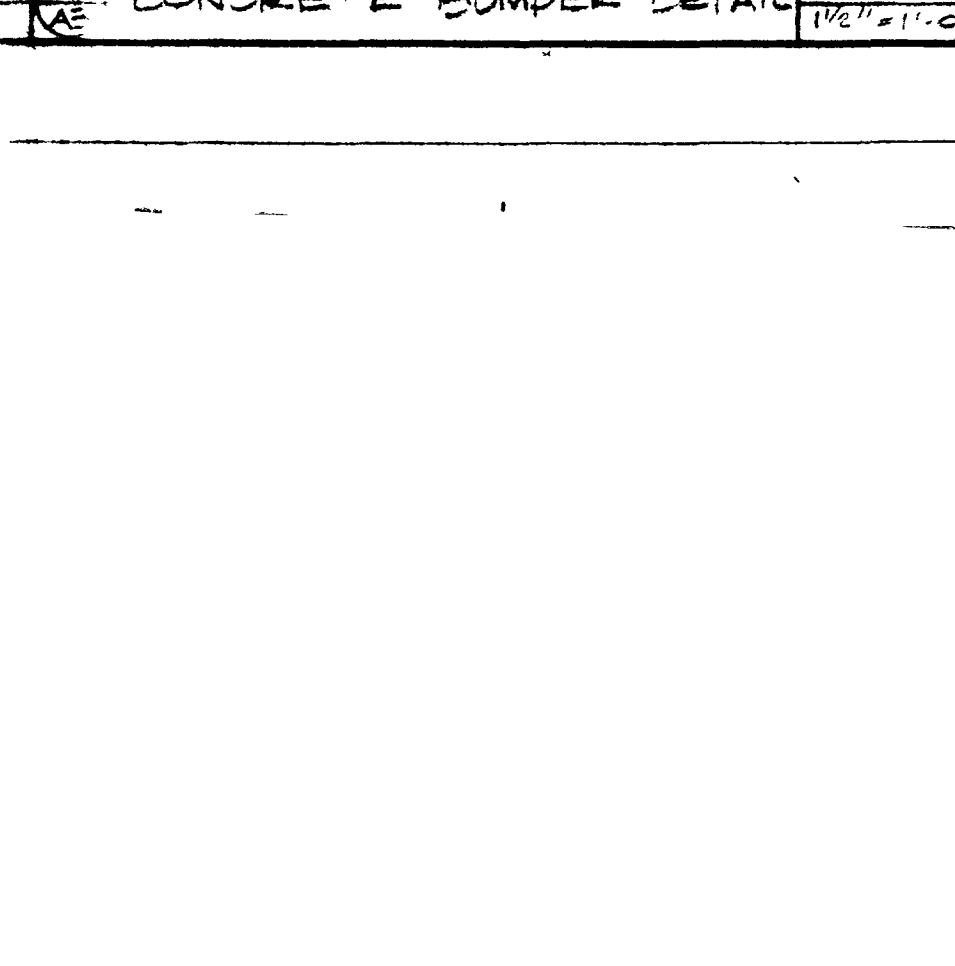

WHOLESALE RETAIL DISTRIBUTION CENTER  
**SMART AND FINAL IES CO.**  
 NORTH MAIN ST. LAS VEGAS, NEVADA  
 JACK H. MACDONALD ARCHITECTS AND ENGINEERS  
 321 S. SAN VICENTE BLVD. LOS ANGELES 90048 272-3131  
 SHEET NO. **1-3**  
 521-228

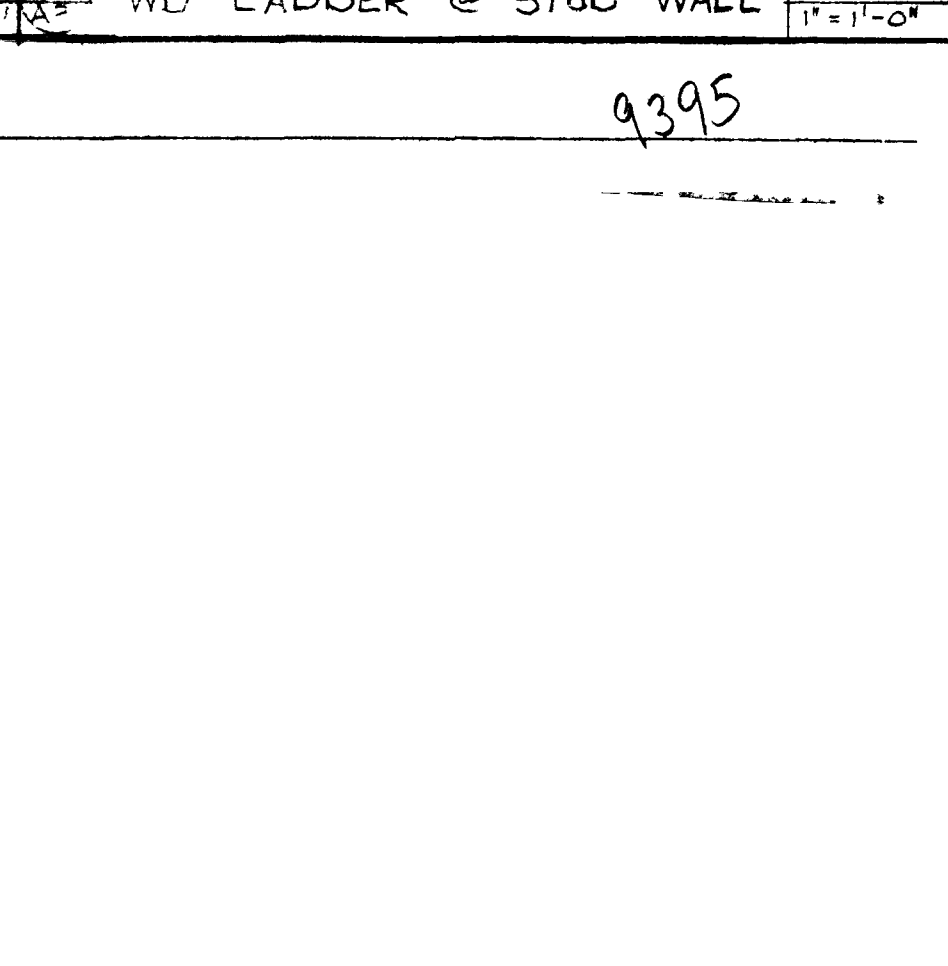
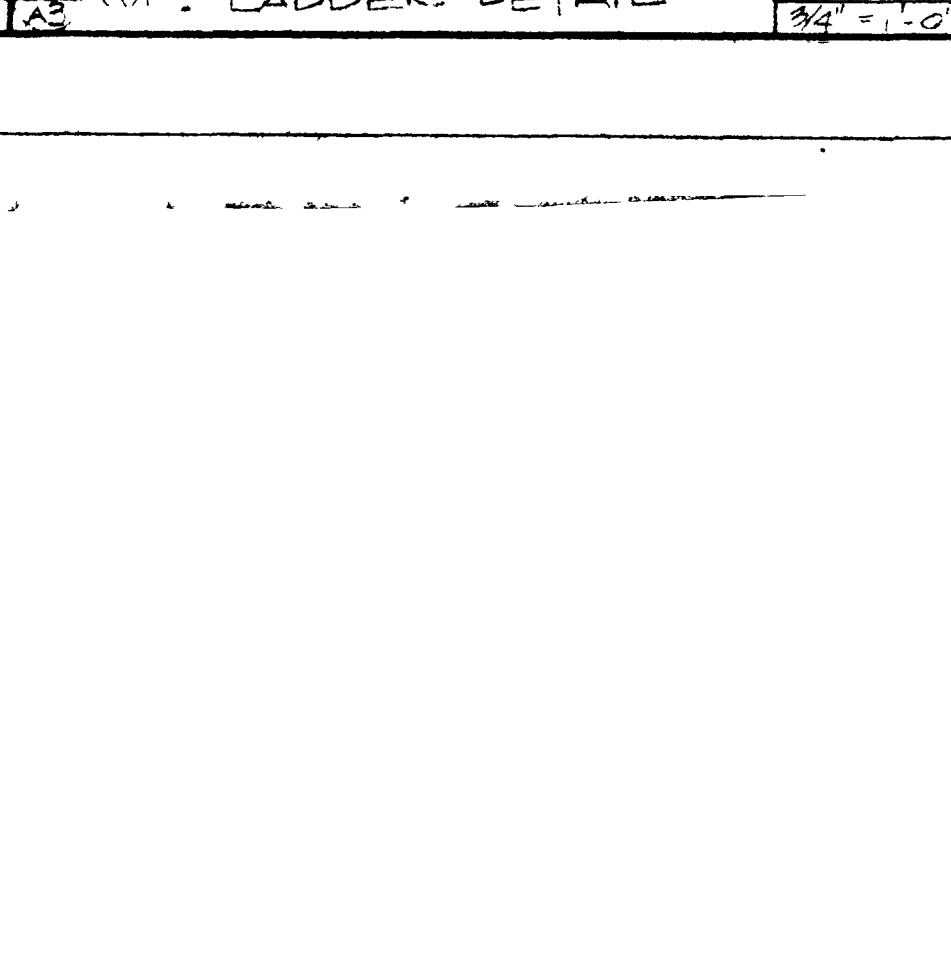
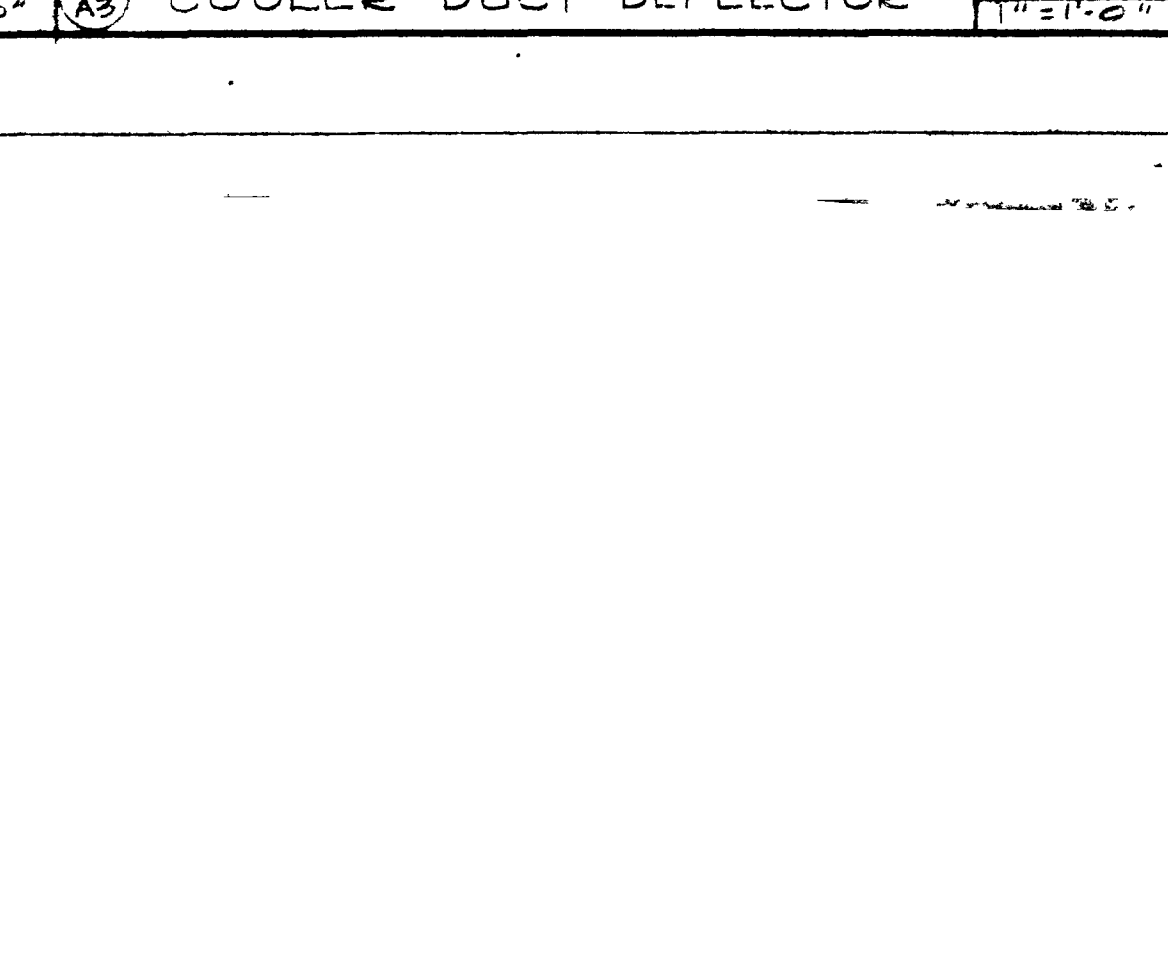
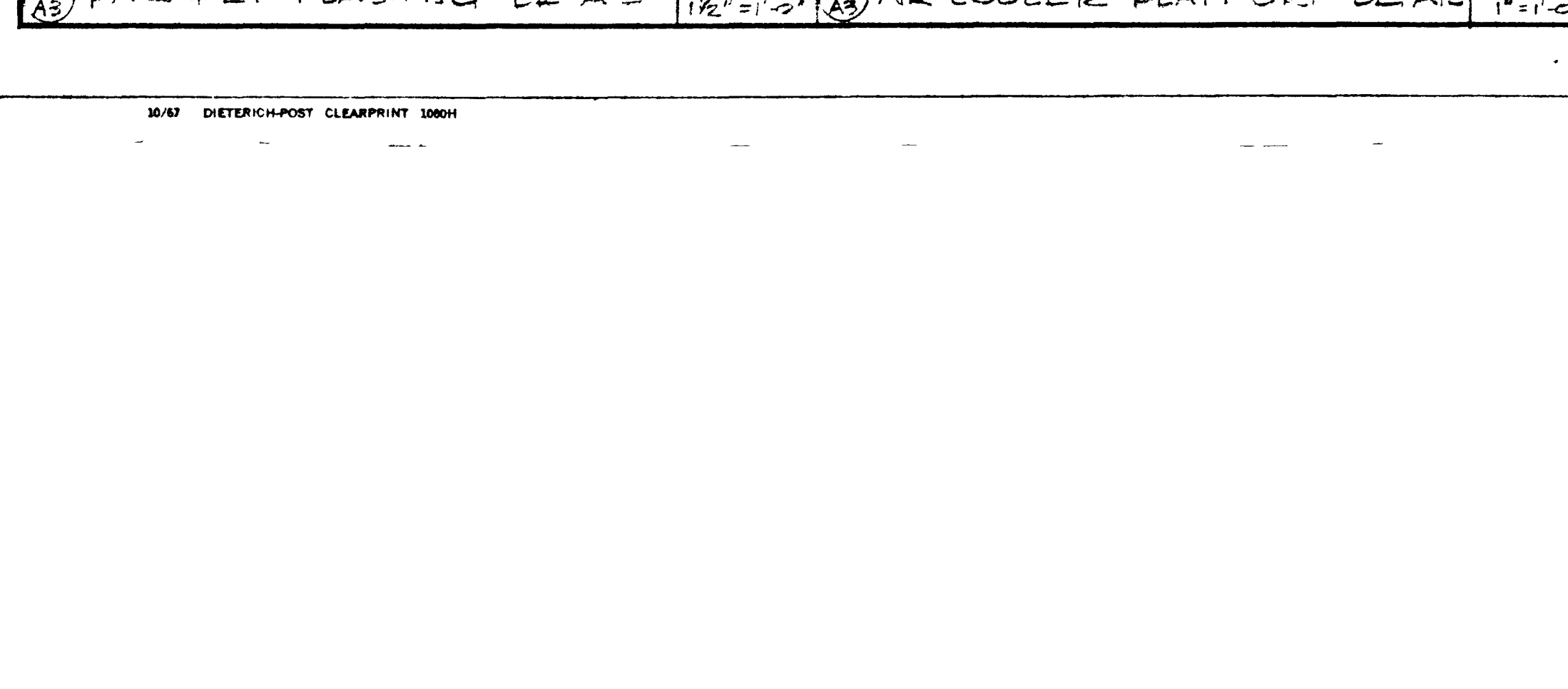
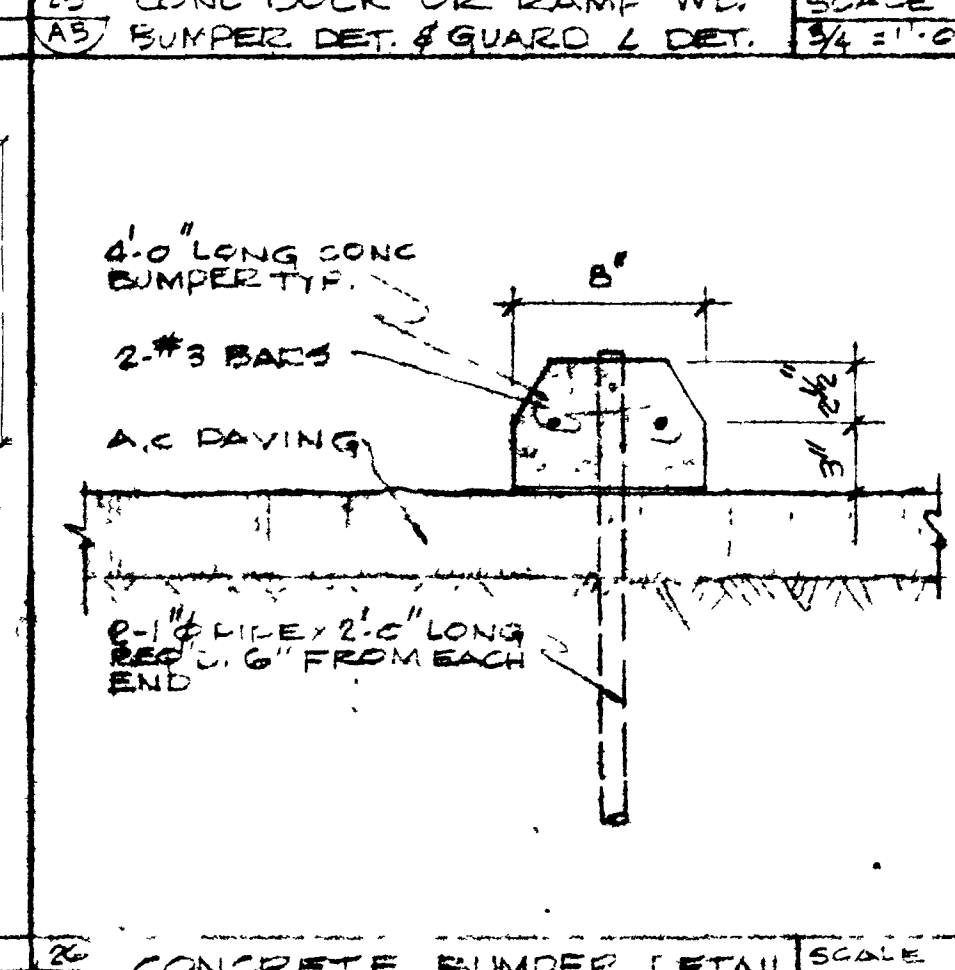
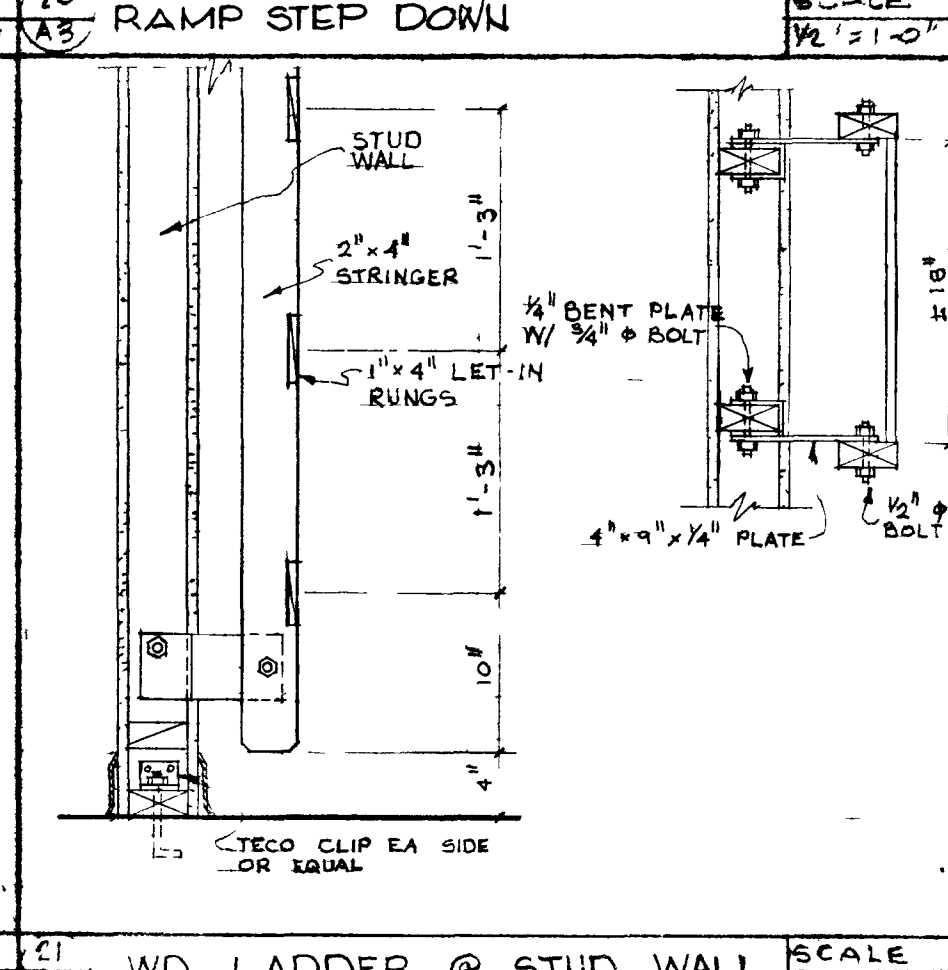
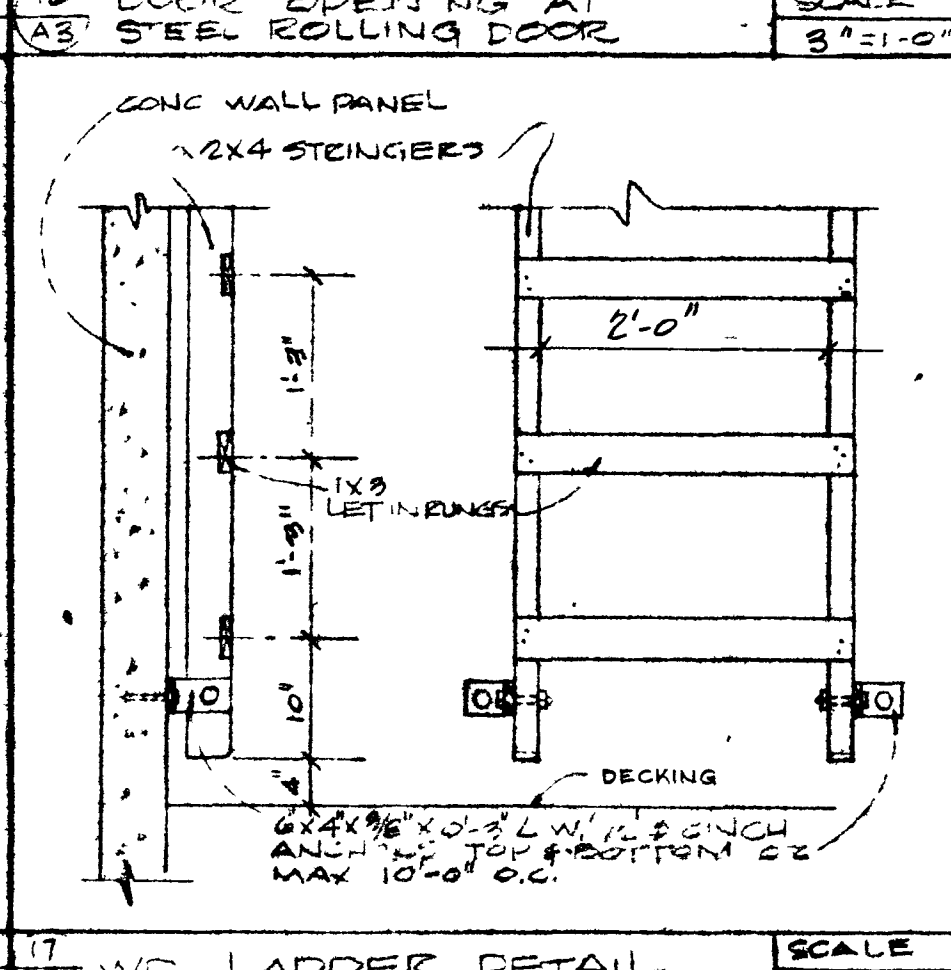
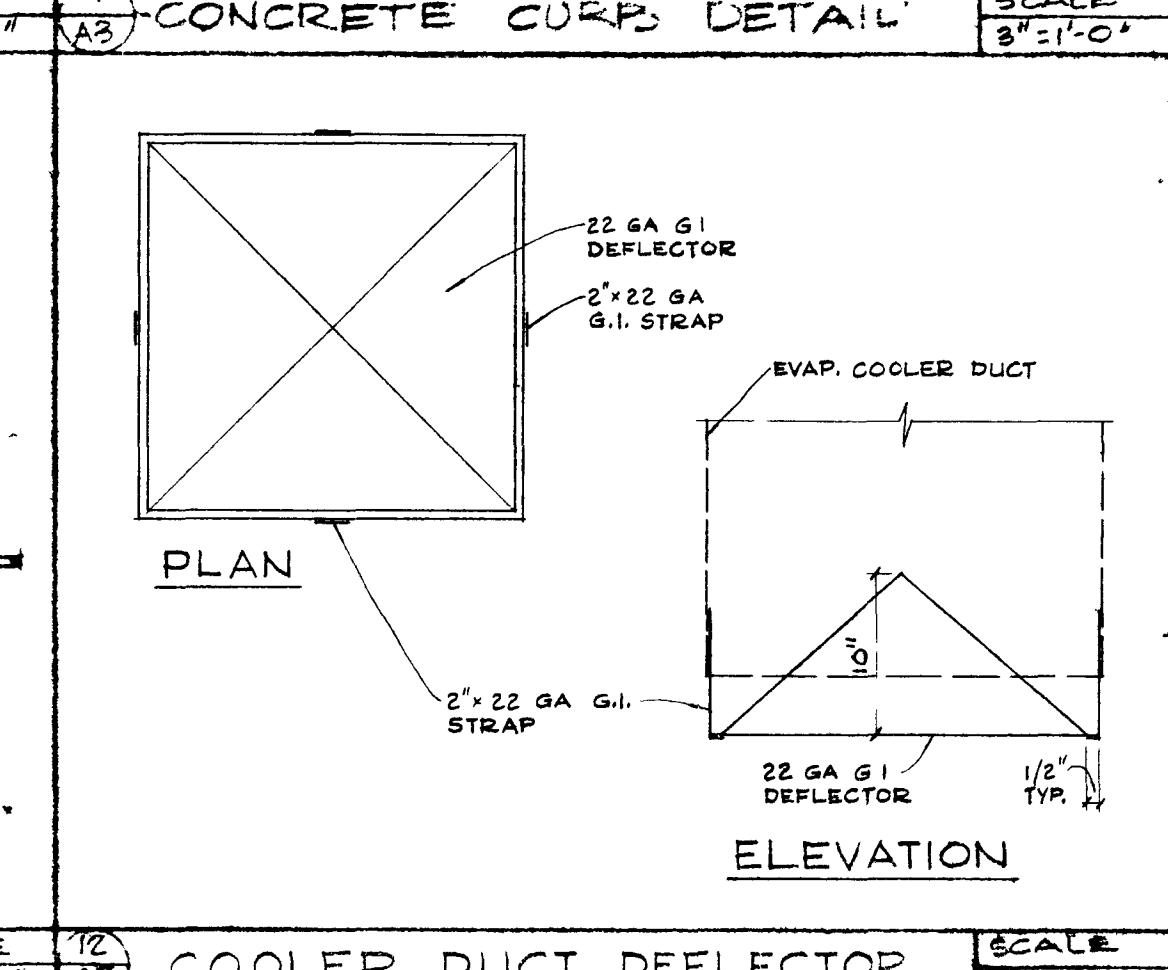
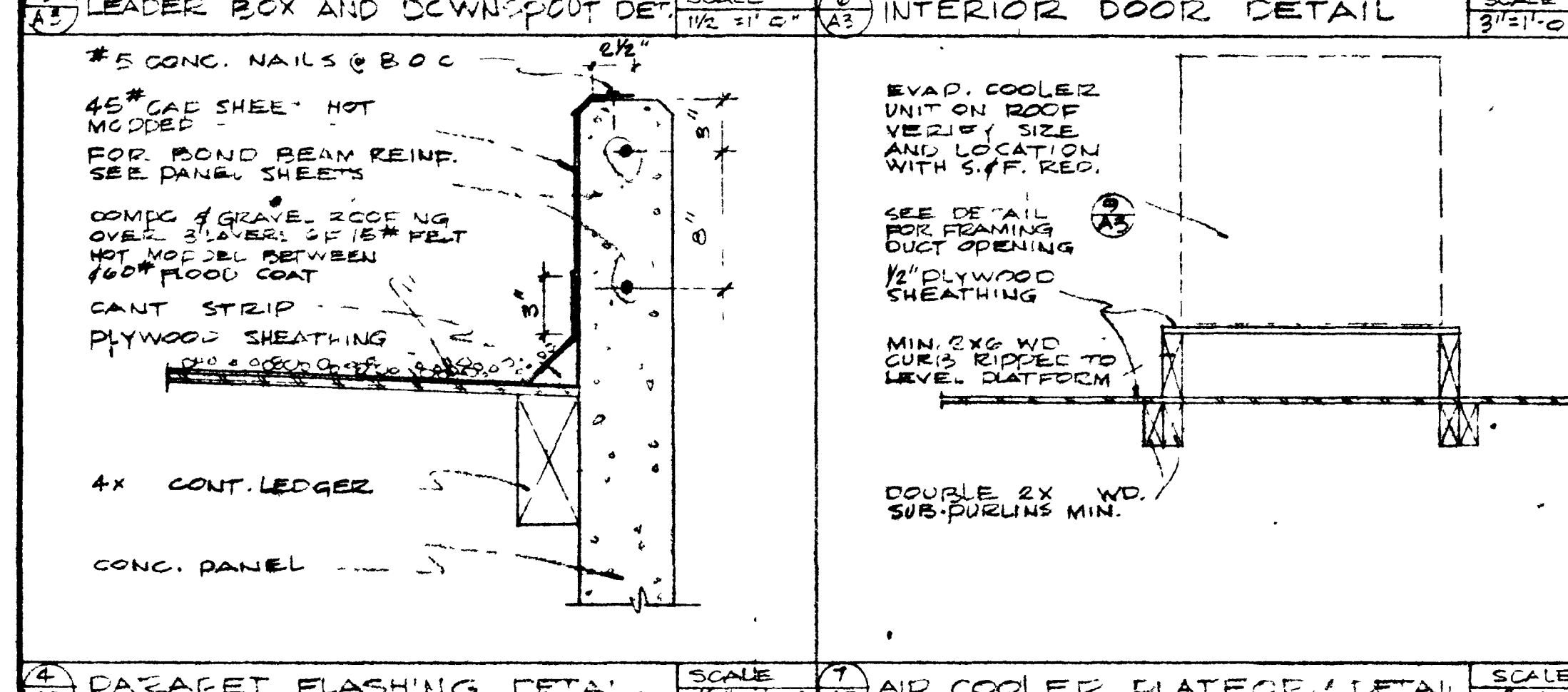
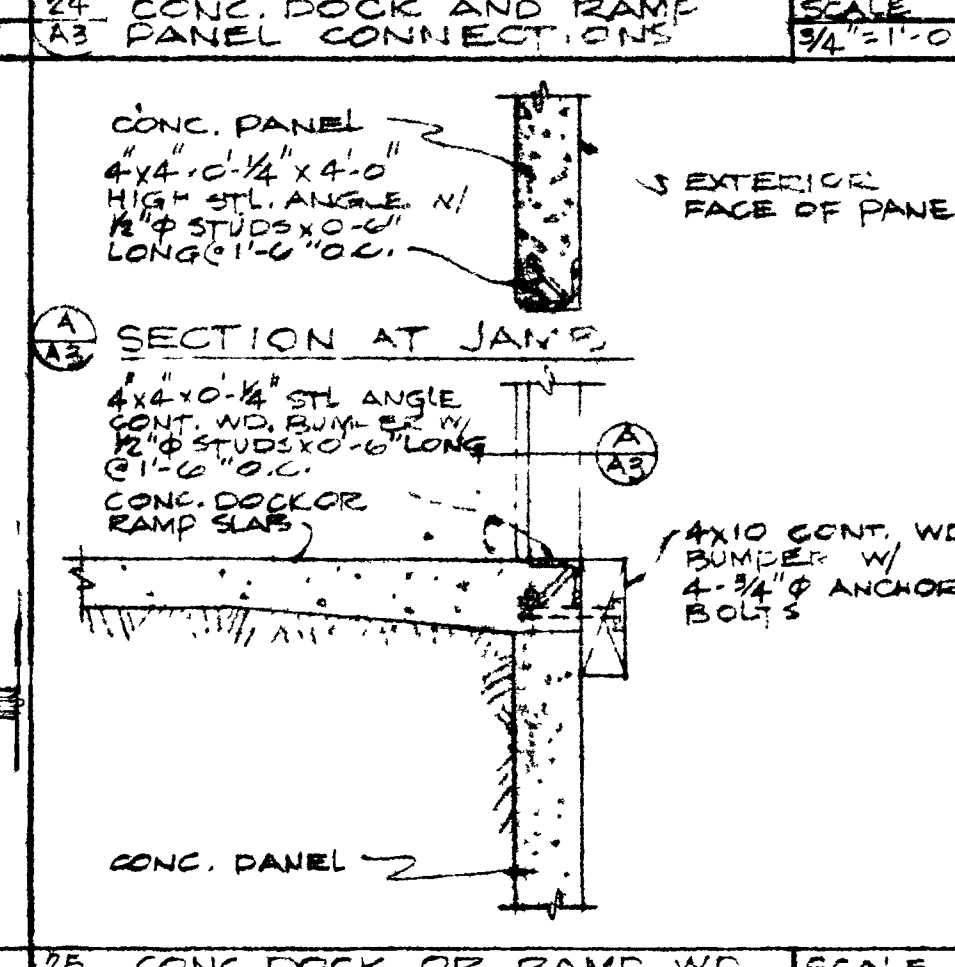
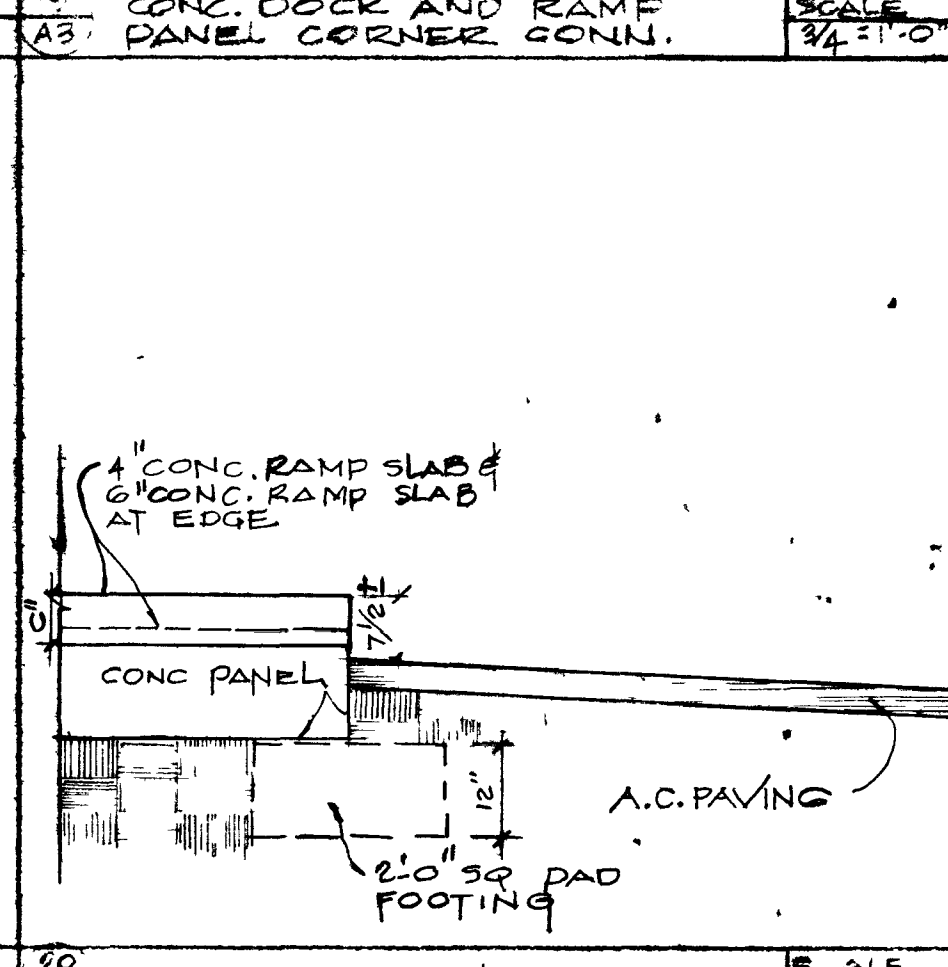
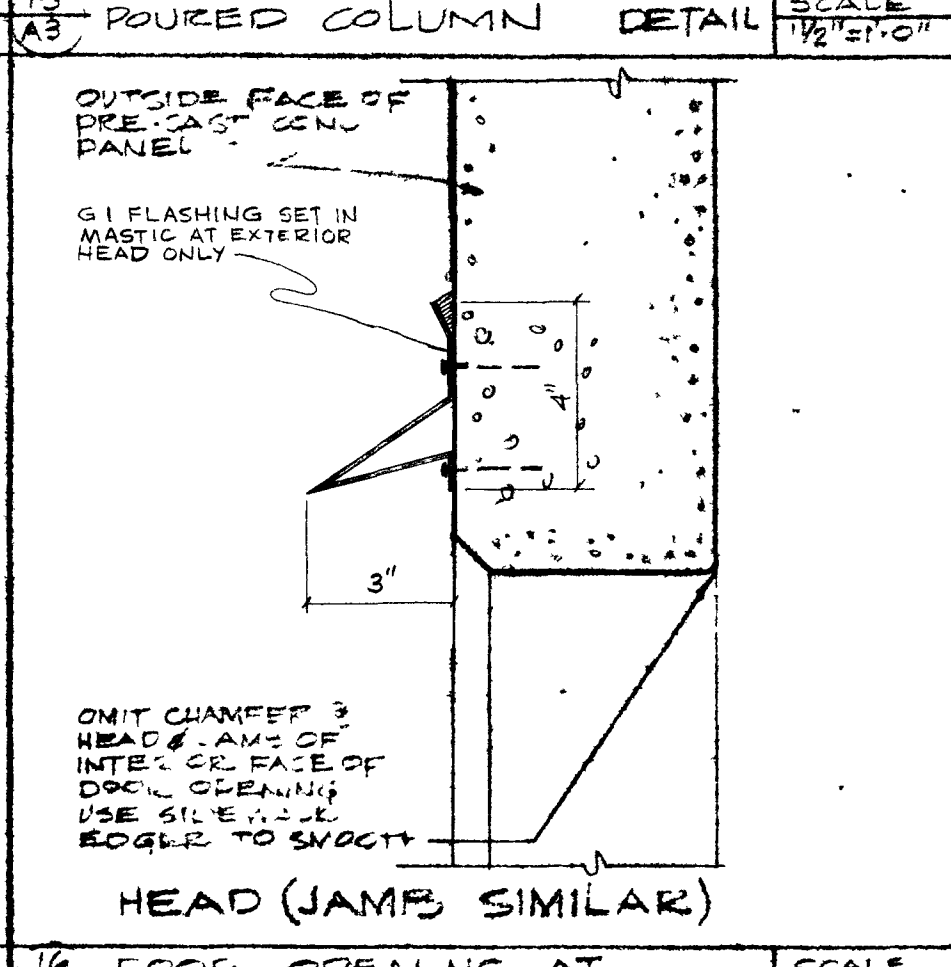
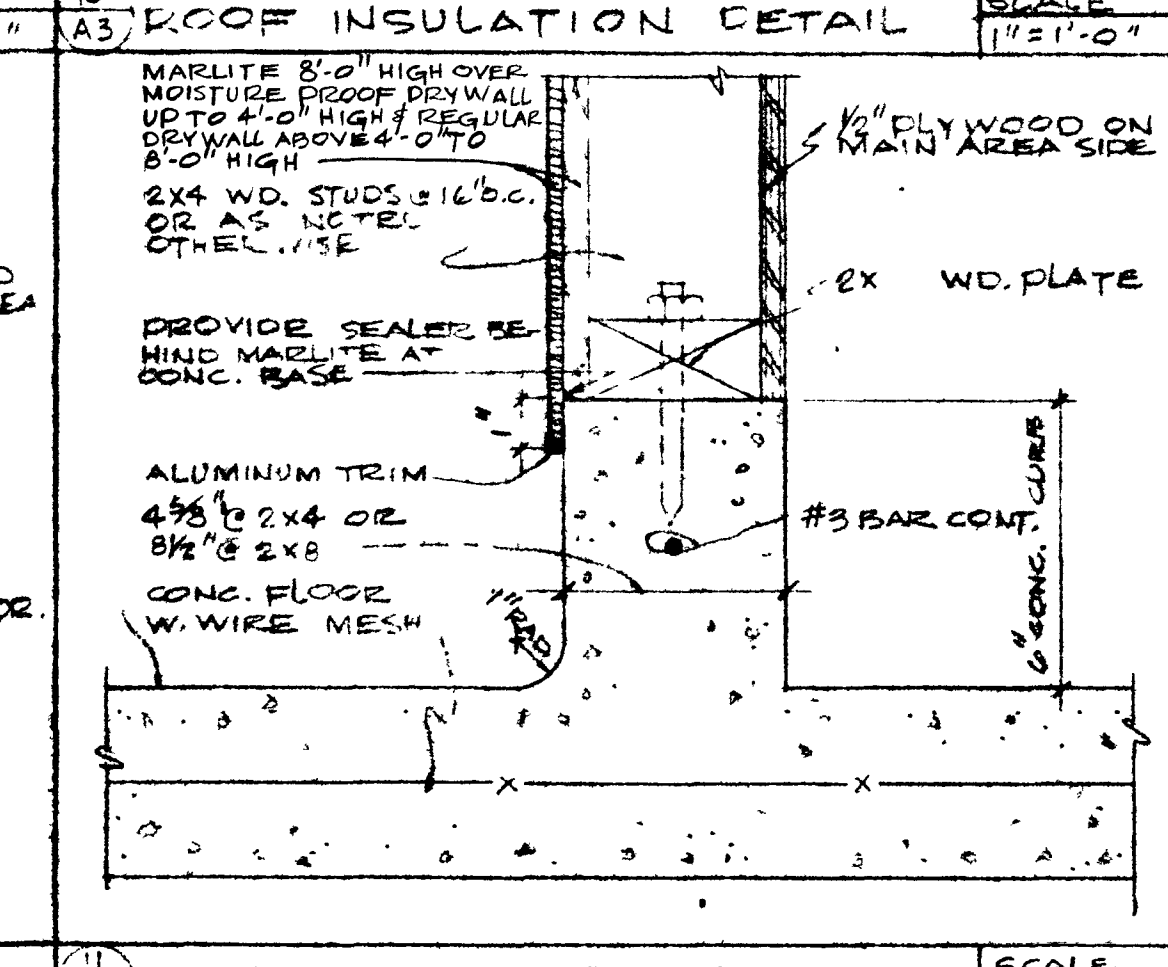
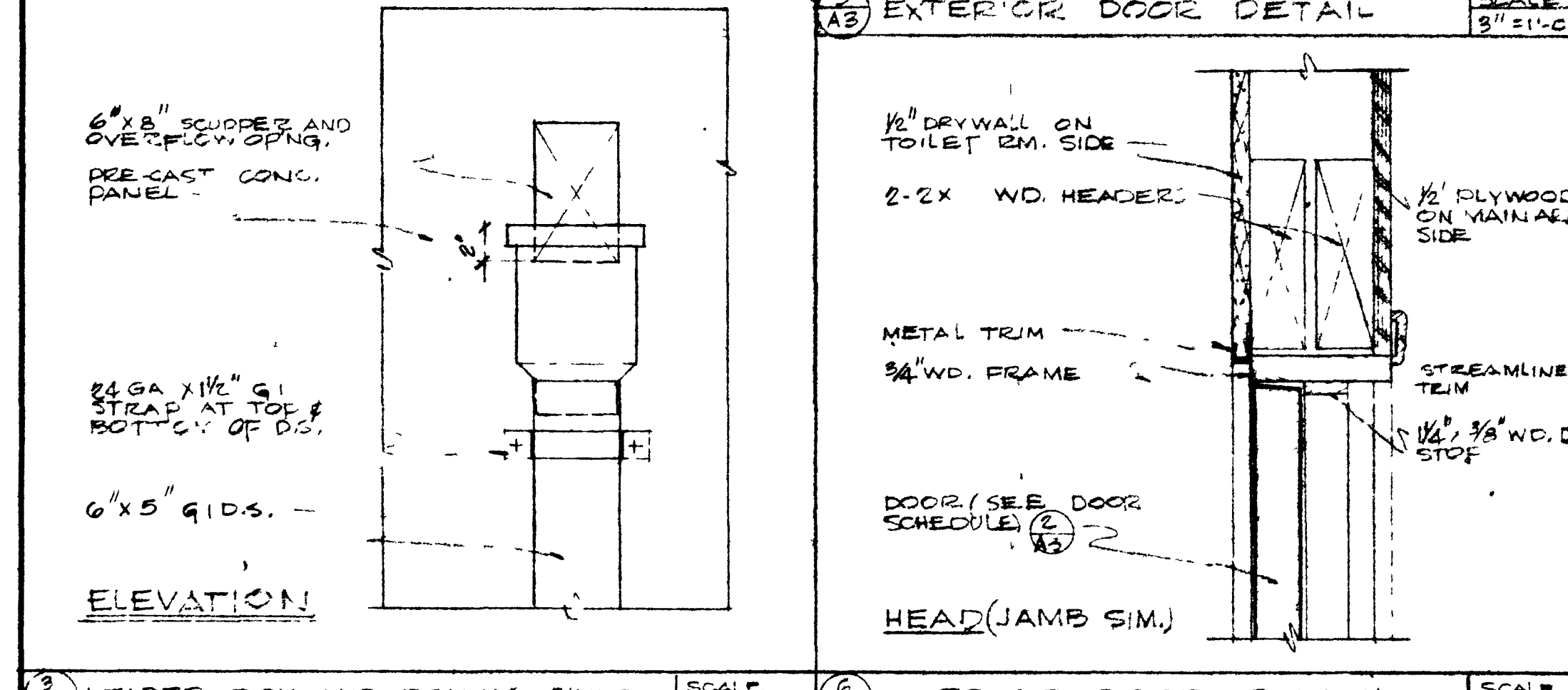
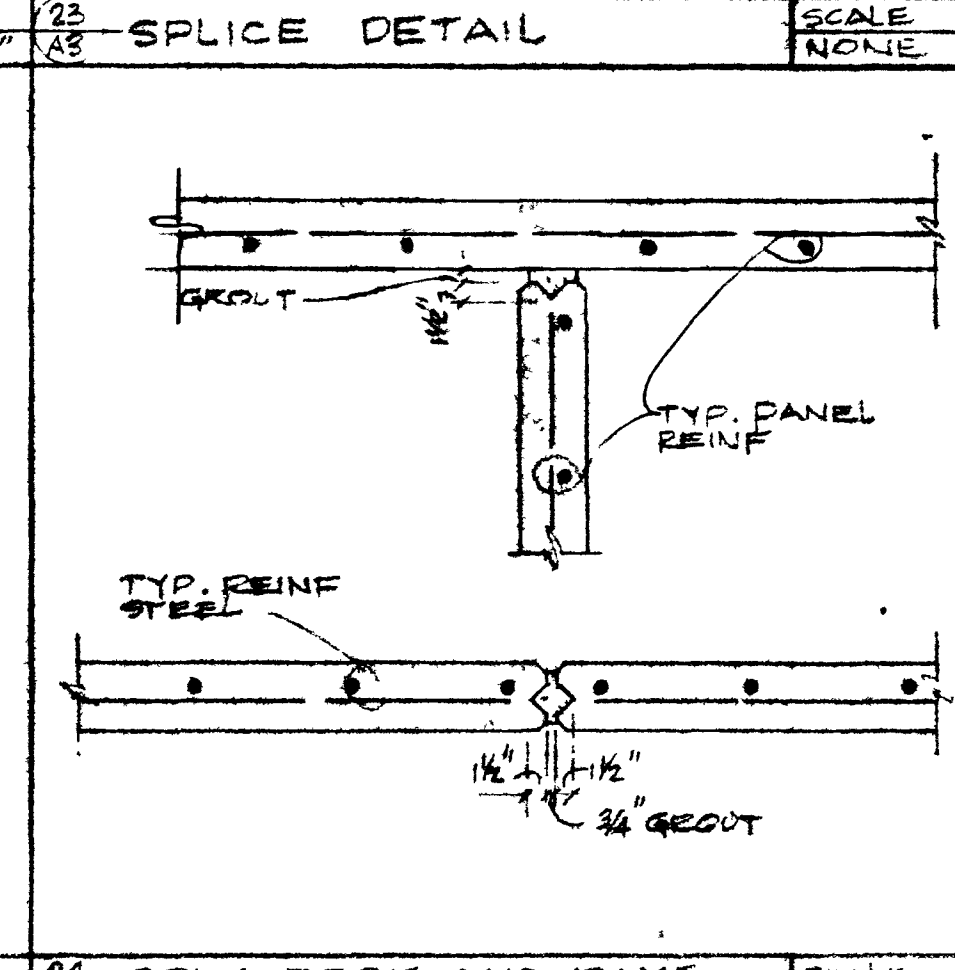
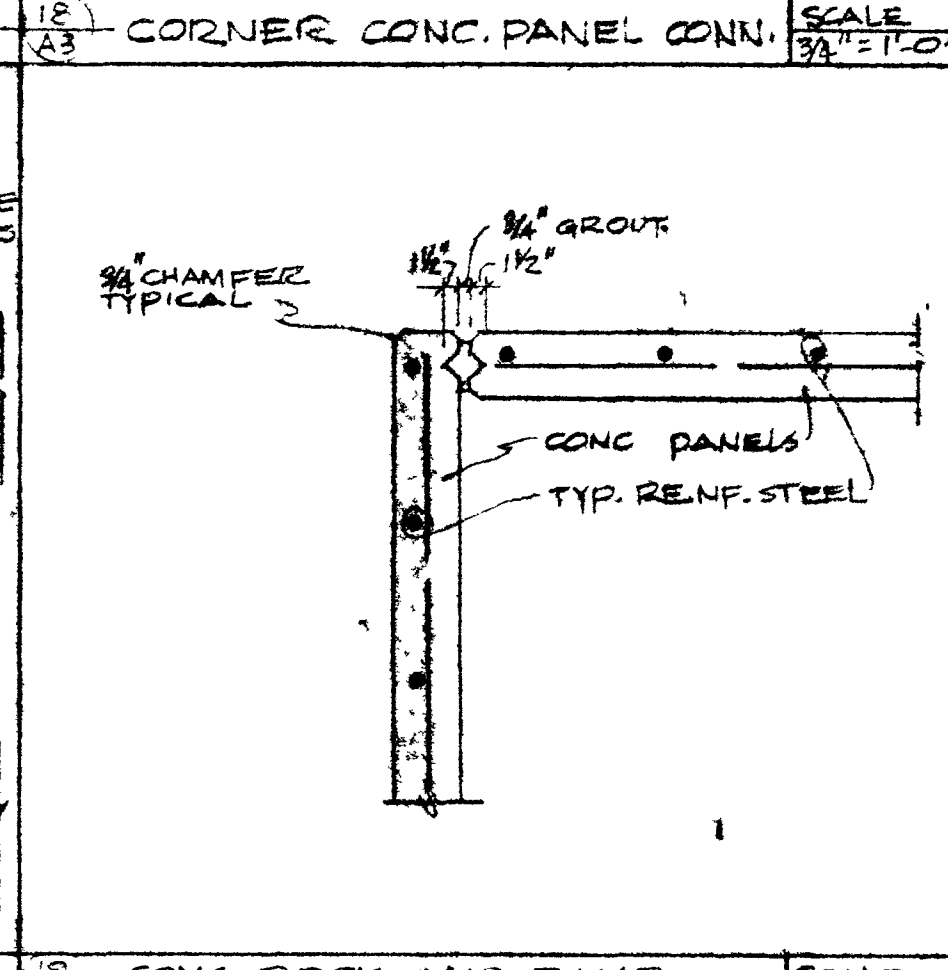
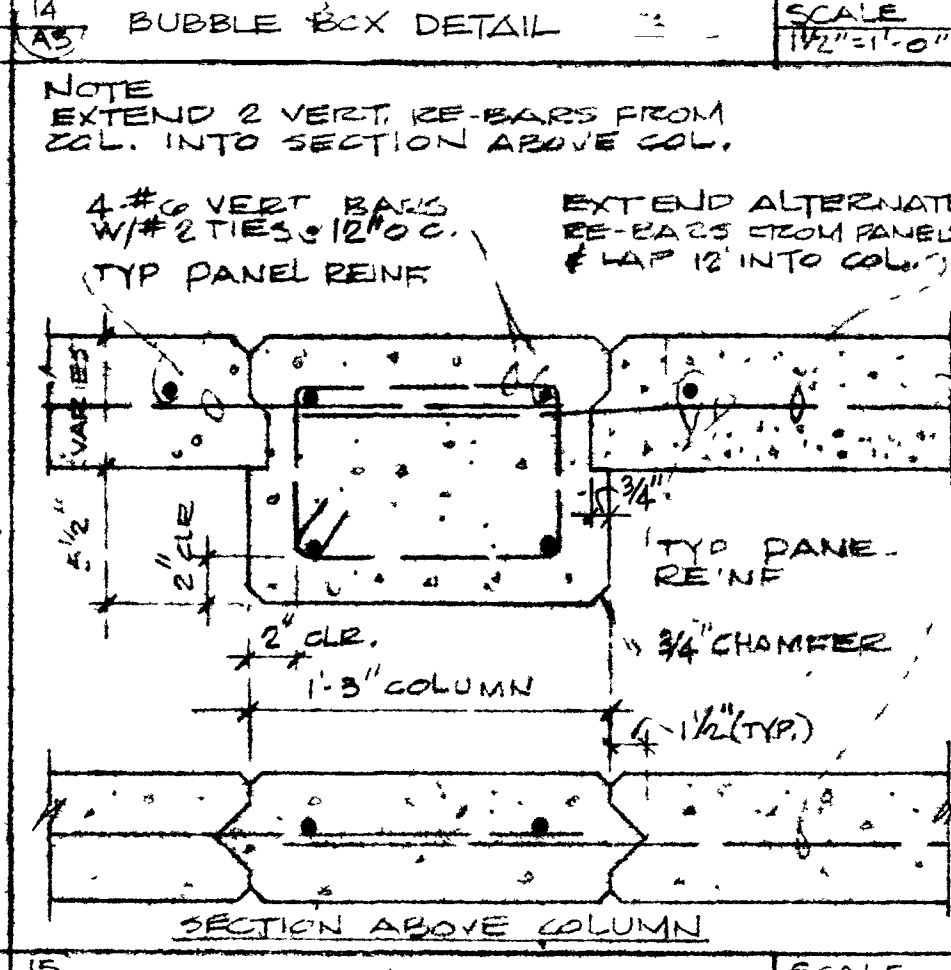
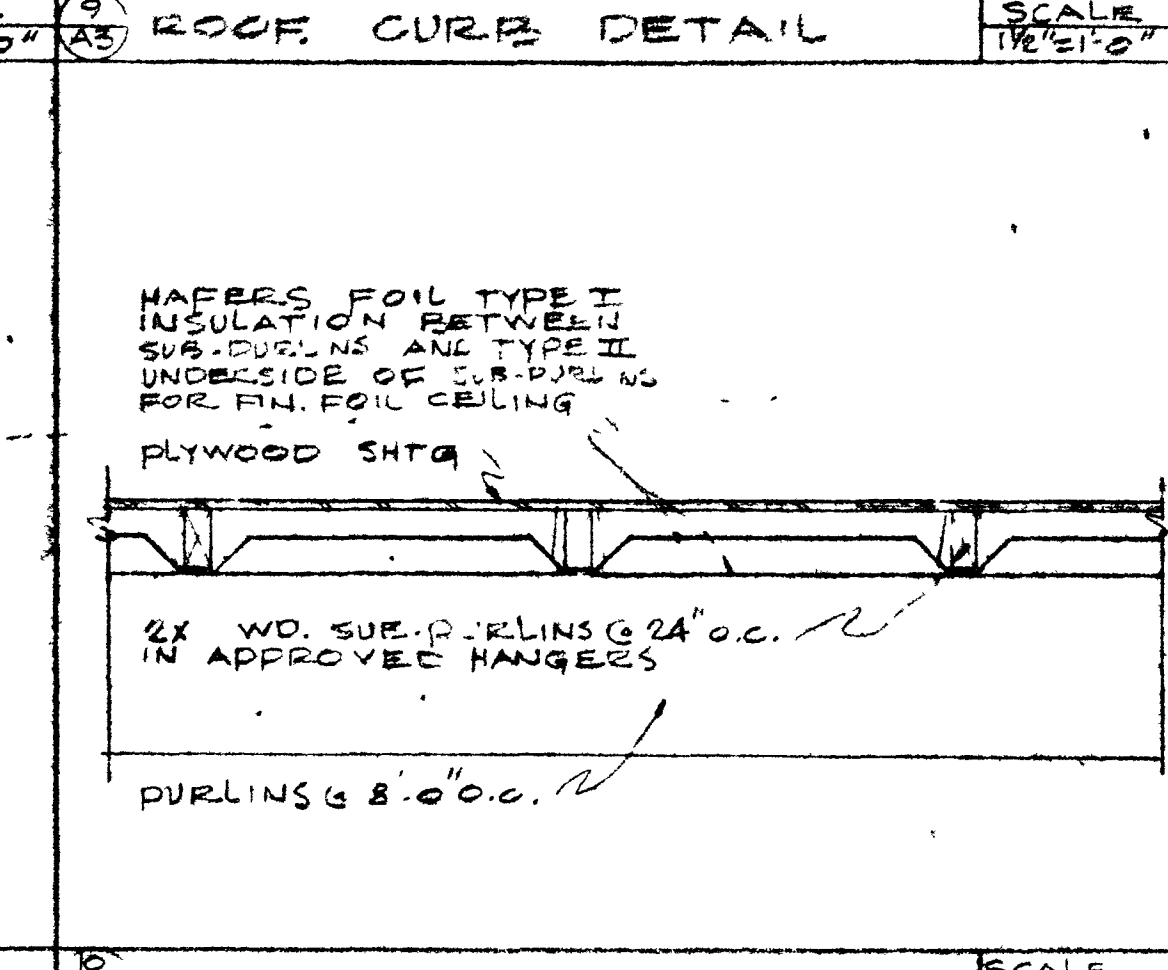
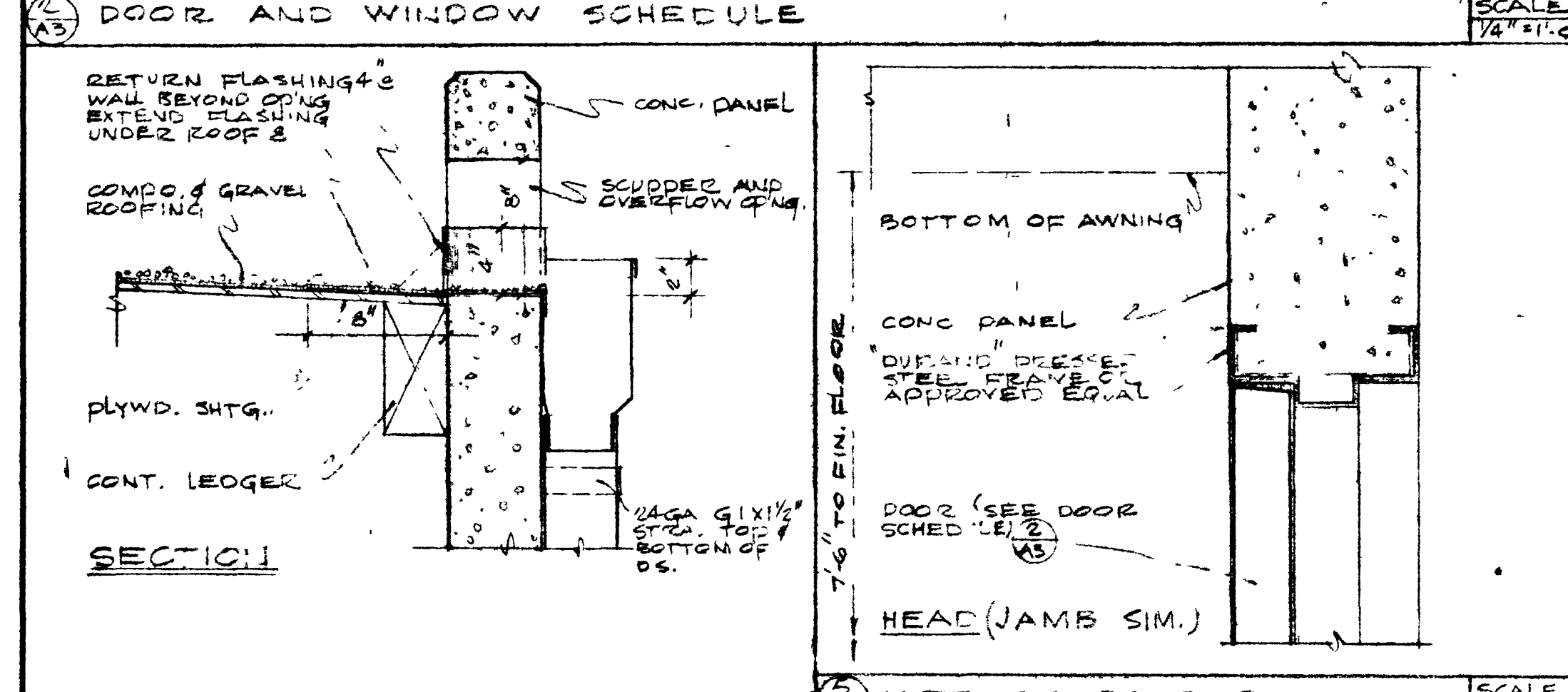
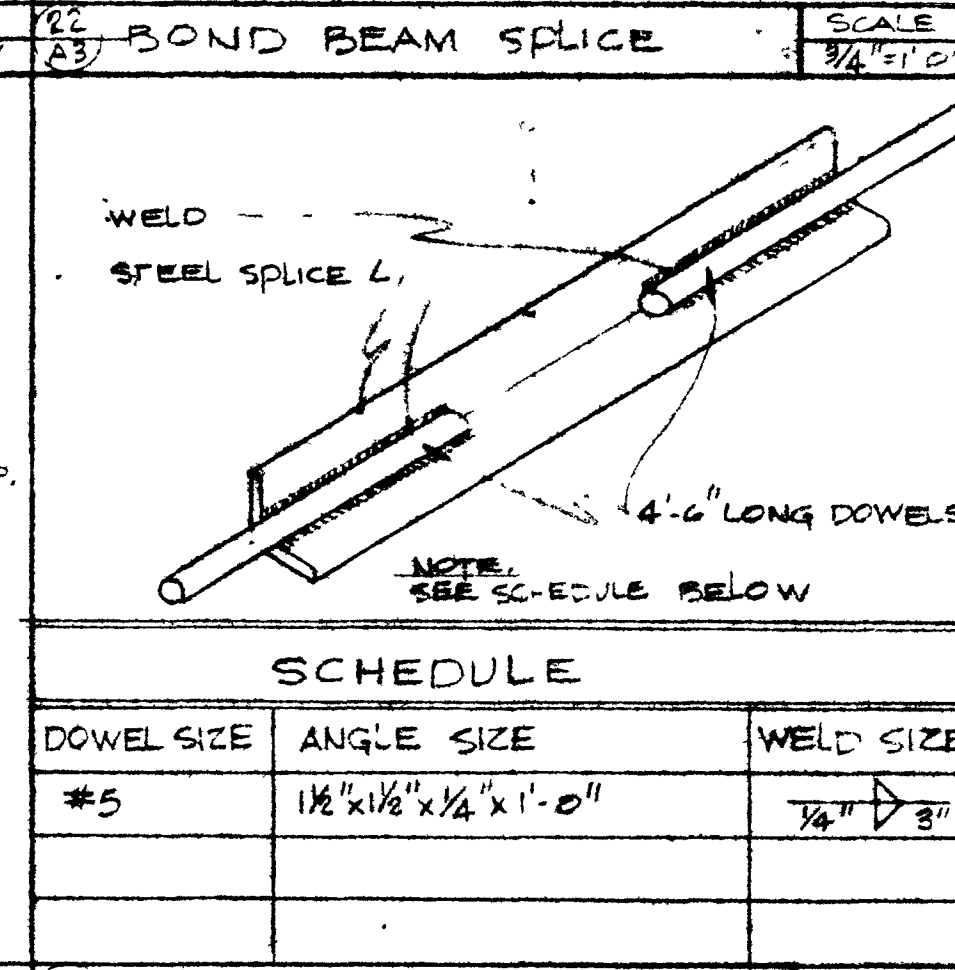
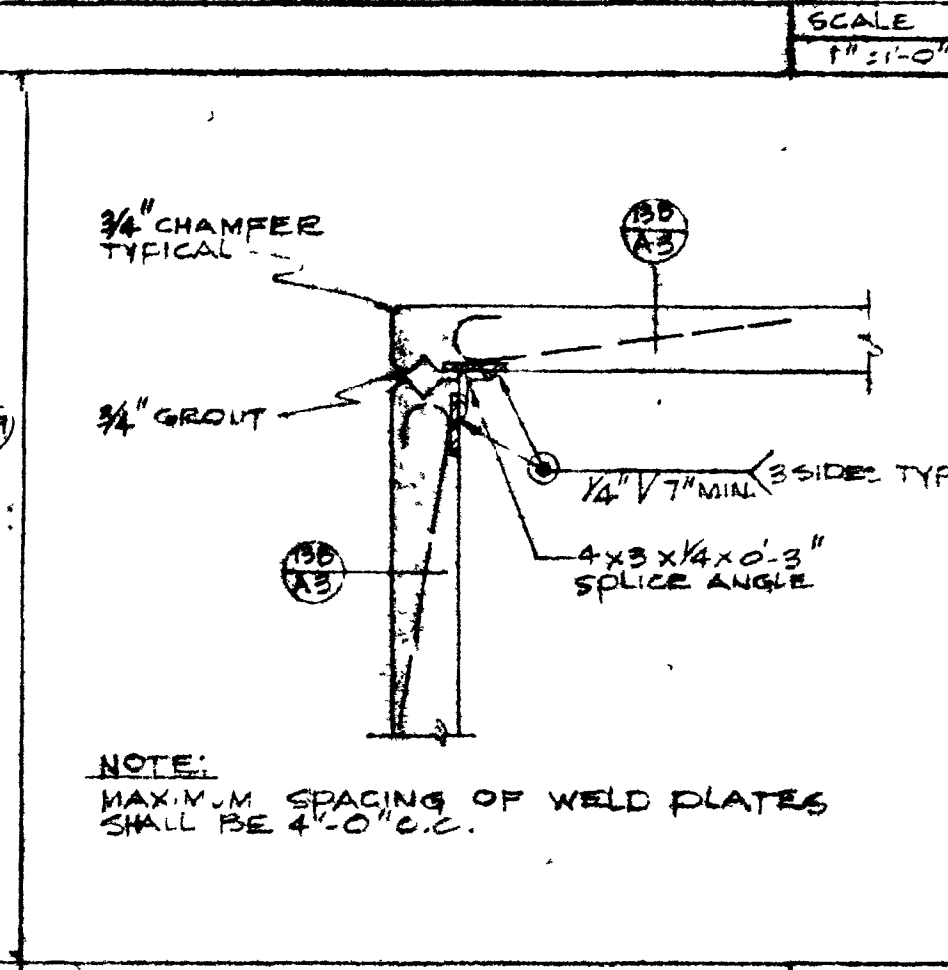
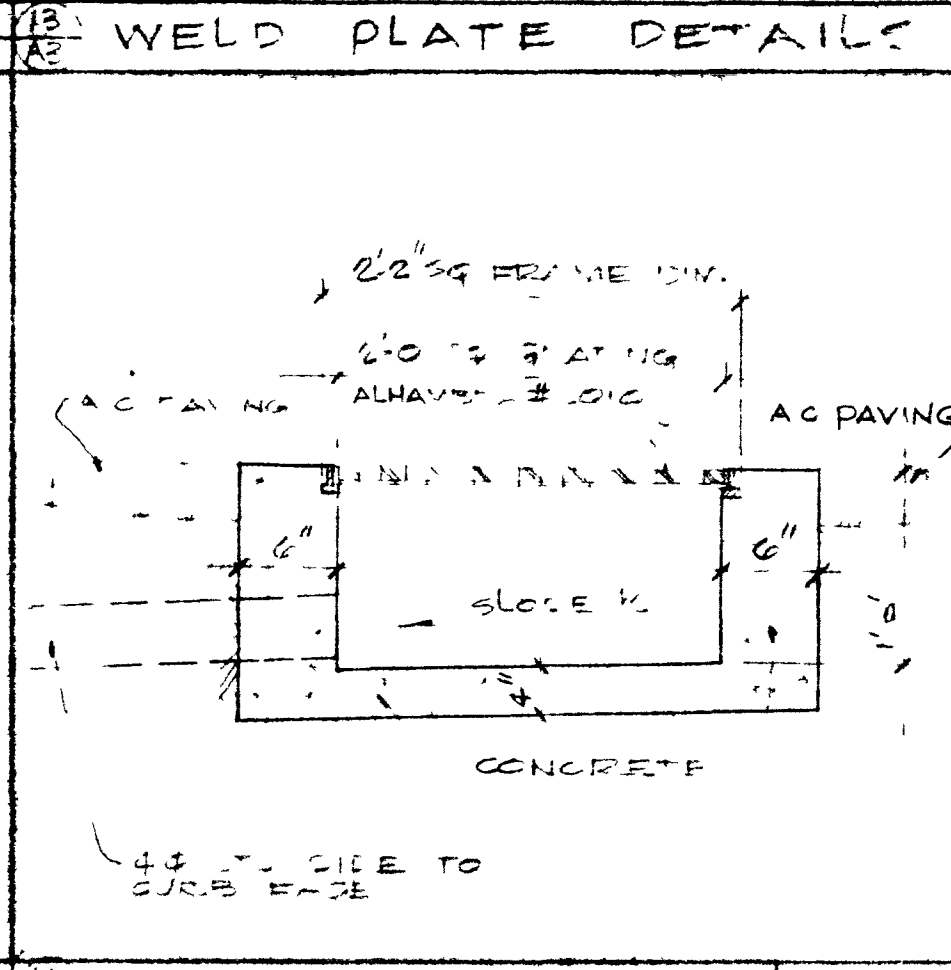
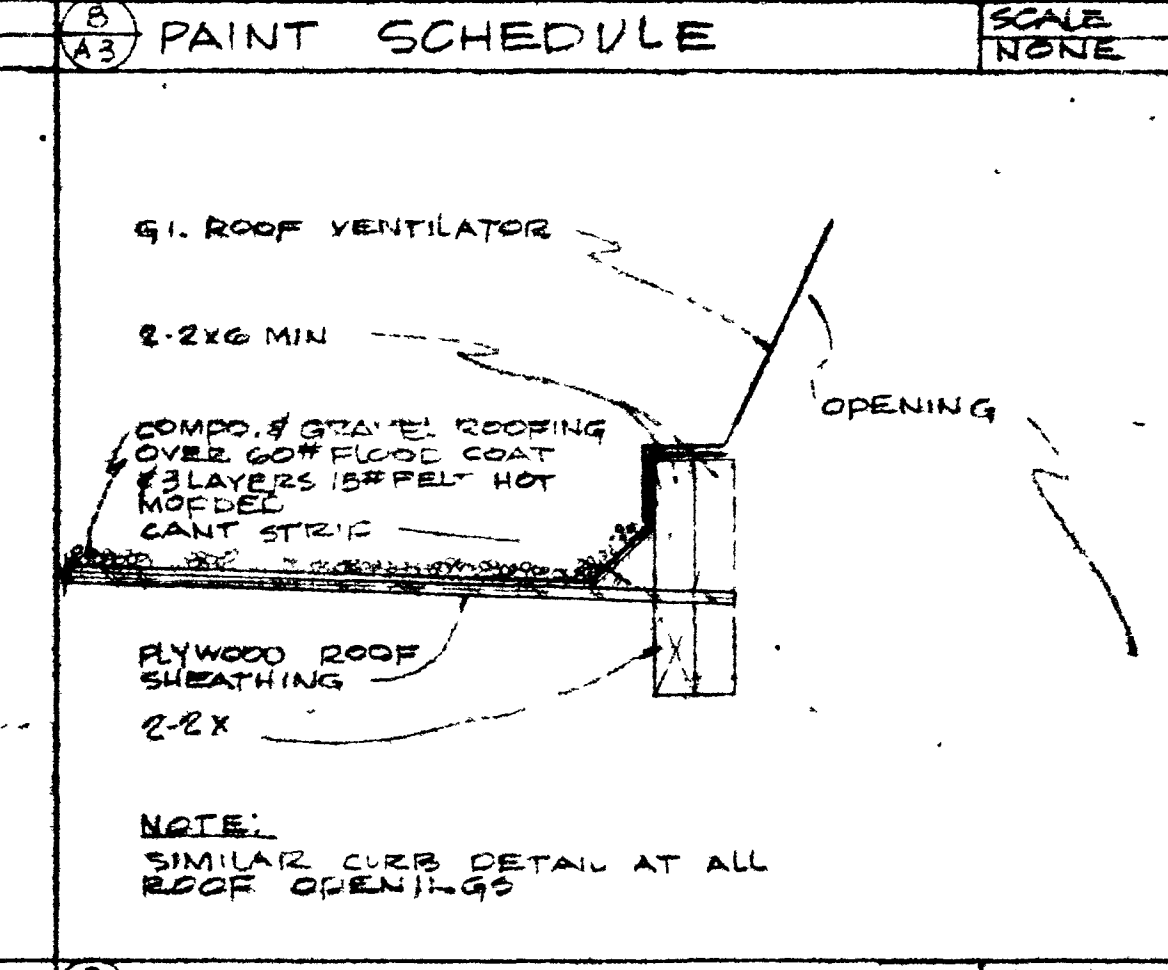
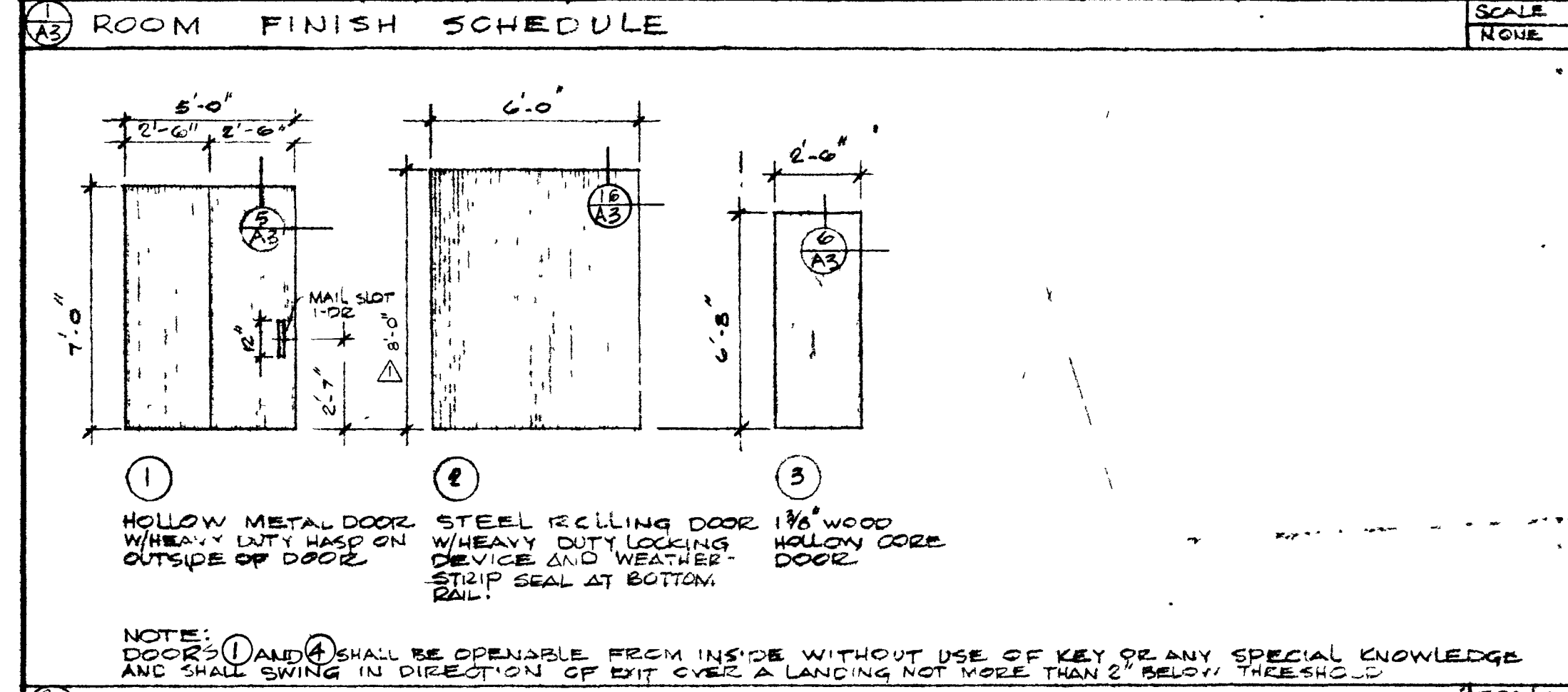
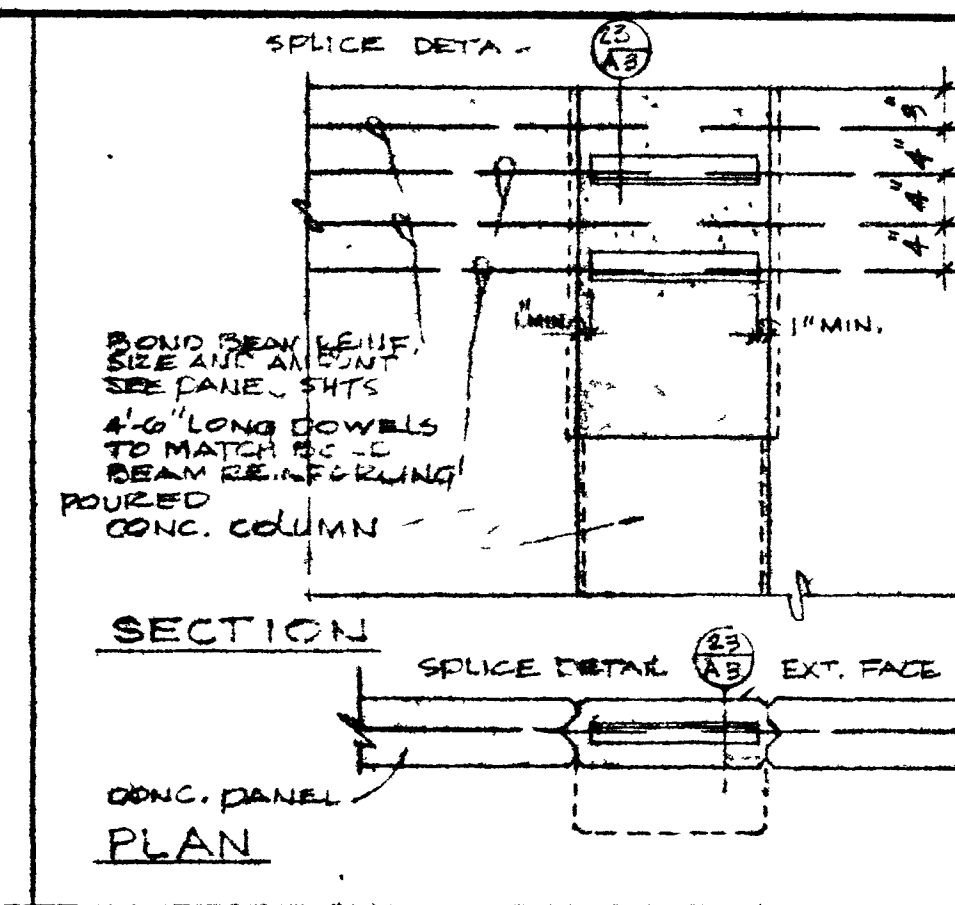
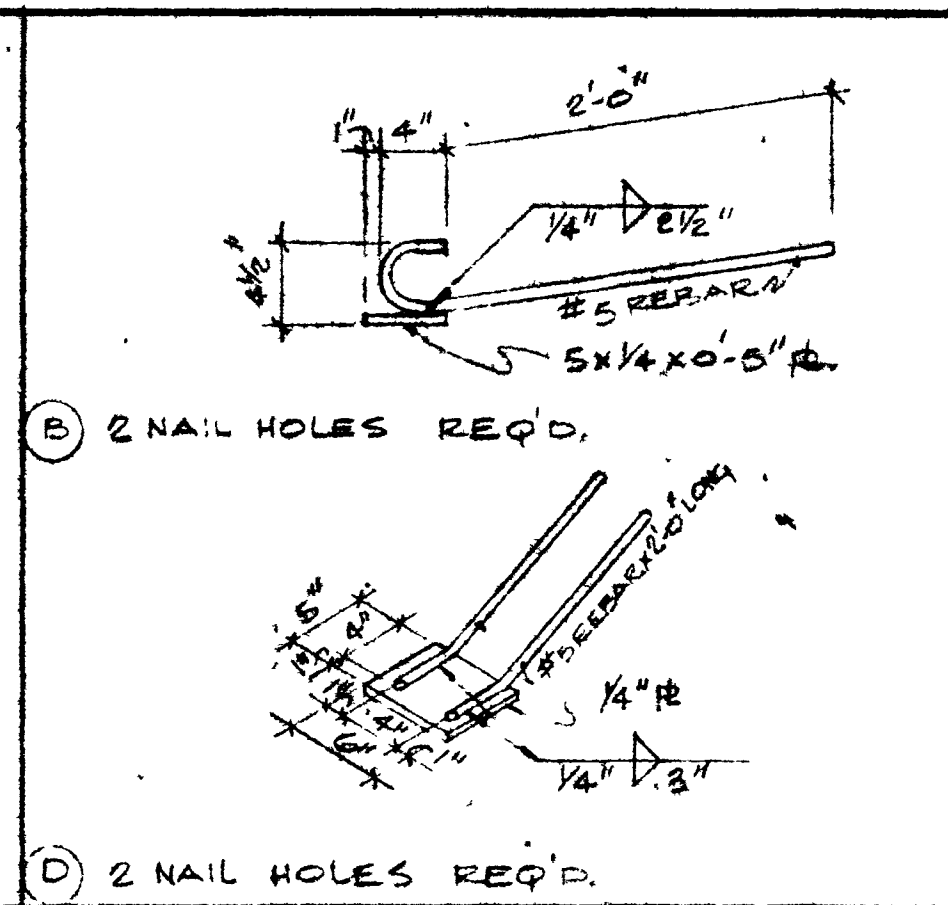
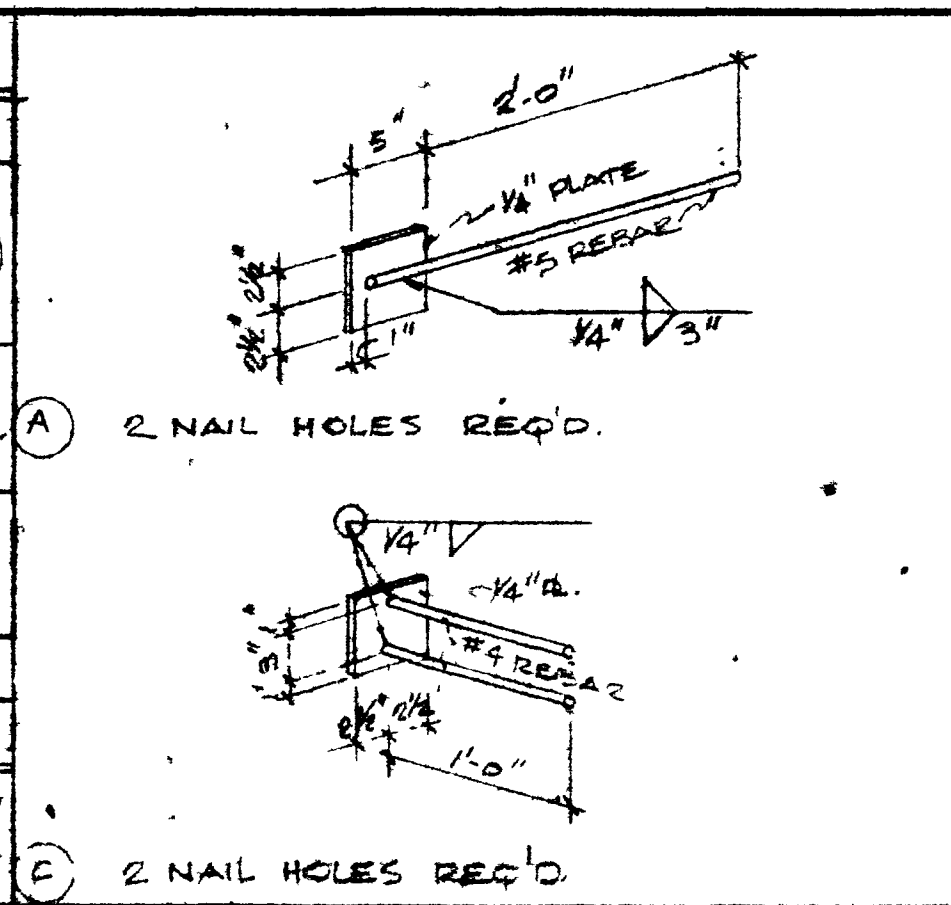