

DESIGNED BY:	RF	DRAWN BY:	SW	CHKD BY:	H
JOB NUMBER:	693-003-963	DATE:	7-21-98	REVISION:	
NO.	1	REPLACE EXIST. CHAIN LINK FENCE W/ WROUGHT IRON FENCE	DATE	7/21/98	
NO.	2	ADD TACE-ON ISLAND OPTION PER DWG. NO. 221	DATE	7/21/98	

L. R. NELSON CONSULTING ENGINEERS, INC.
 3035 East Patrick Lane Suite 9
 Las Vegas, Nevada 89120
 (702) 798-7978
 (702) 451-2296 FAX

• STRUCTURAL
 • CIVIL
 • SURVEY

NEVADA
CORPORATE CENTER
 BORMAN DEVELOPMENT
 CITY OF LAS VEGAS

DETAIL SHEET
9
 OF 12 SHEETS
 693-003-963

107-12837

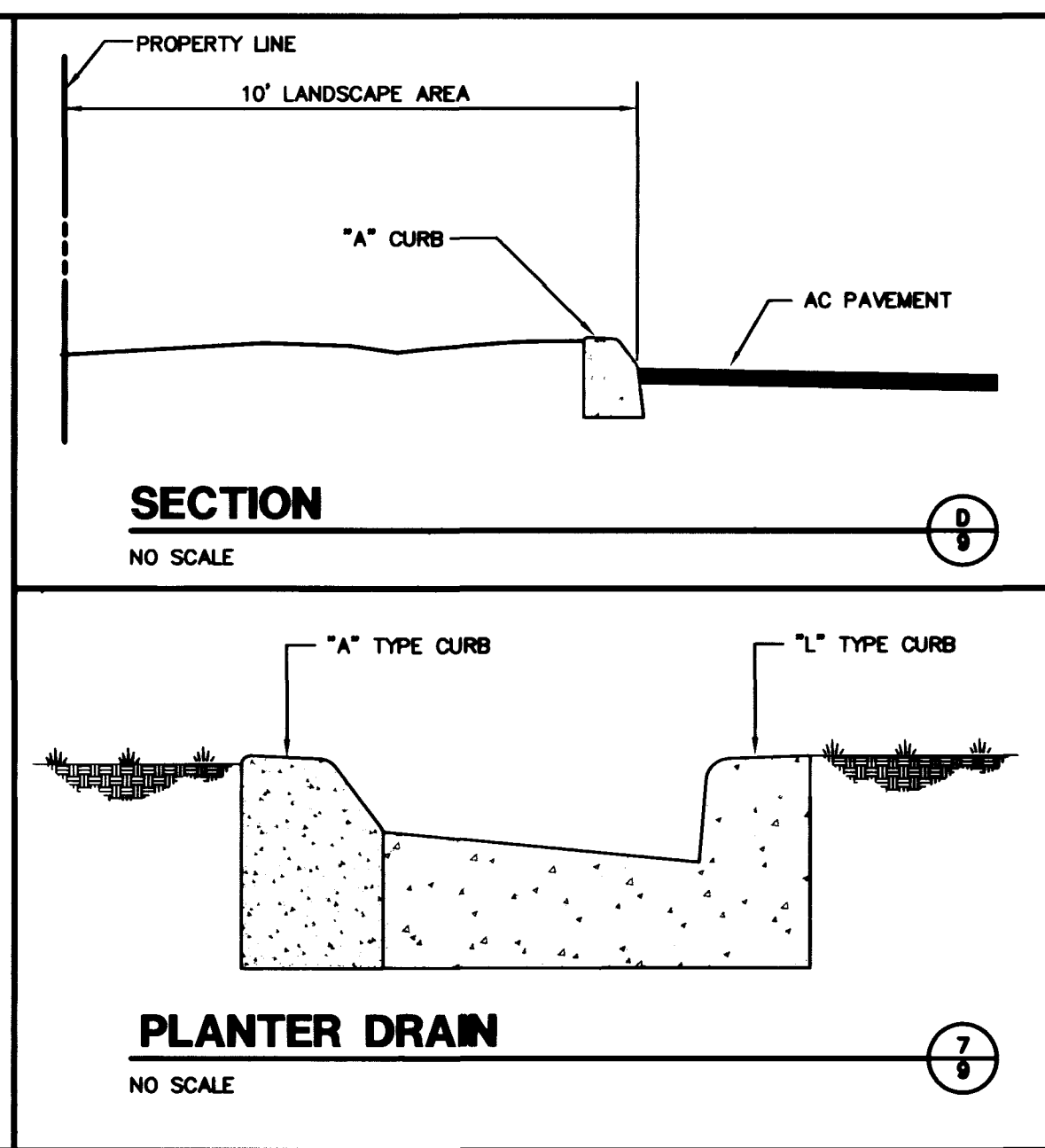
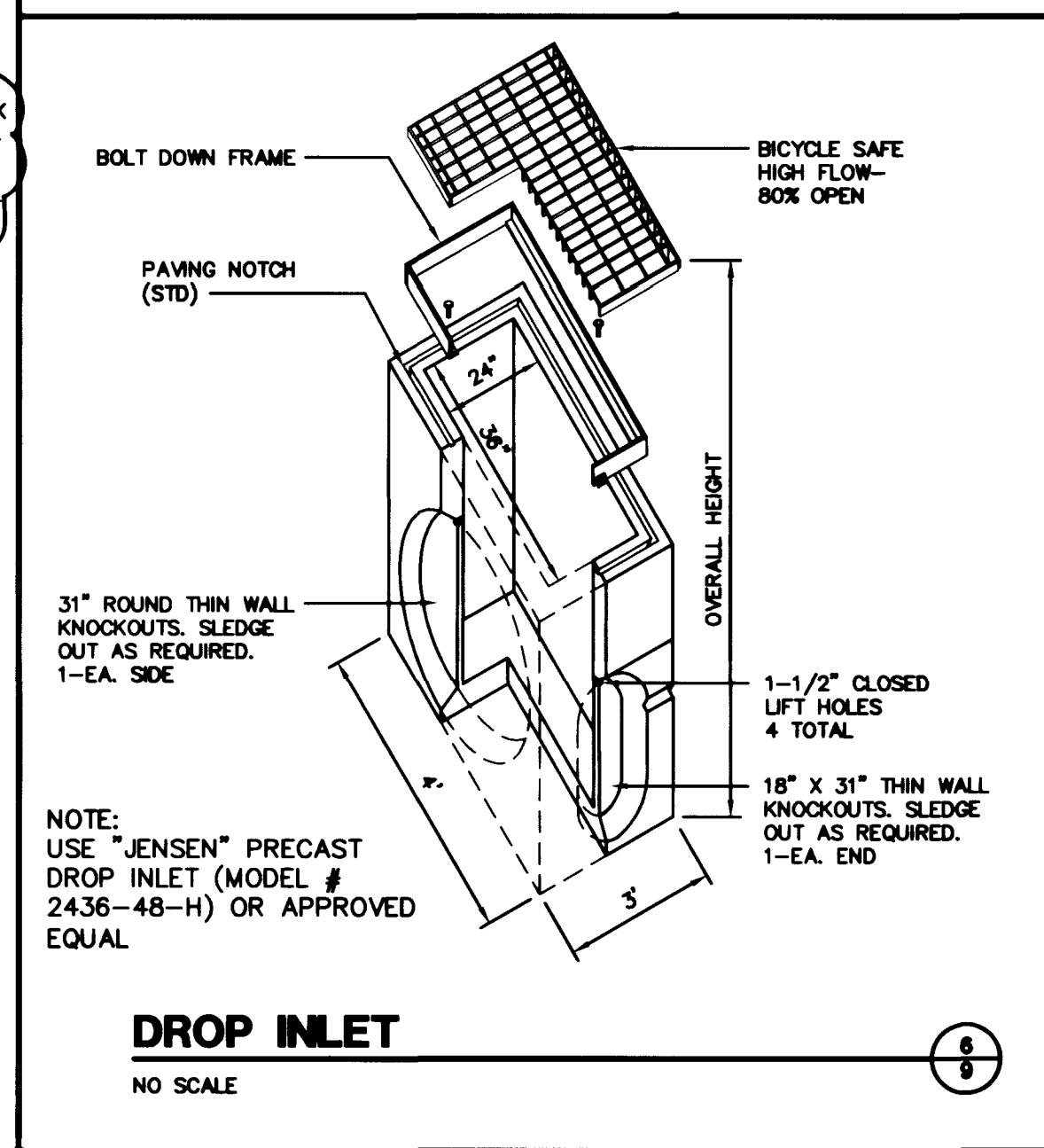
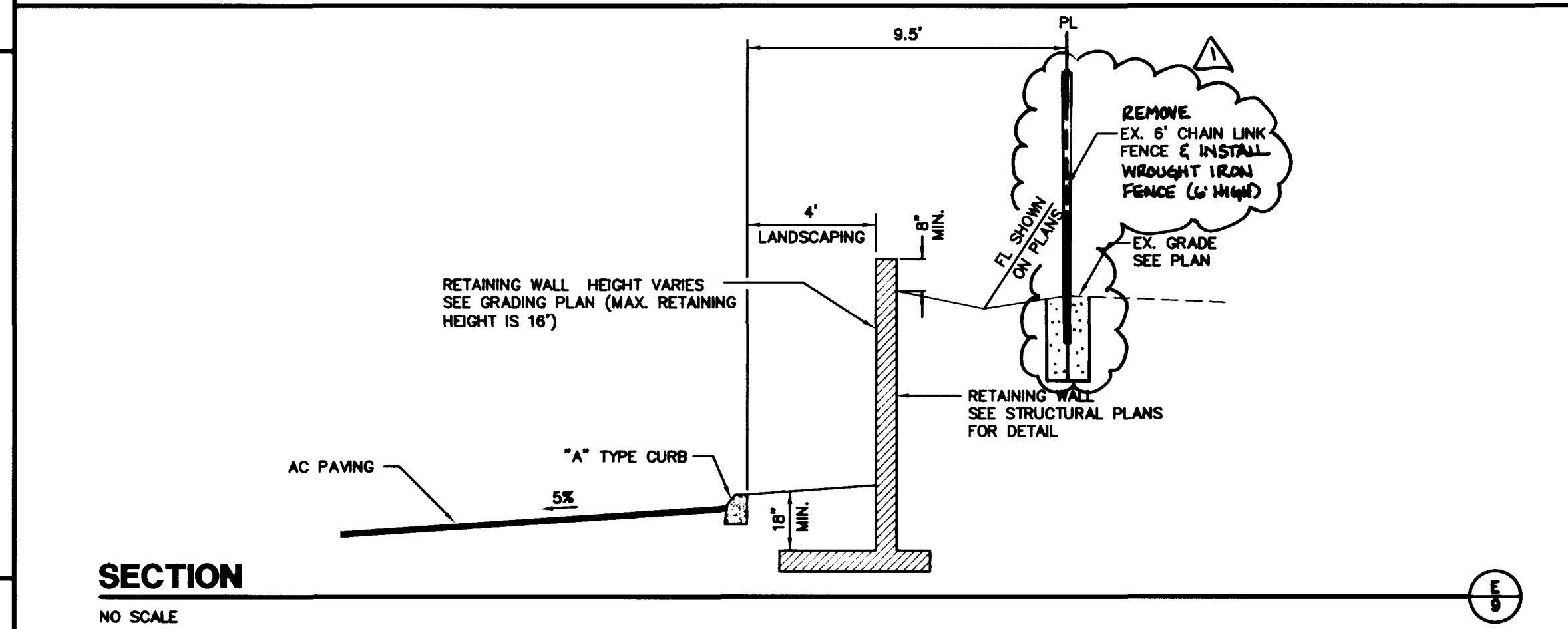
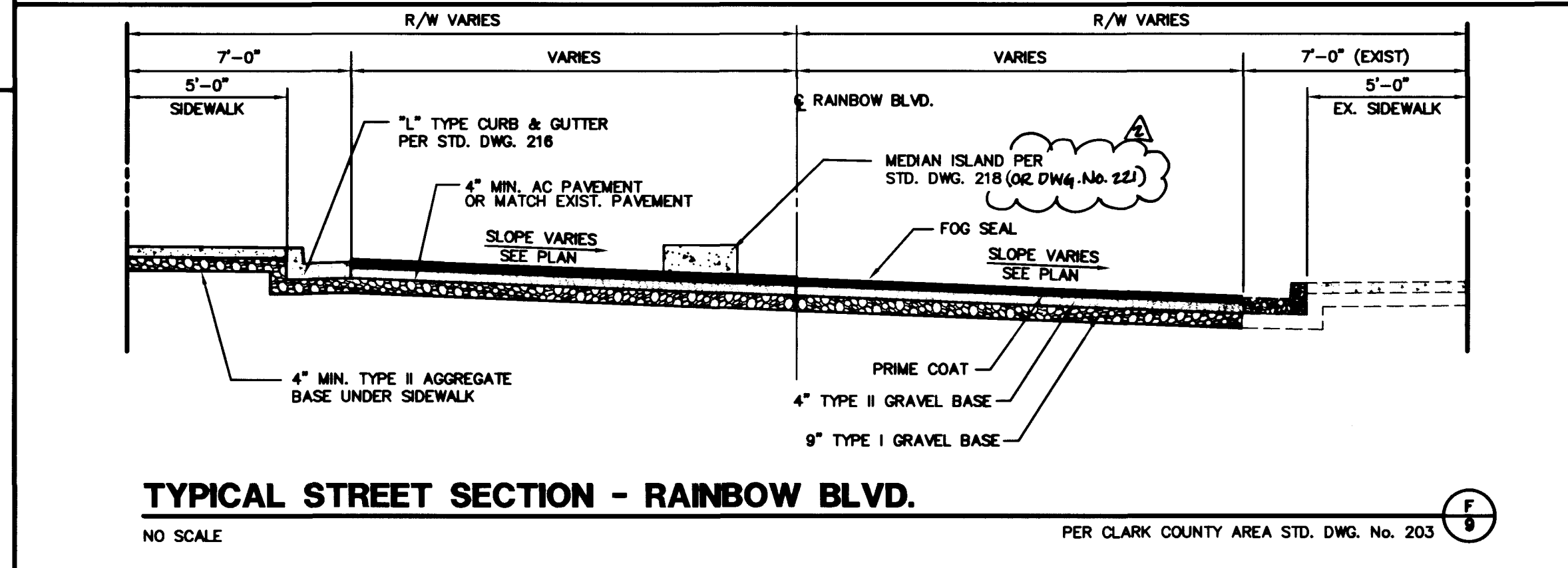
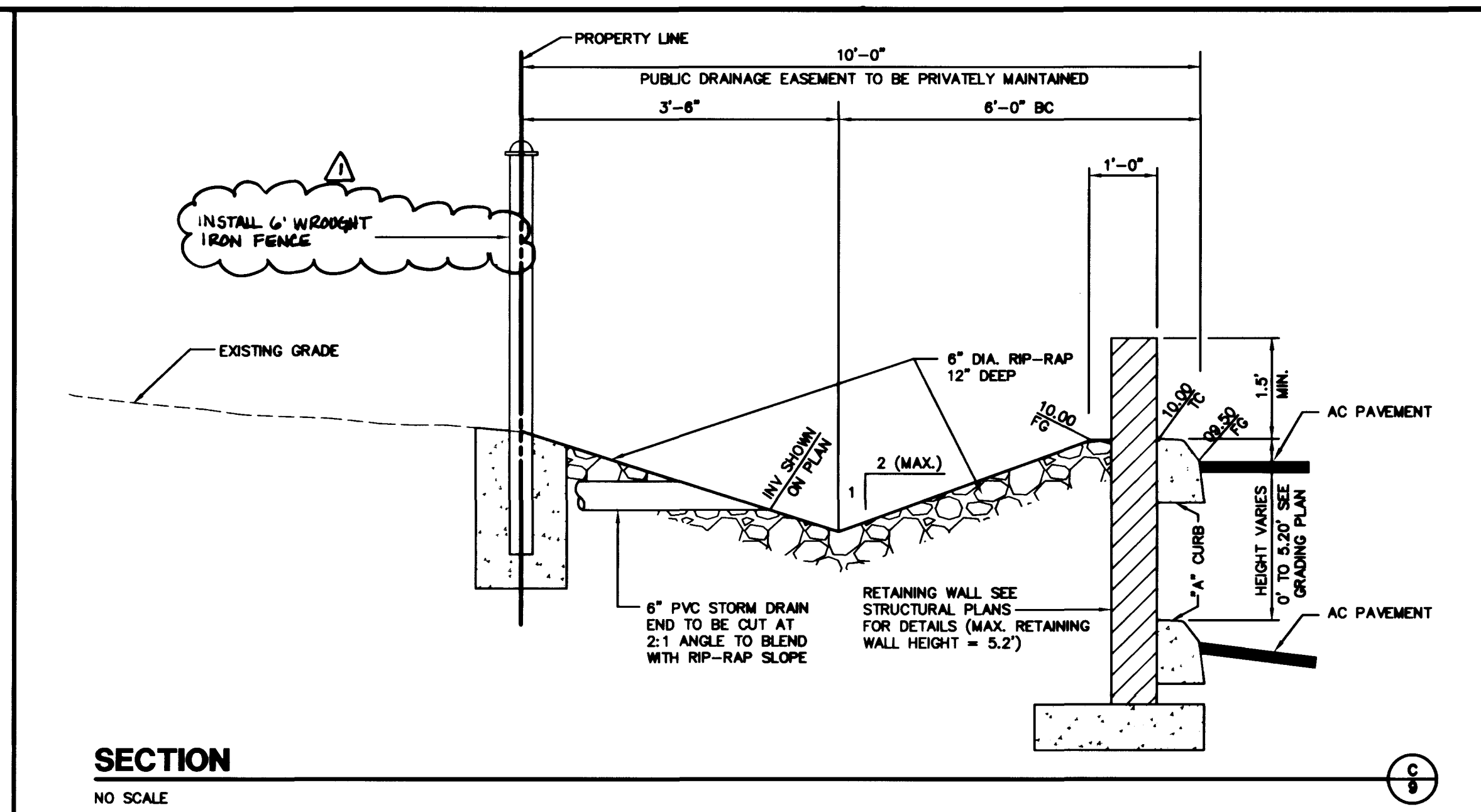
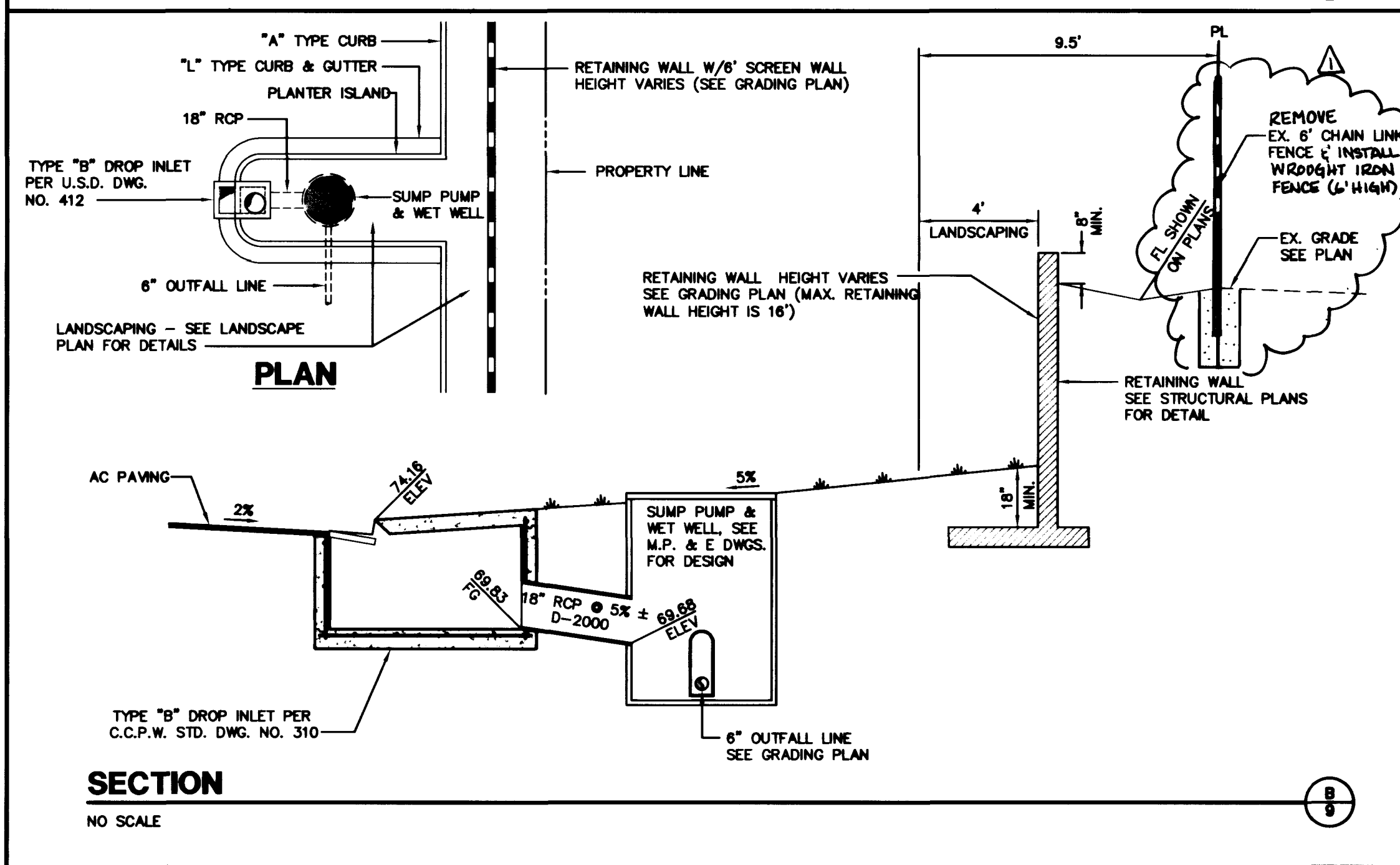
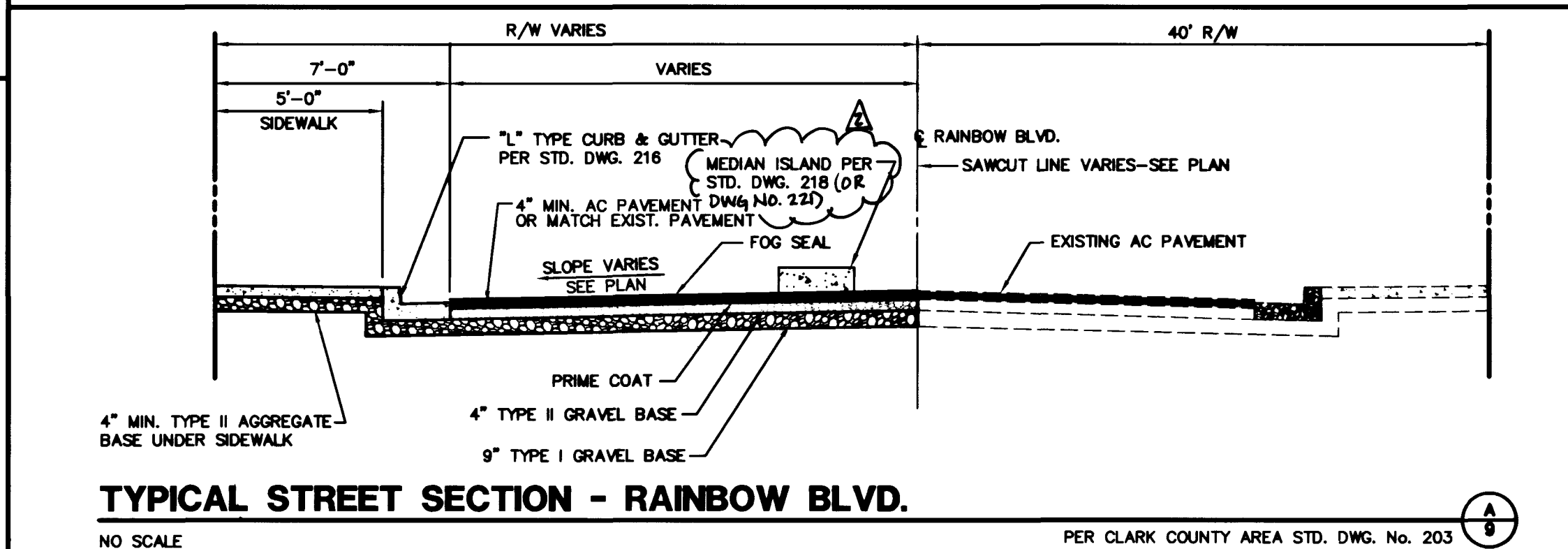
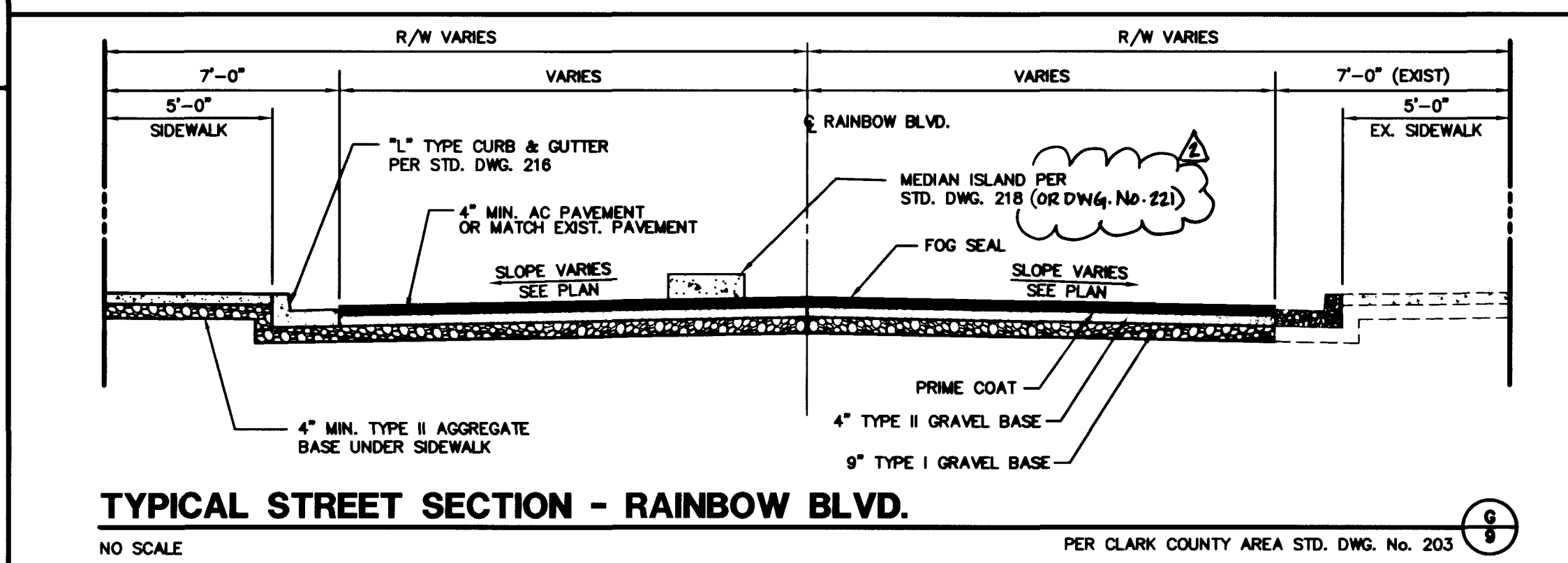
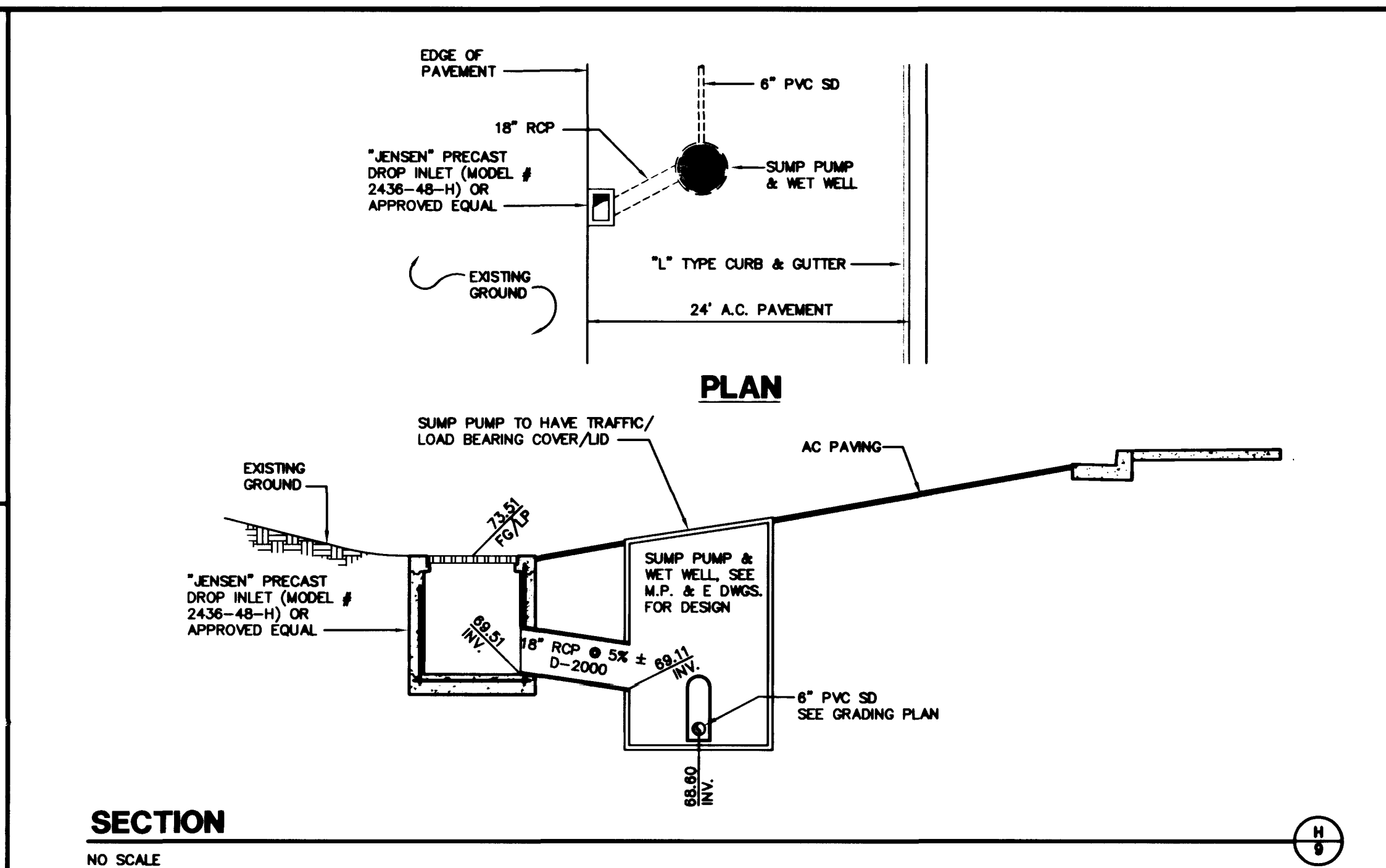
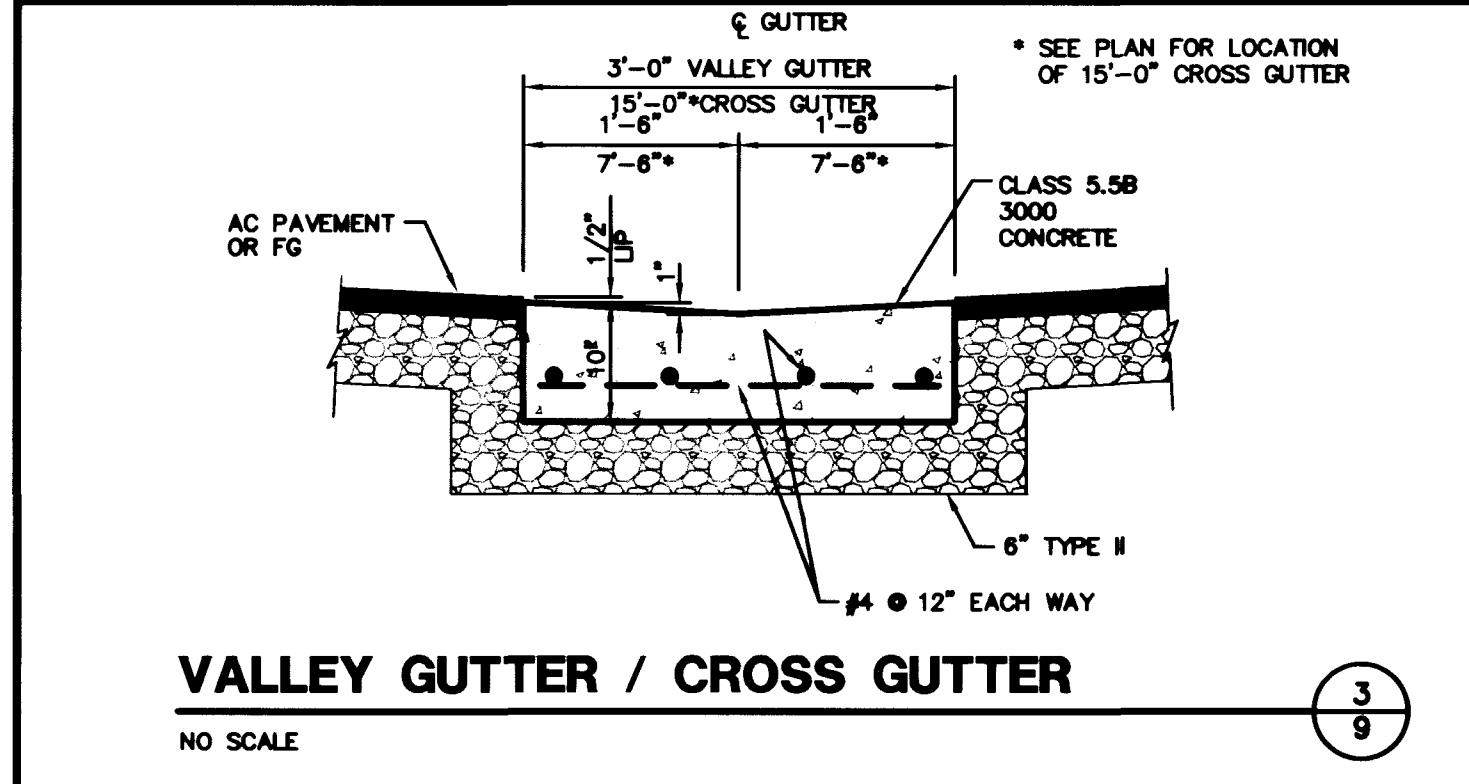
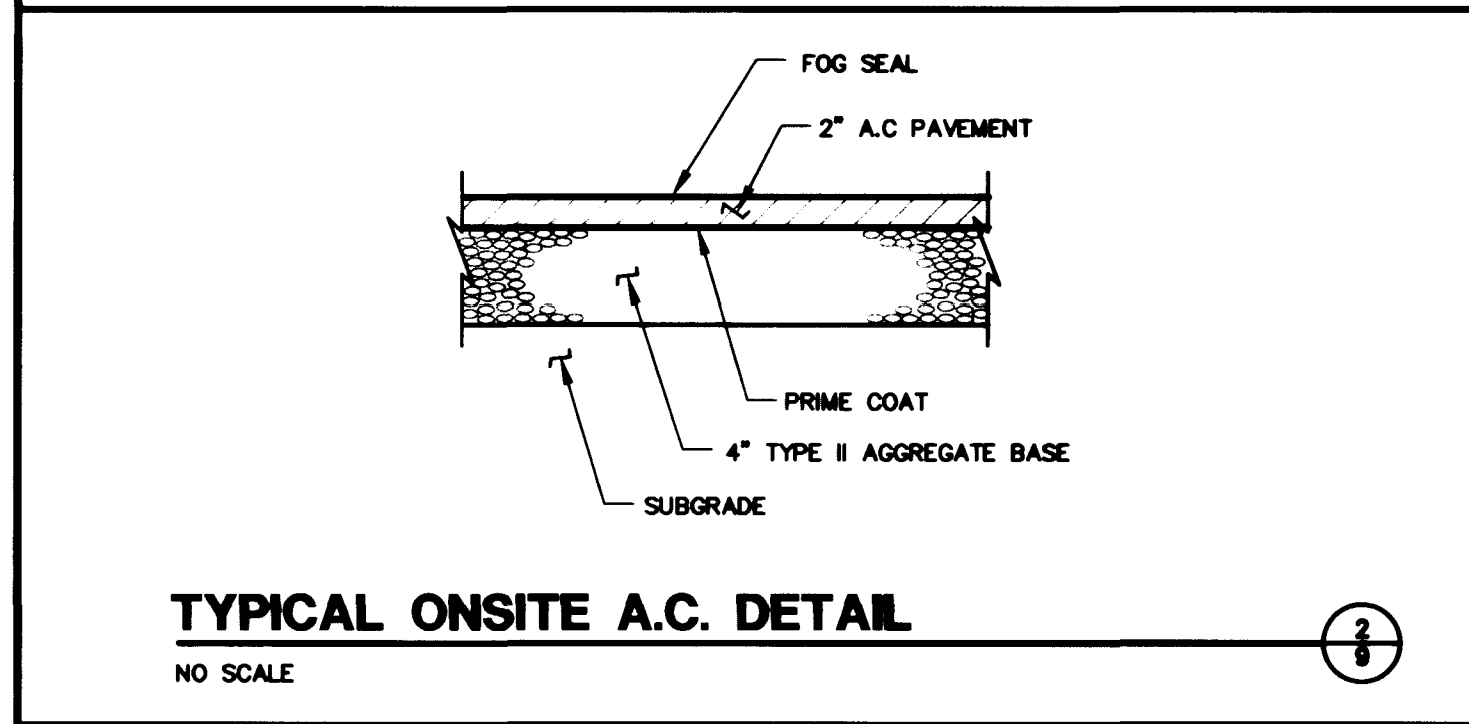
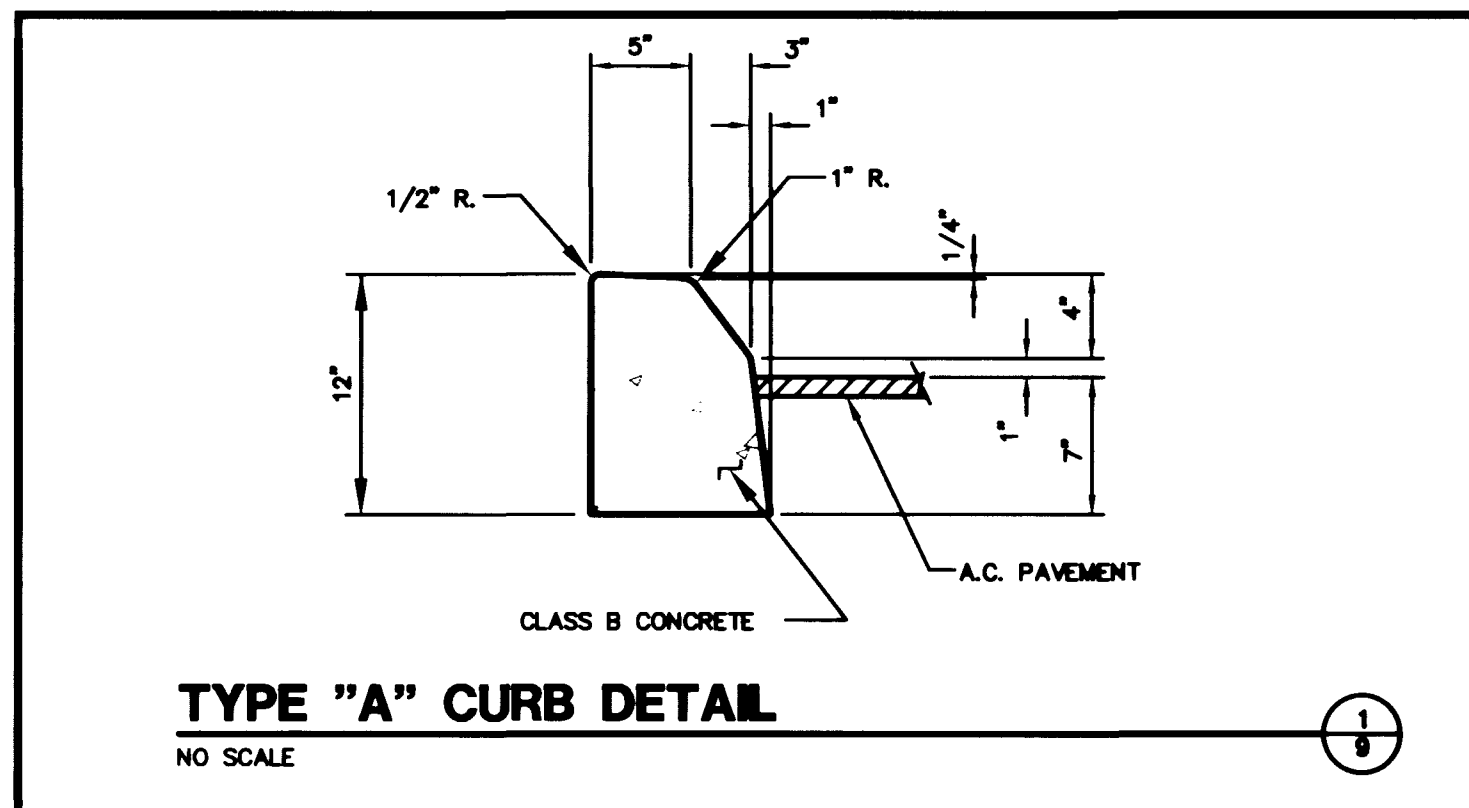

H:\Projects\6600\693003\DMG\RCC-DET Thu Aug 27 09:25:50 1998 BY CAROL SCOTT

DRAWING NAME: RCC-DET LATEST PLOT DATE

10106 11928 13576



TYPICAL CURB DETAIL



TYPICAL CURB AND GUTTER DETAIL



VALLEY GUTTER / CROSS GUTTER

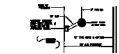

TYPICAL STREET SECTION - NARROW GUTTER



TYPICAL STREET SECTION - NARROW GUTTER



TYPICAL STREET SECTION - NARROW GUTTER

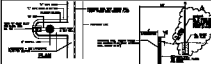

TYPICAL STREET SECTION - NARROW GUTTER

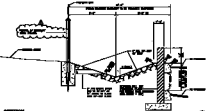

TYPICAL STREET SECTION - NARROW GUTTER



TYPICAL STREET SECTION - NARROW GUTTER



TYPICAL STREET SECTION - NARROW GUTTER

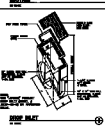

TYPICAL STREET SECTION - NARROW GUTTER



TYPICAL STREET SECTION - NARROW GUTTER



TYPICAL STREET SECTION - NARROW GUTTER



DATE	BY	CHECKED

PROJECT NAME	
PROJECT NO.	
DATE	

ALL RIGHTS RESERVED
 COPYRIGHT © 2000
 BY THE AUTHOR
 ALL RIGHTS RESERVED



ALL RIGHTS RESERVED. THIS DOCUMENT IS THE PROPERTY OF THE AUTHOR.