

SECTION A - ACACIA TREE

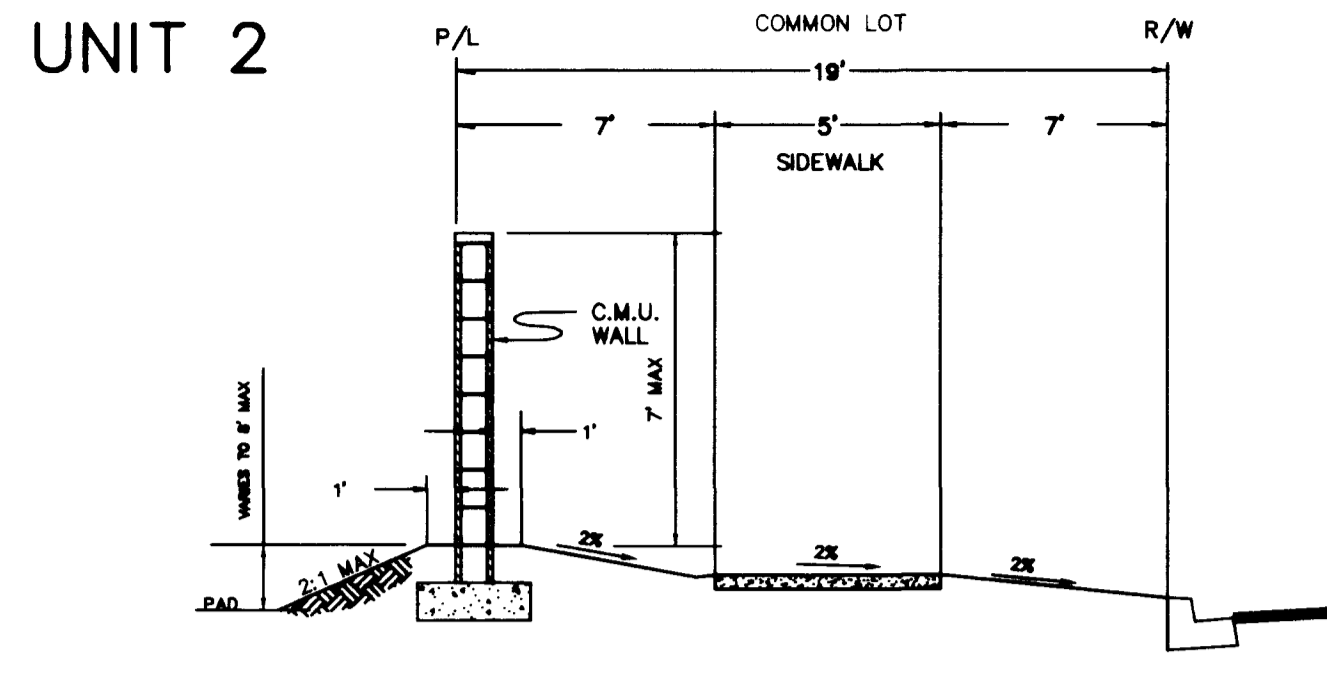

SECTION B - ACACIA TREE

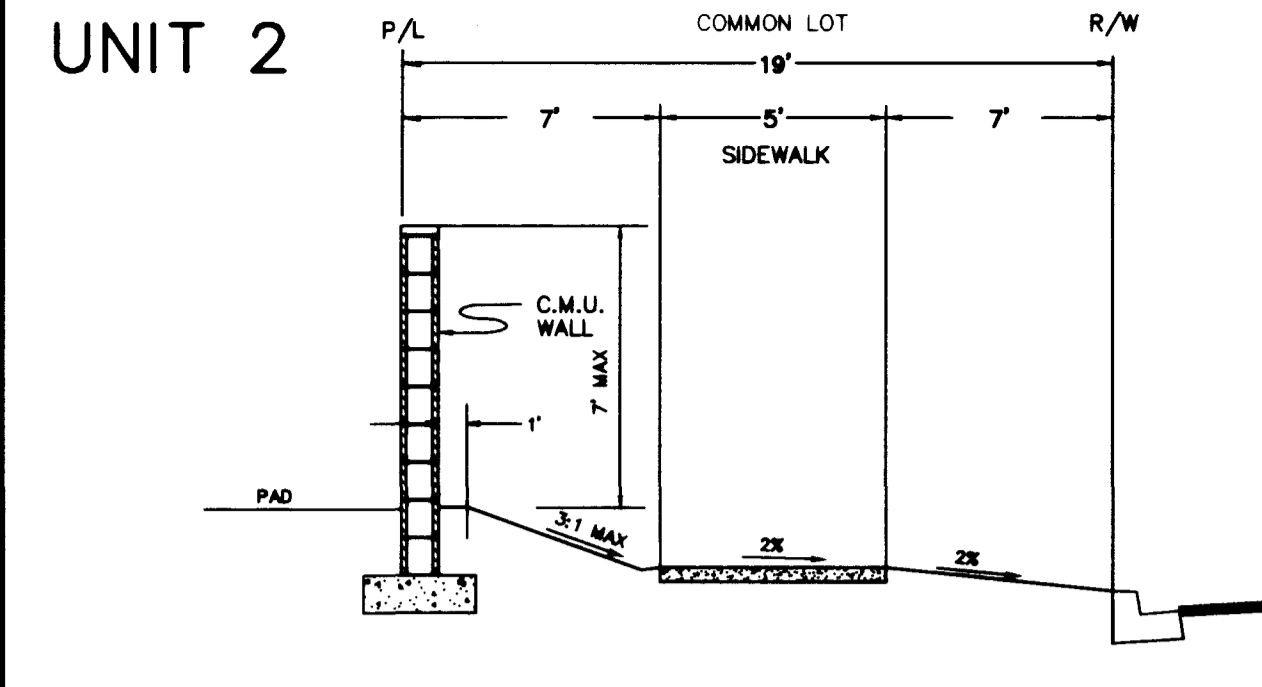

SECTION Q - ACACIA TREE

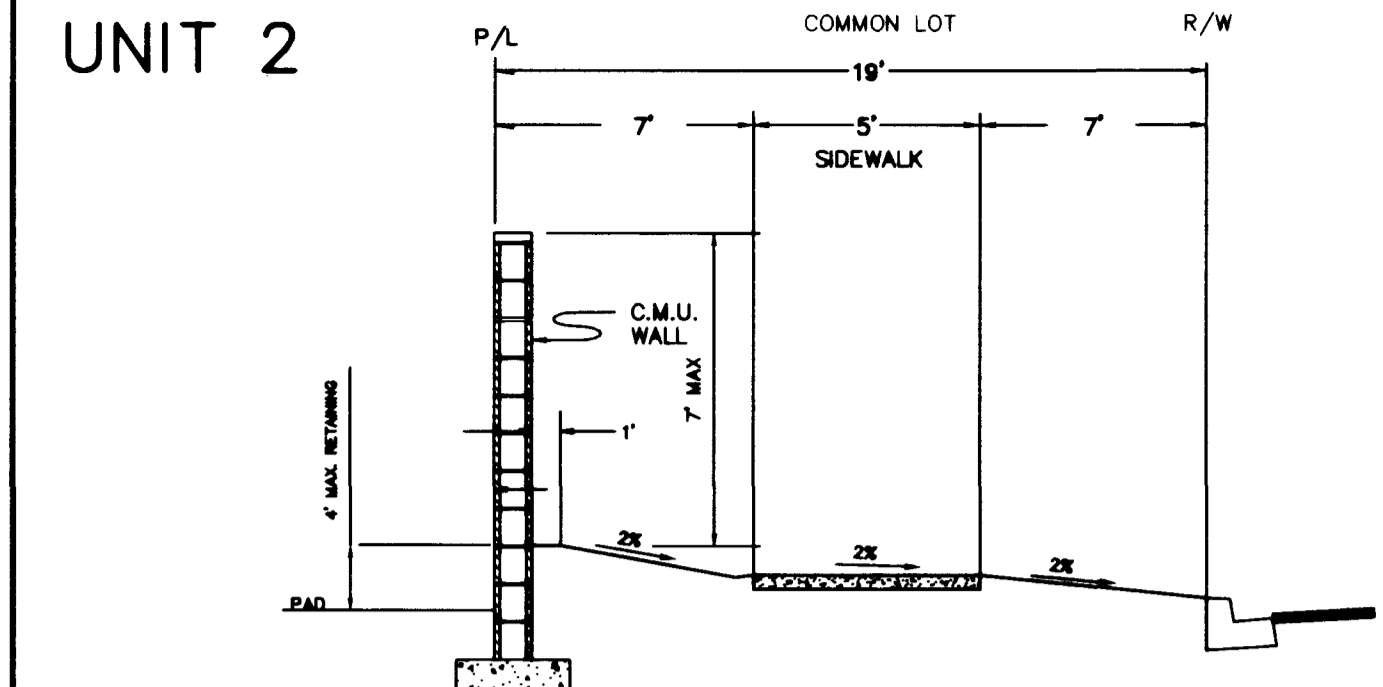

SECTION R - ACACIA TREE

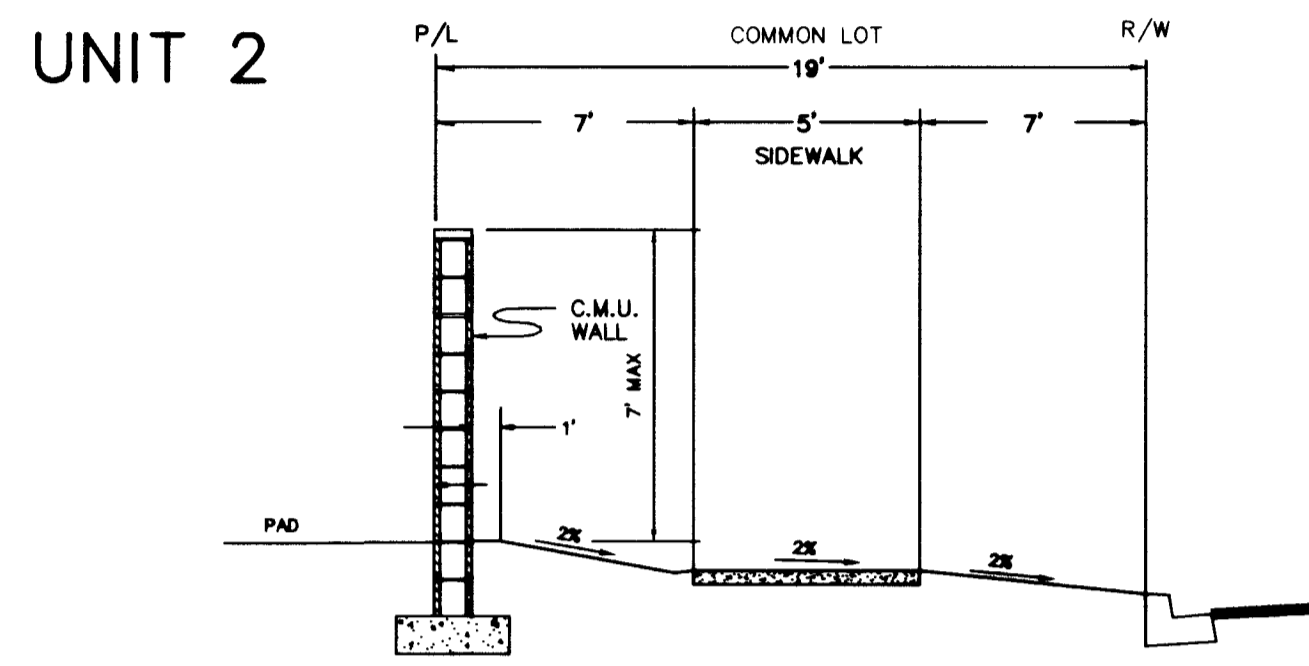

SECTION X - ACACIA TREE

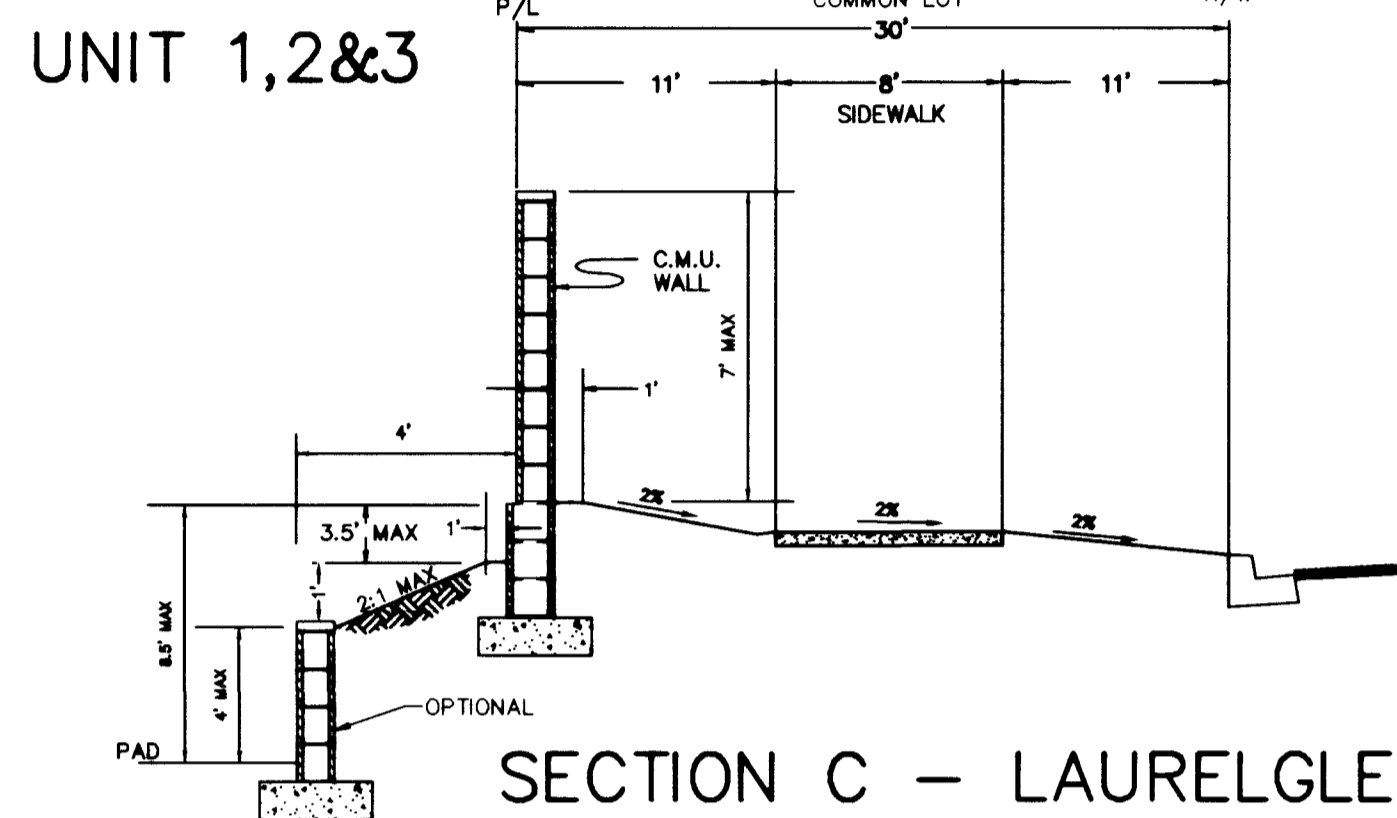

SECTION C - LAURELGLEN

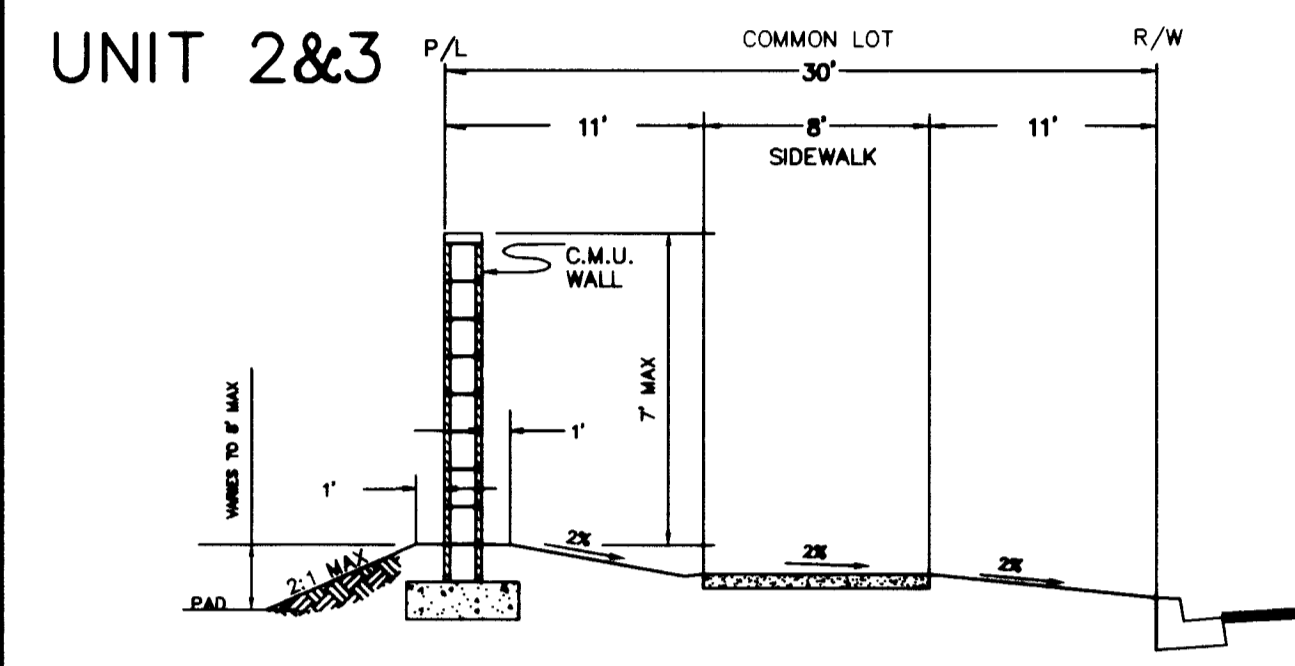

SECTION D - LAURELGLEN

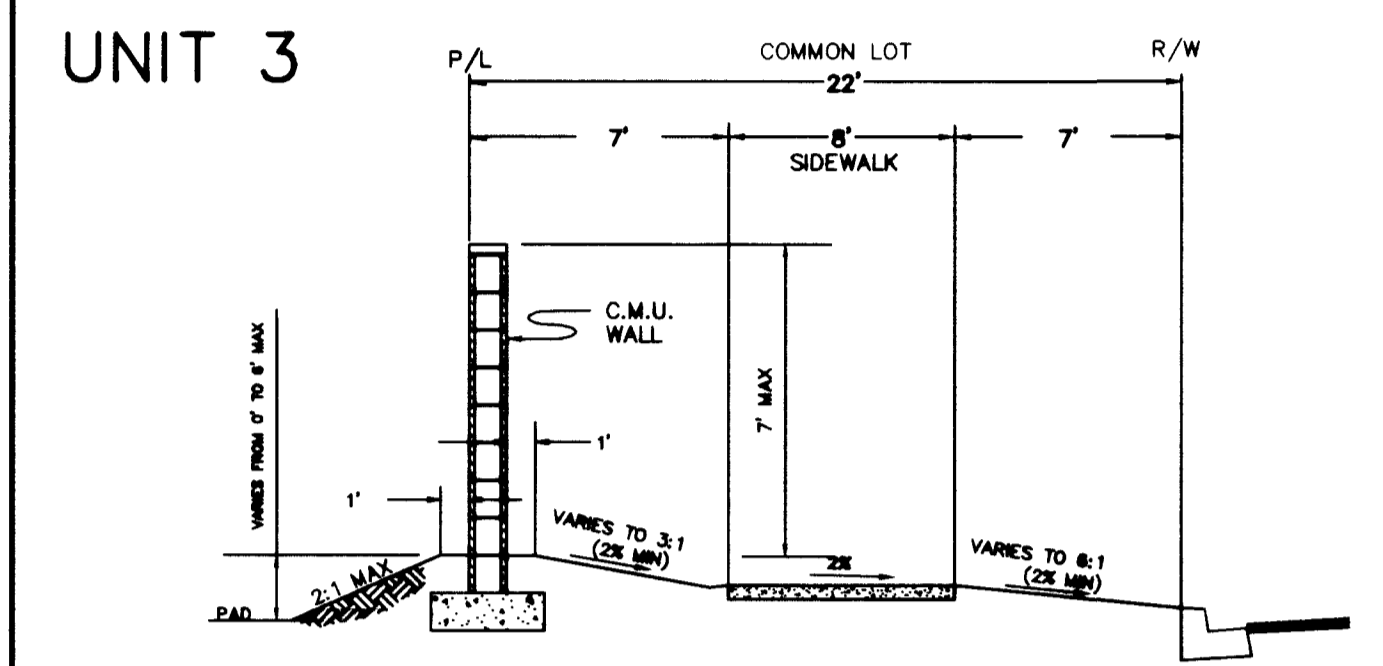

SECTION E - FAR HILLS

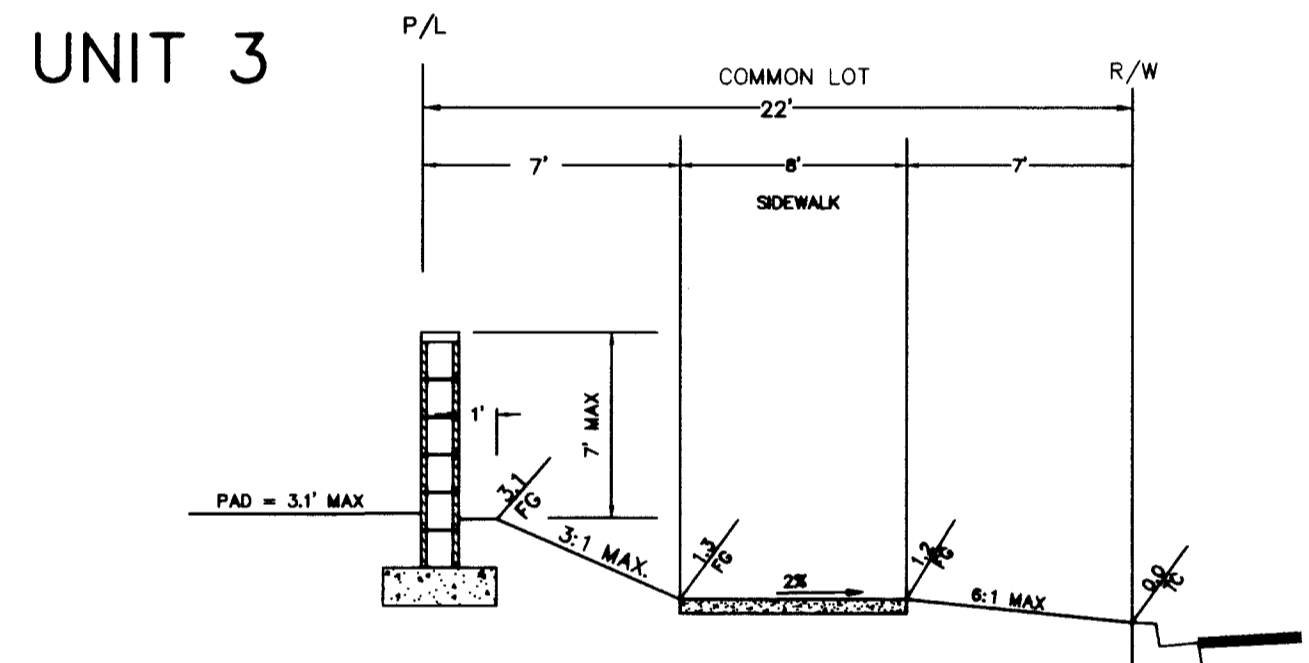

SECTION F - FAR HILLS

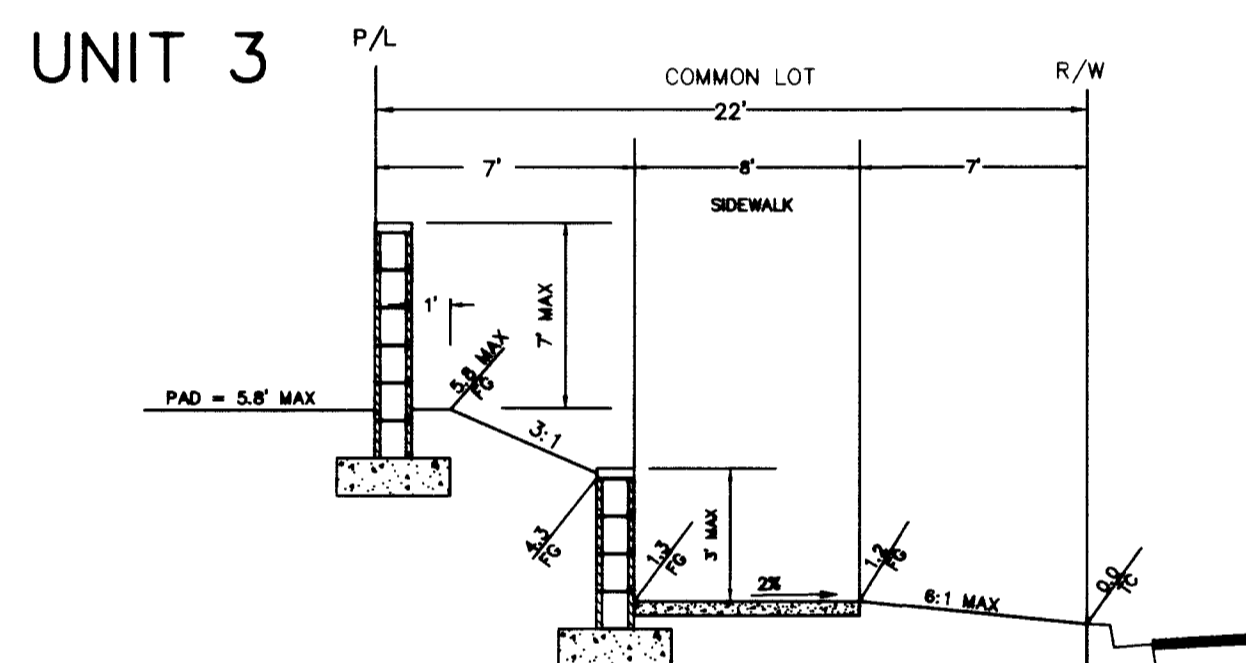

SECTION G - FAR HILLS

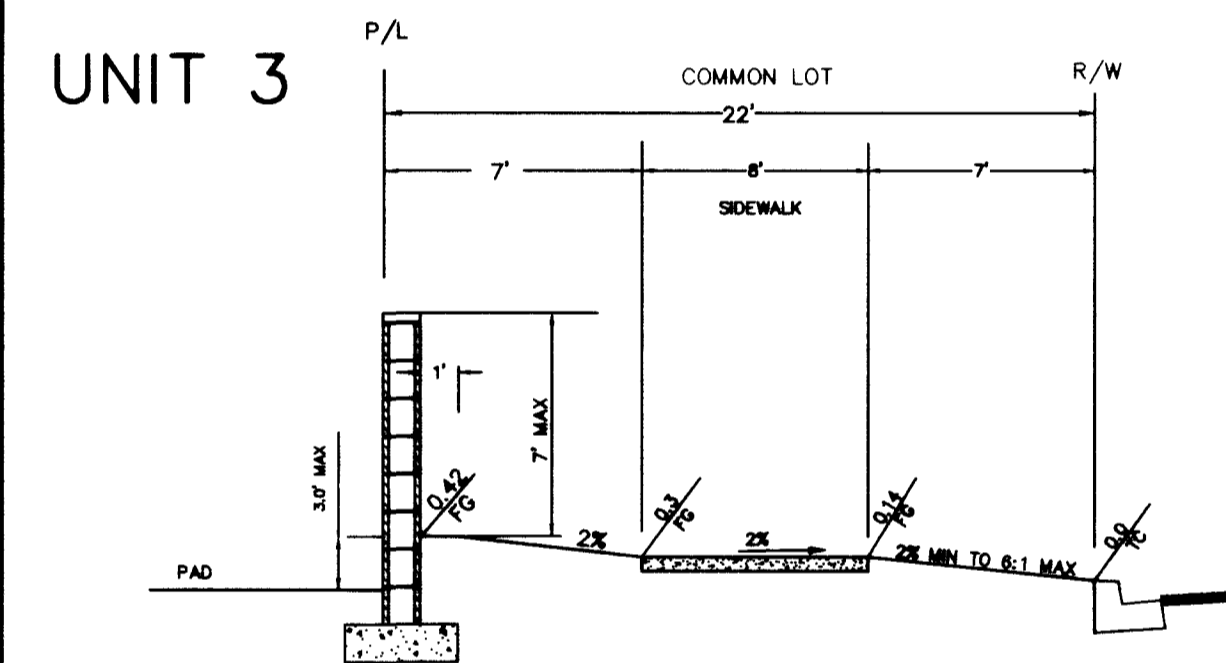

SECTION S - FAR HILLS

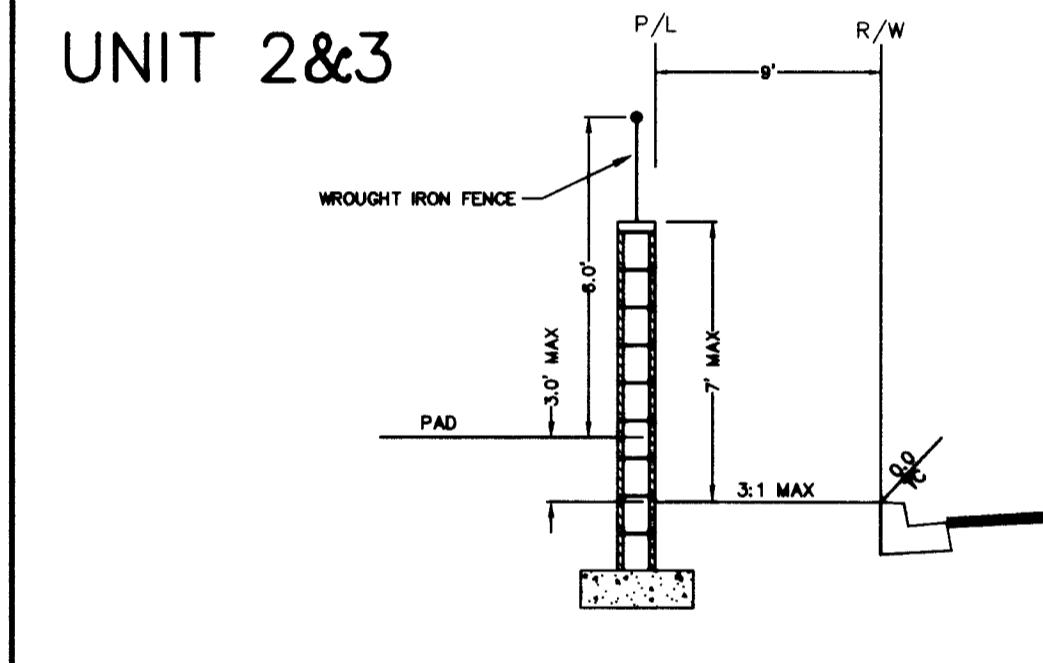

SECTION L

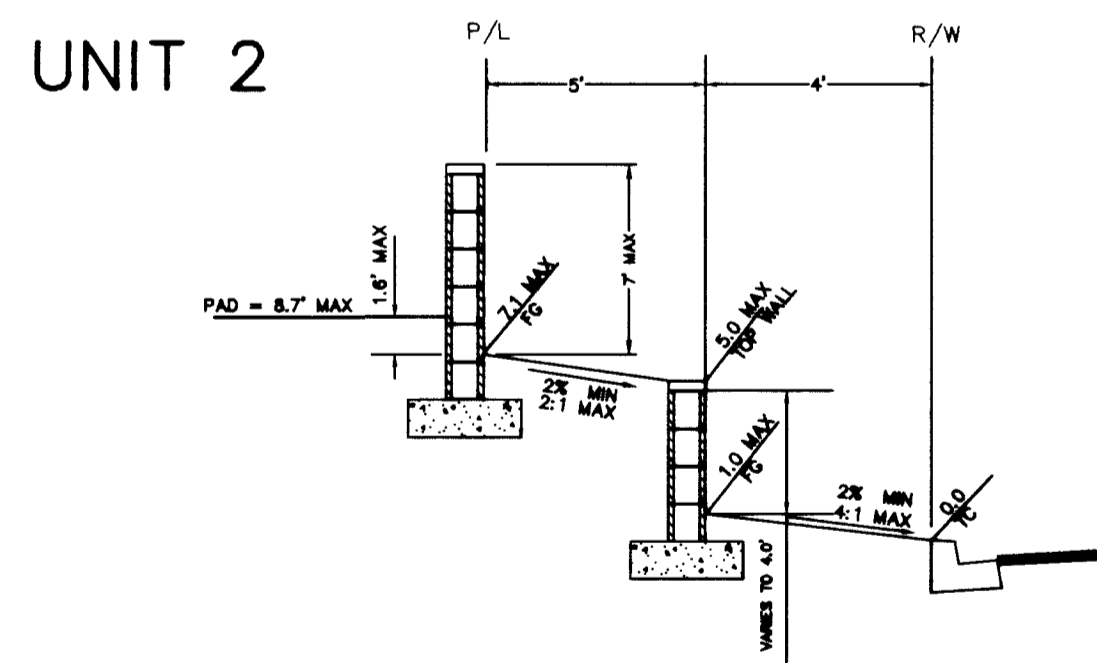

SECTION I

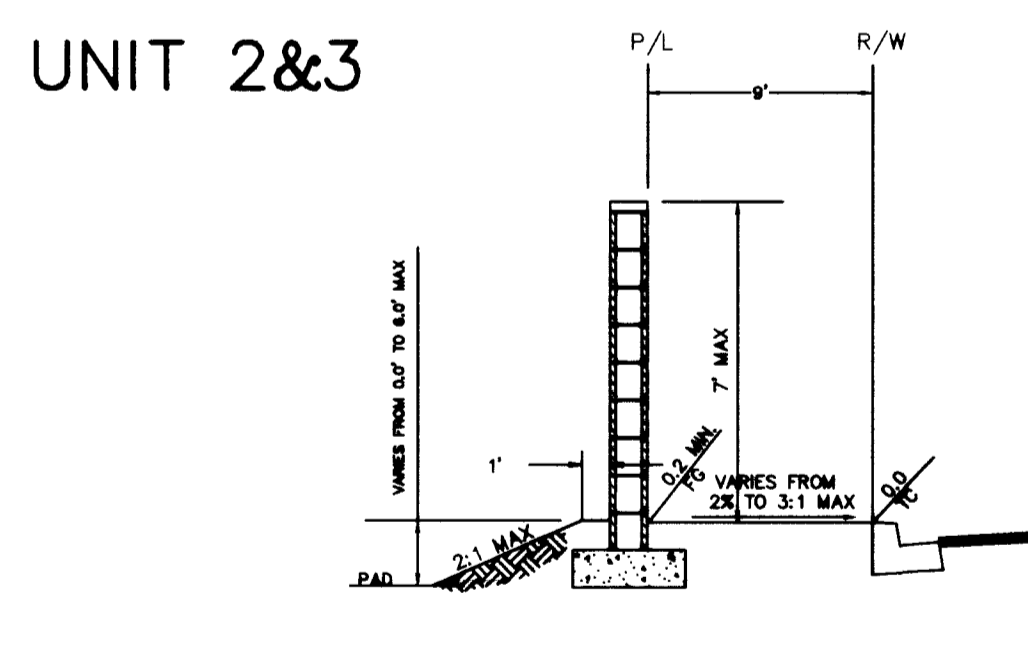

SECTION J

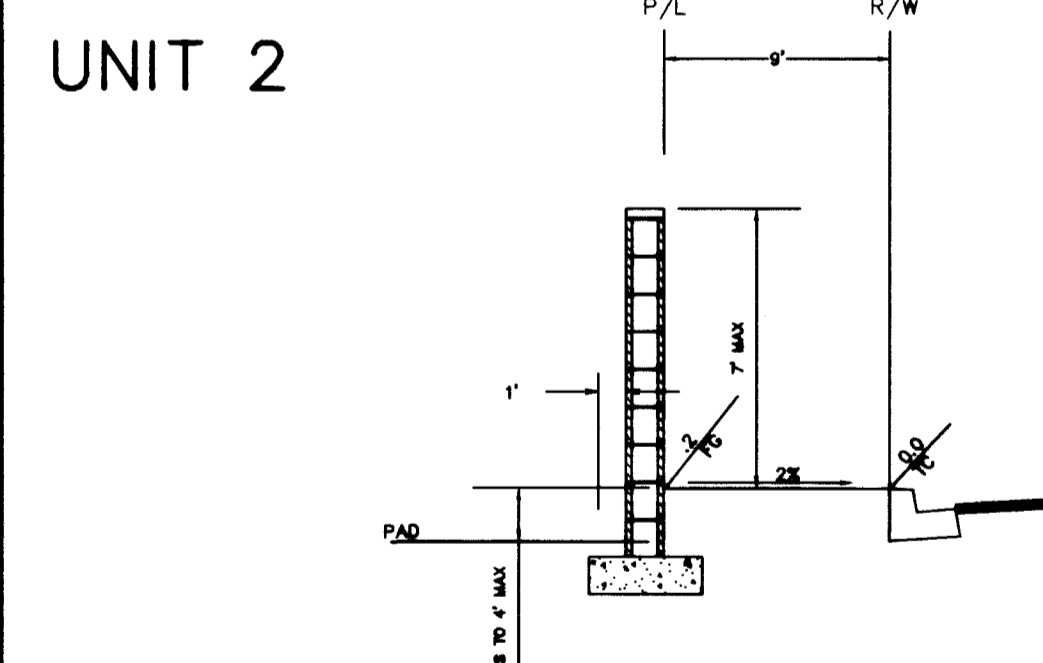

SECTION K

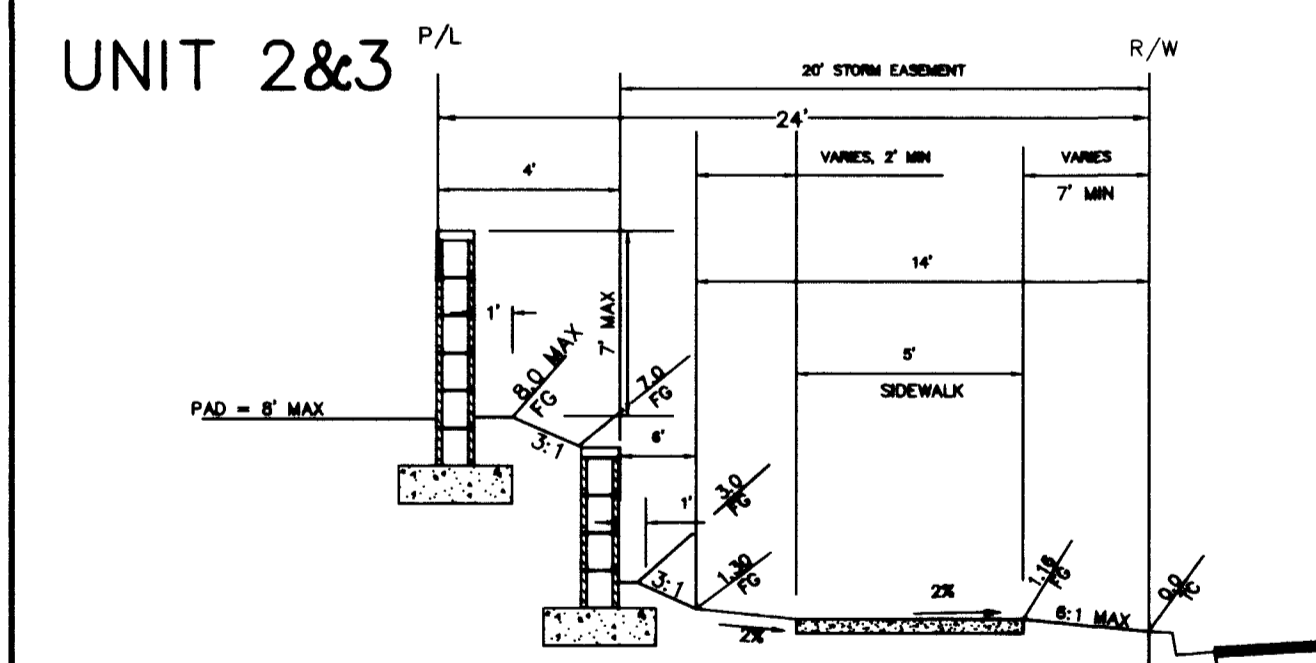

SECTION H - ANASAZI

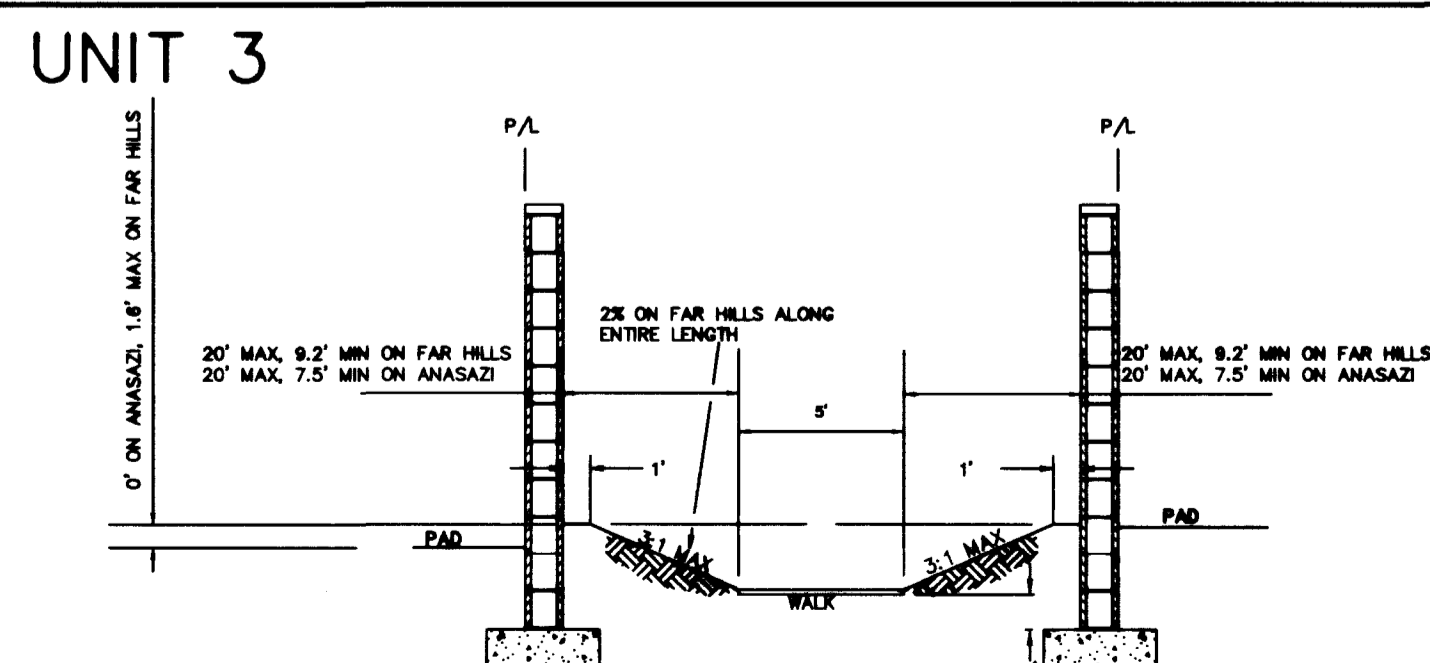

SECTION M

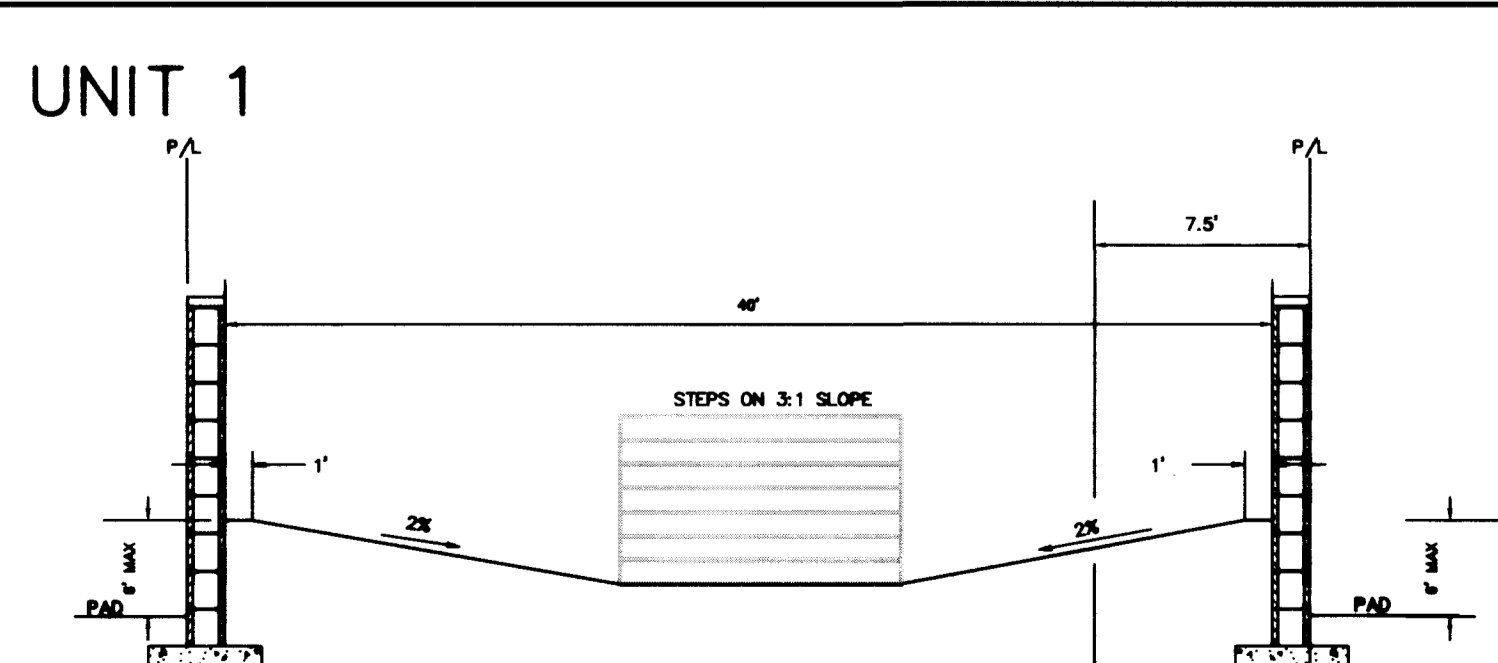

SECTION N

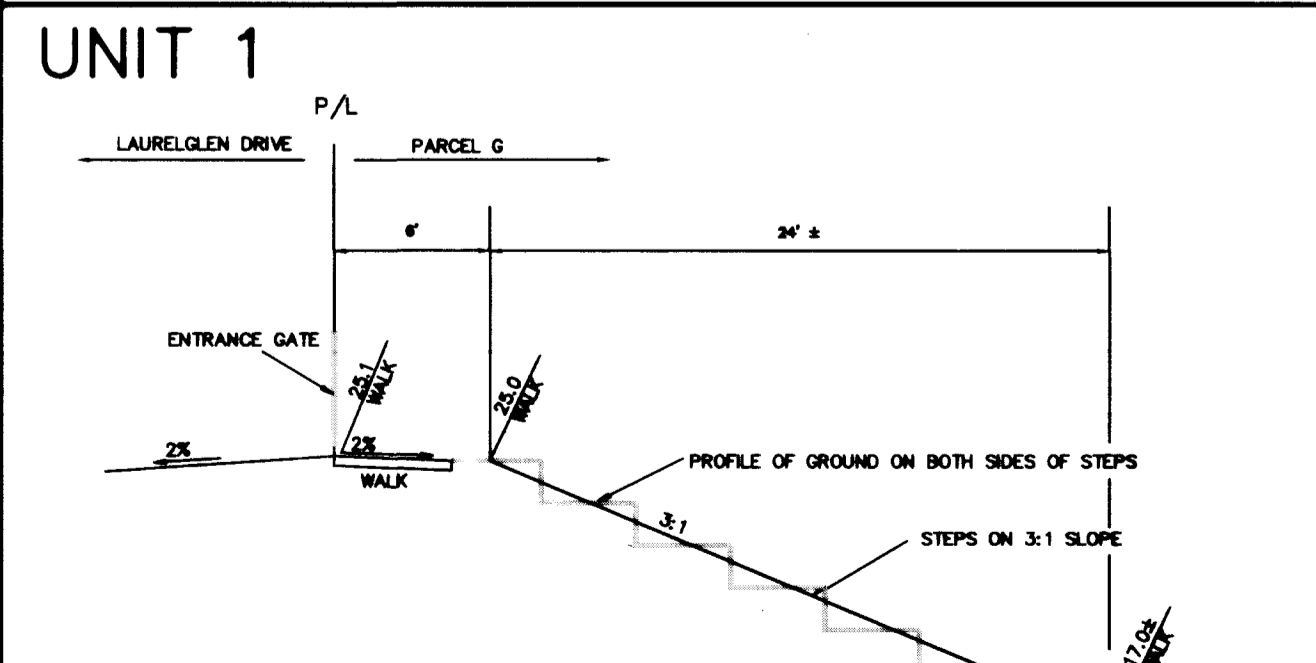

SECTION O

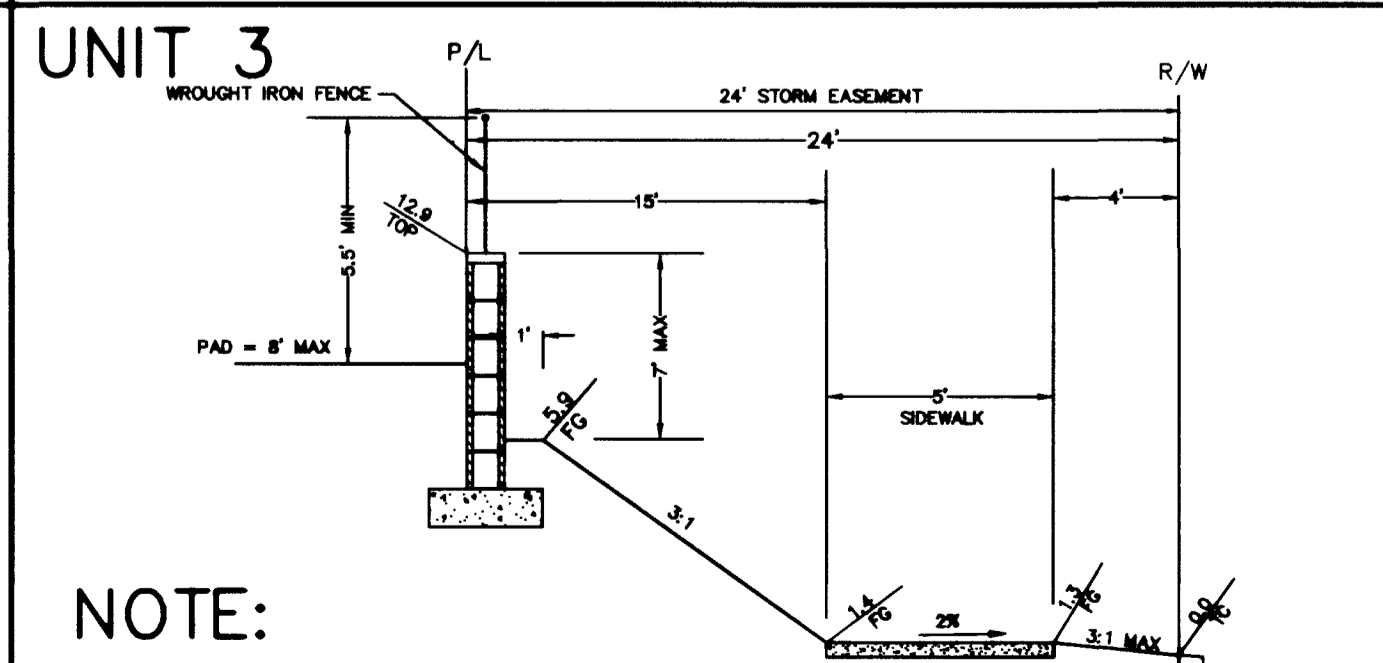

SECTION P - ANASAZI

NOTE:  
BLOCK WALLS AND RETAINING WALLS ARE SHOWN FOR REFERENCE ONLY, AND ARE TO BE DESIGNED BY OTHERS.

DRAWING NO: 2903nts

REVISIONS

NO.	DATE	BY	APPROVED
1	6/7	HAILIN LI	

PROJECT: REVISED NEW STREET WALLS

ENGINEER: EDWARD TANKI

PROFESSIONAL ENGINEER - STATE OF NEW YORK

EDWARD TANKI

NO. 14, JEROME AVENUE, NEW YORK, N.Y. 10017

TELEPHONE: (212) 677-1000

ALPHA ENGINEERING COMPANY

50 St. Jerome Ave., New York, NY 10017

Telephone: (212) 677-1000

ROYAL WOODS - UNIT 1

DETAIL SHEET

PRESLEY HOMES

JOB NO: 712903

NAME: HAILIN LI

DATE: 11.24.97

SCALE: NO SCALE

PAGE: D1

10 of 11

W26

107Y-4538-1

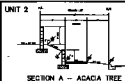

SECTION A - ACACIA TREE

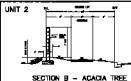

SECTION B - ACACIA TREE

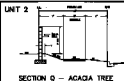

SECTION Q - ACACIA TREE

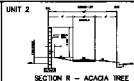

SECTION R - ACACIA TREE

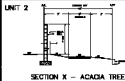

SECTION X - ACACIA TREE

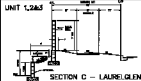

SECTION C - LAURELGLEN

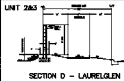

SECTION D - LAURELGLEN

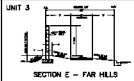

SECTION E - FAR HILLS

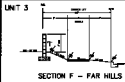

SECTION F - FAR HILLS

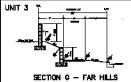

SECTION G - FAR HILLS

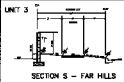

SECTION S - FAR HILLS

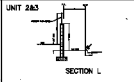

SECTION L

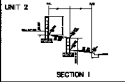

SECTION I

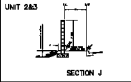

SECTION J

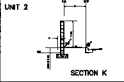

SECTION K

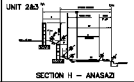

SECTION H - ANASAZI

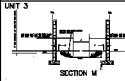

SECTION M

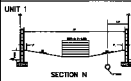

SECTION N

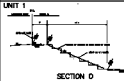

SECTION O

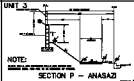

SECTION P - ANASAZI

	ALPHA OMEGA ENGINEERING, INC. 1000 S. 10th Street Phoenix, Arizona 85006
	ROYAL WOODS - UNIT 1 DETAIL SHEET PRESLEY HOMES
DATE: _____ DRAWN BY: _____ CHECKED BY: _____ IN CHARGE: _____	DI 1077-4538-1