

EXISTING PHASE 1, SHOWN FOR REFERENCE ONLY.

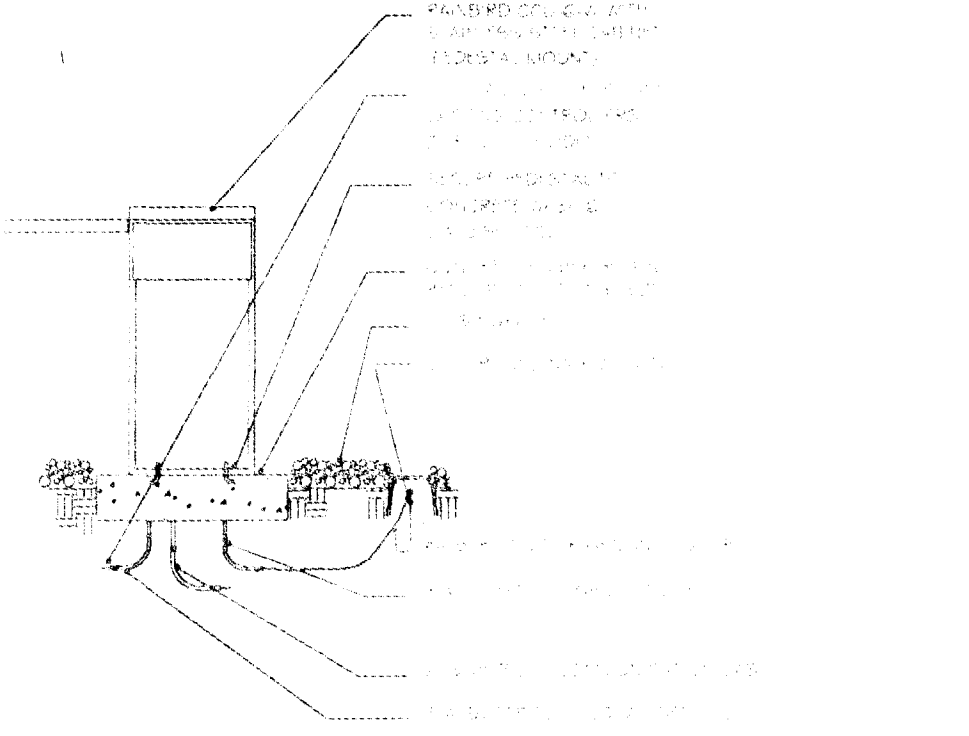

A CLUSTER CONTROL UNIT

EXISTING PHASE 1, SHOWN FOR REFERENCE ONLY.

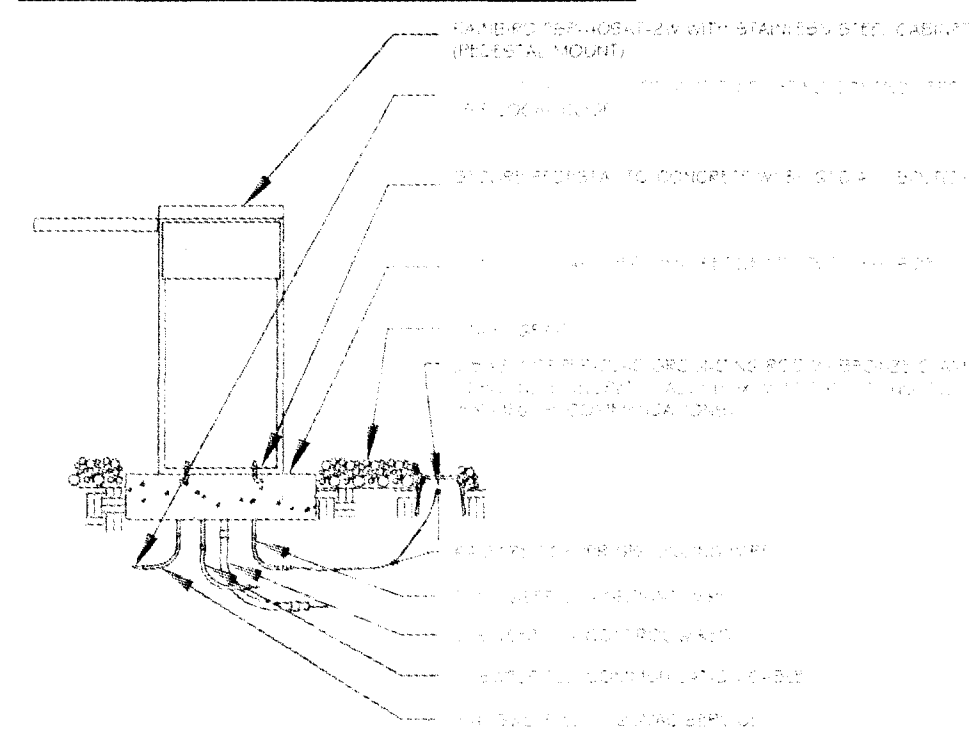

B FIELD SATELLITE CONTROLLER

EXISTING PHASE 1, SHOWN FOR REFERENCE ONLY.

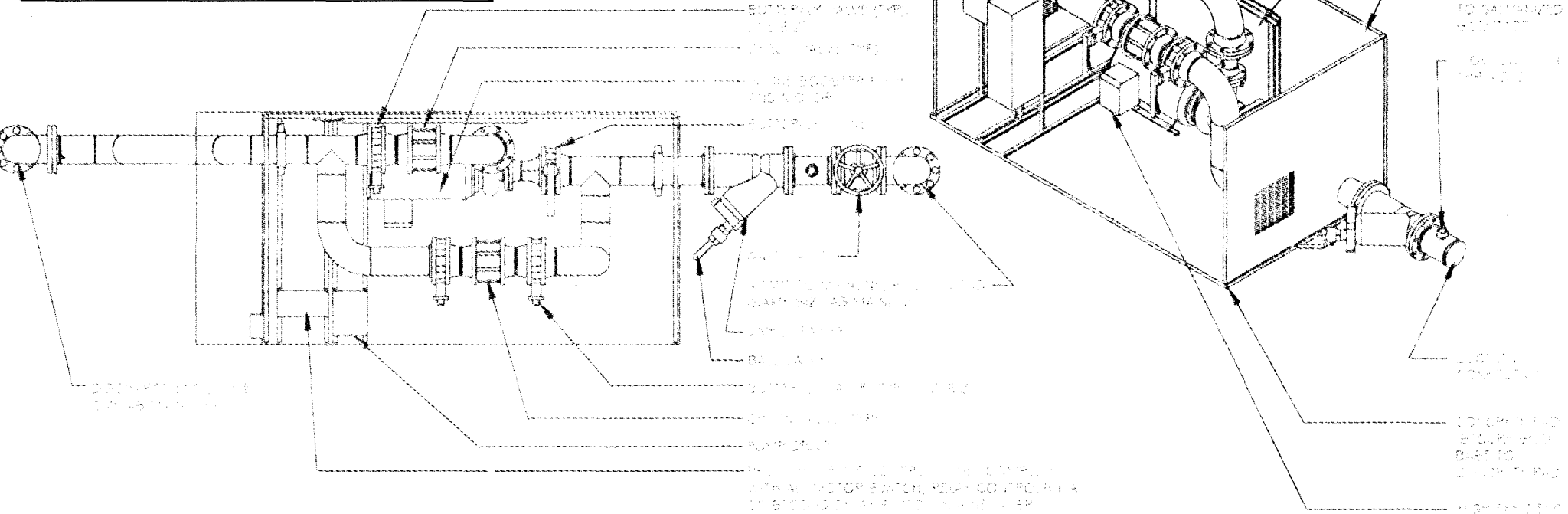

C BOOSTER PUMP STATION DETAIL

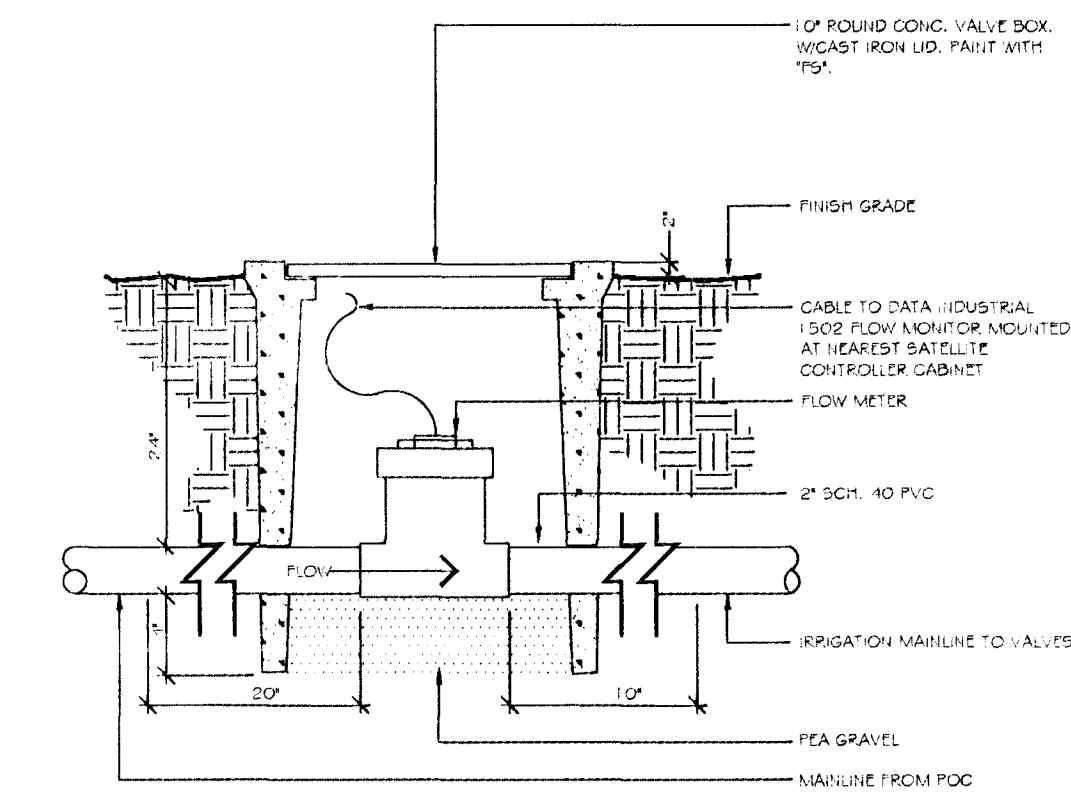

D FLOW METER/SENSOR DETAIL

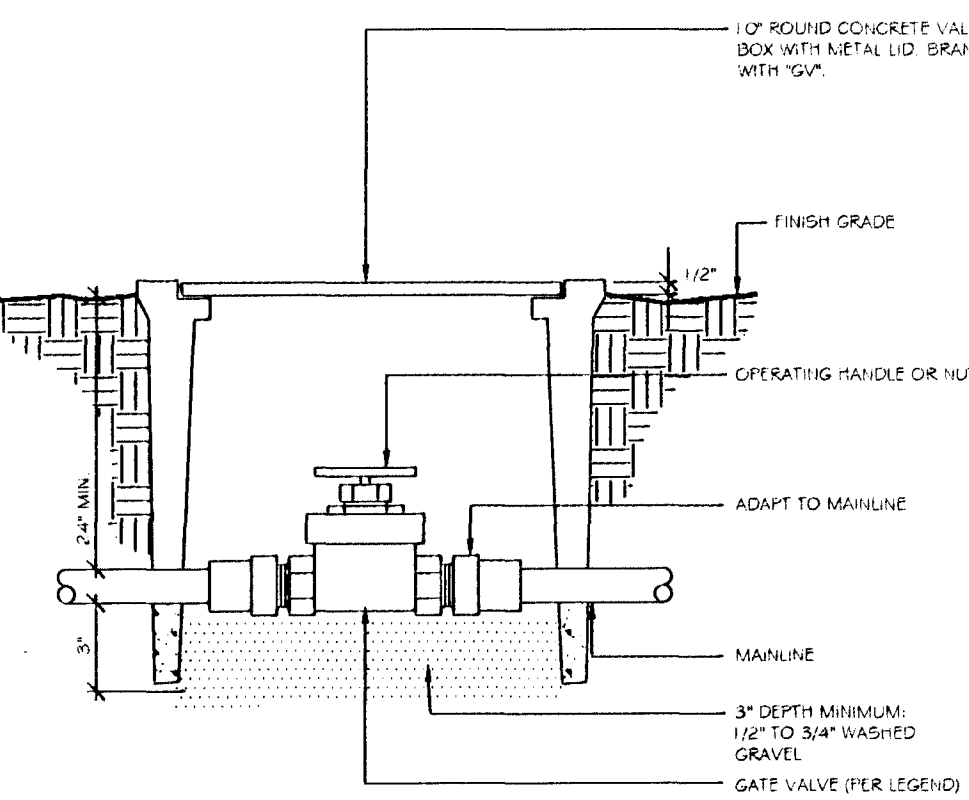

E GATE VALVE

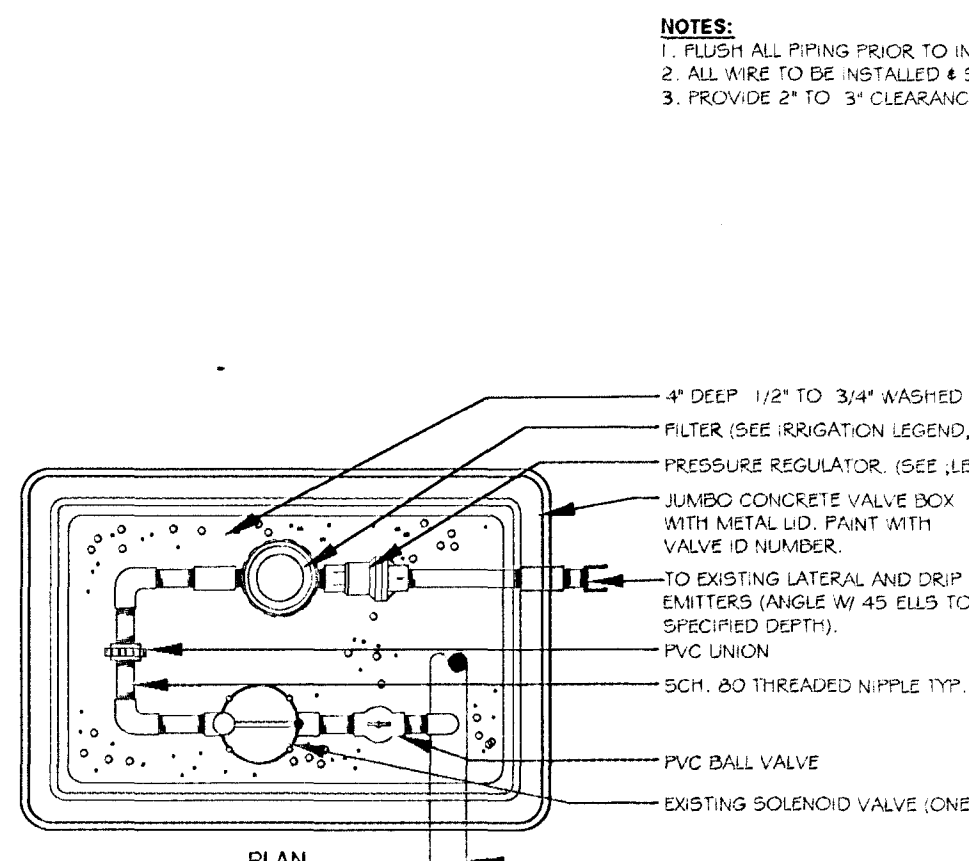

F DRIP VALVE ASSEMBLY

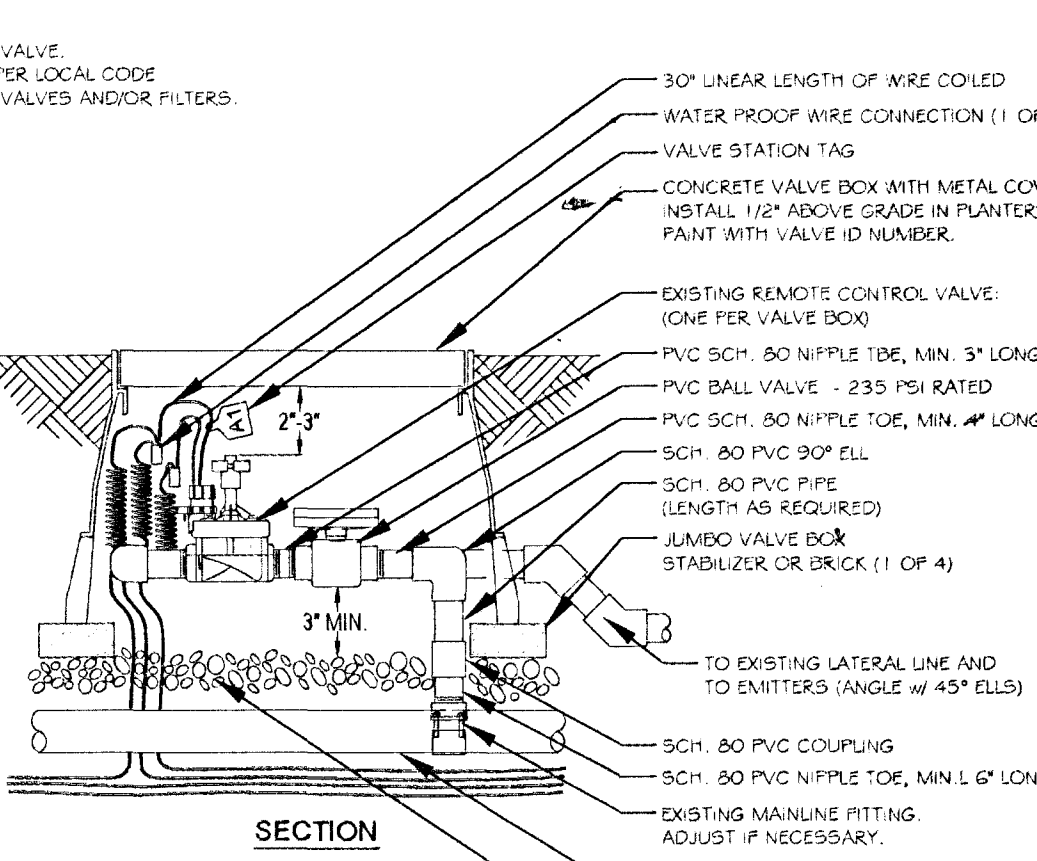

G CONTROL VALVE

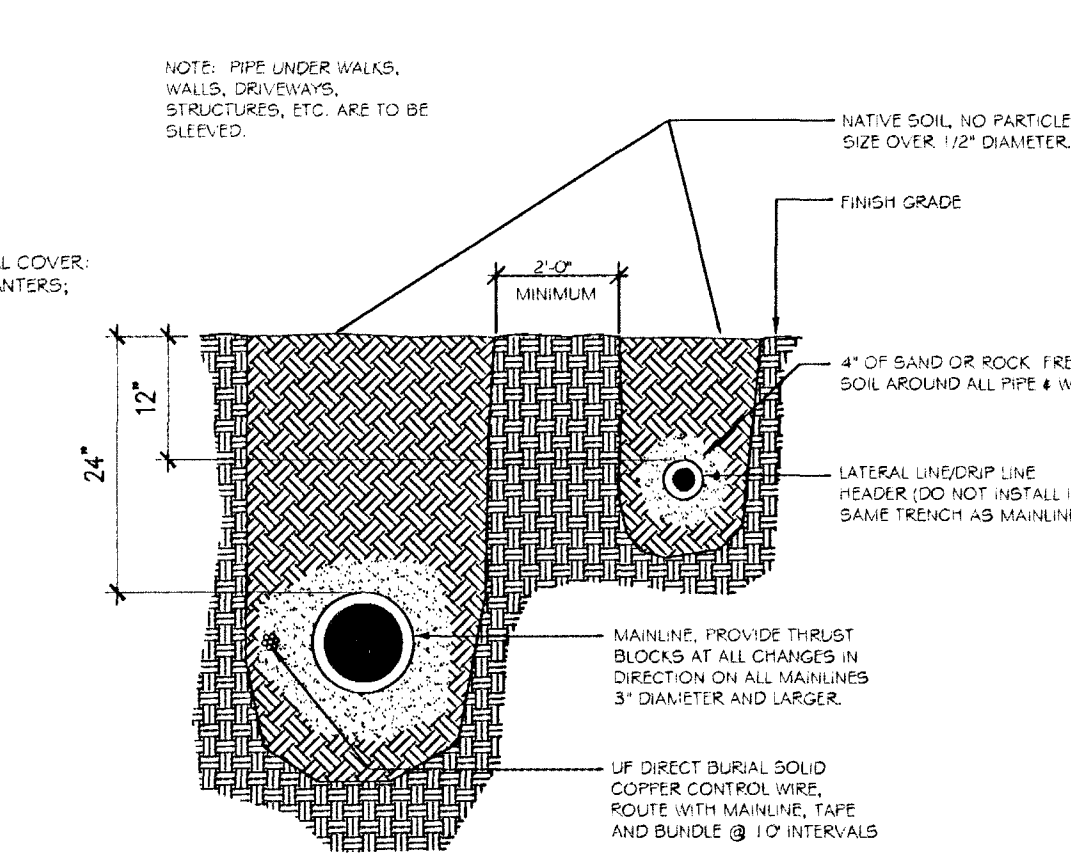

H TRENCH SECTION

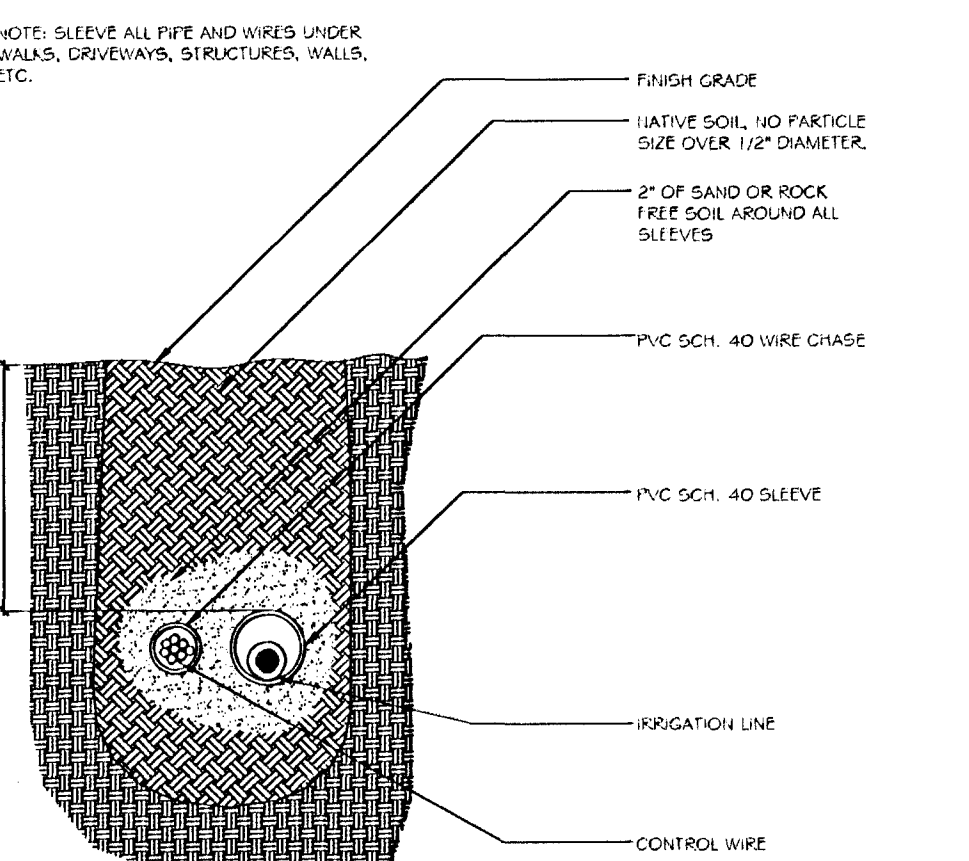

I SLEEVE SECTION

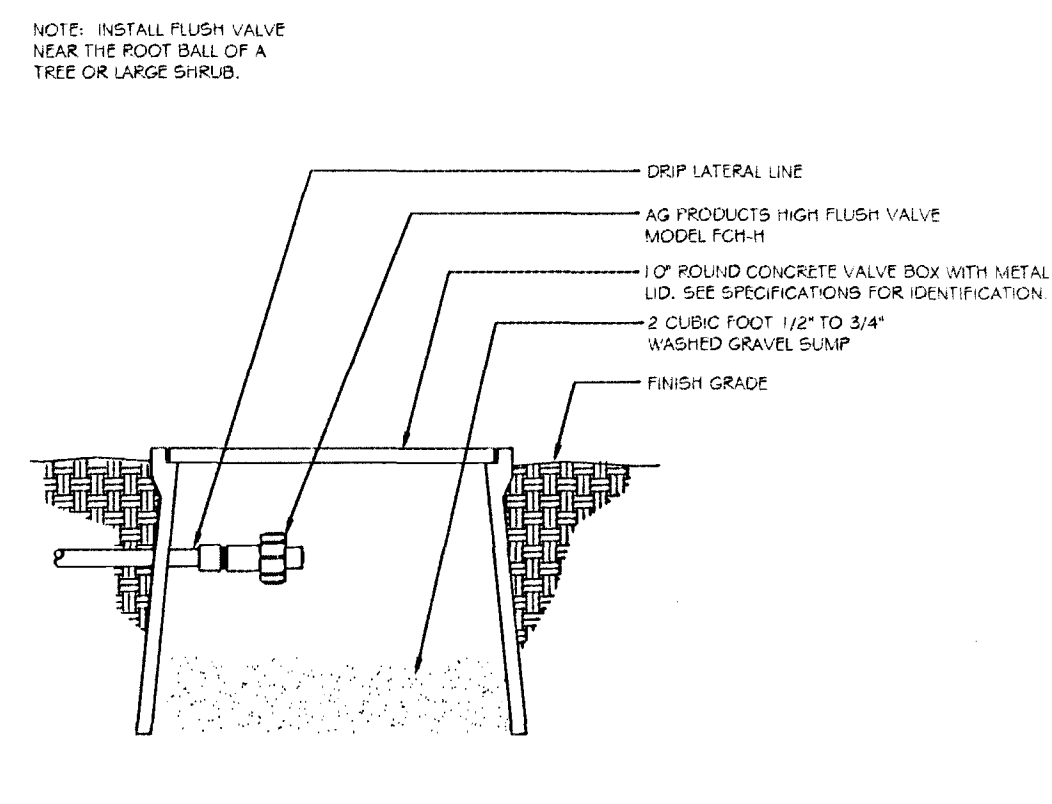

J END FLUSH VALVE

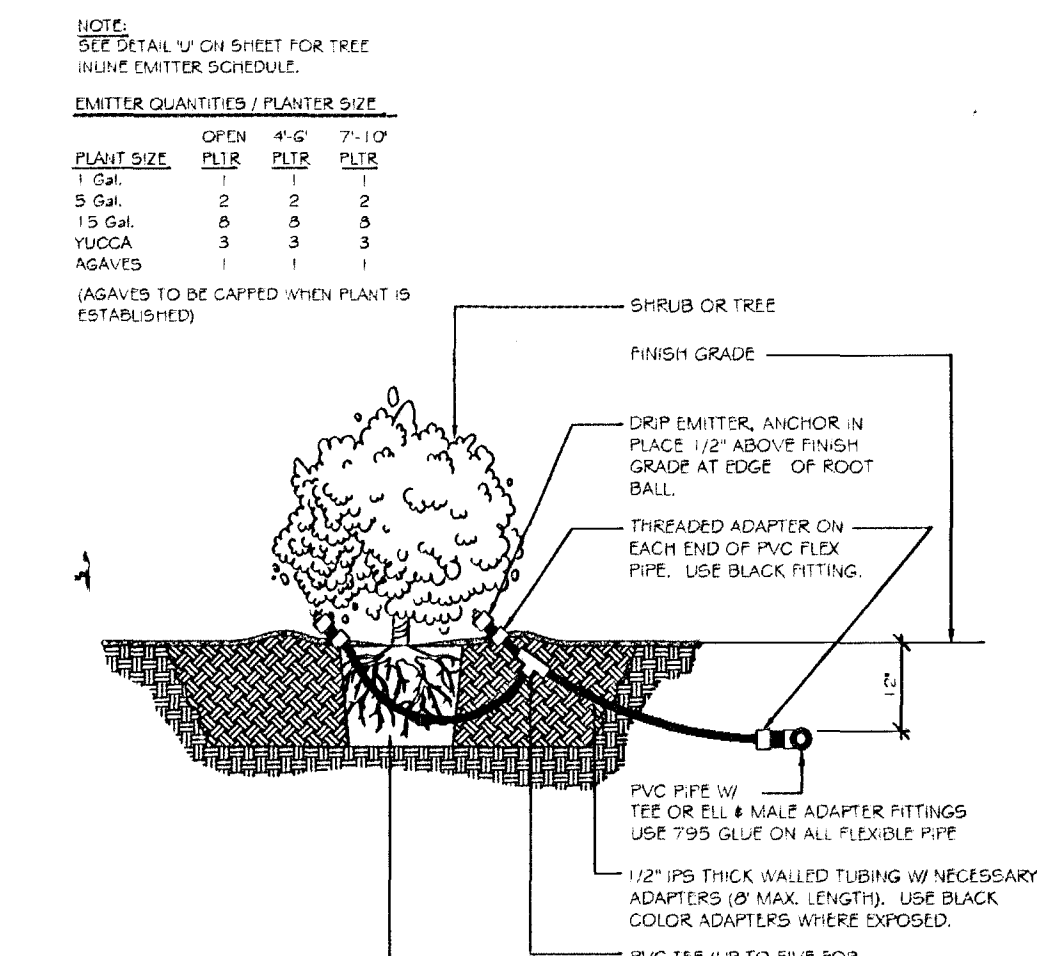

K SHRUB DRIP EMITTER

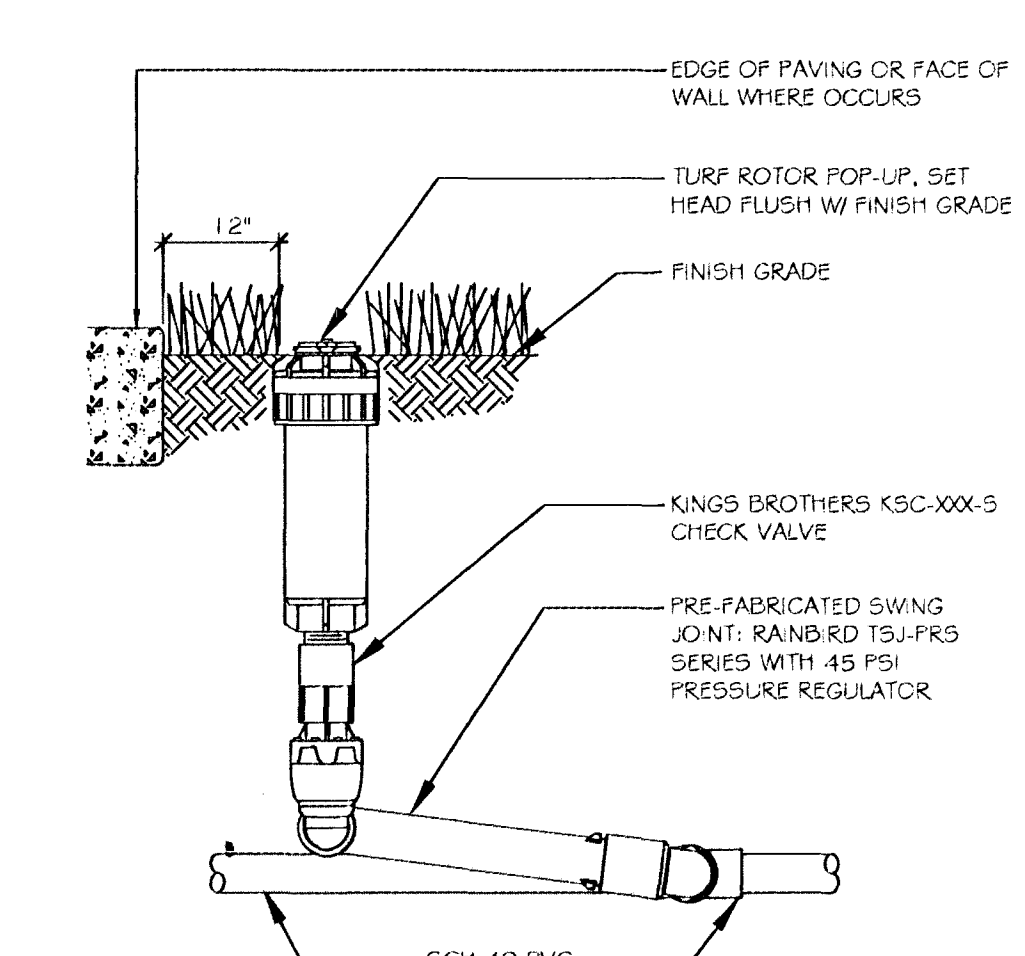

L TURF ROTOR HEAD

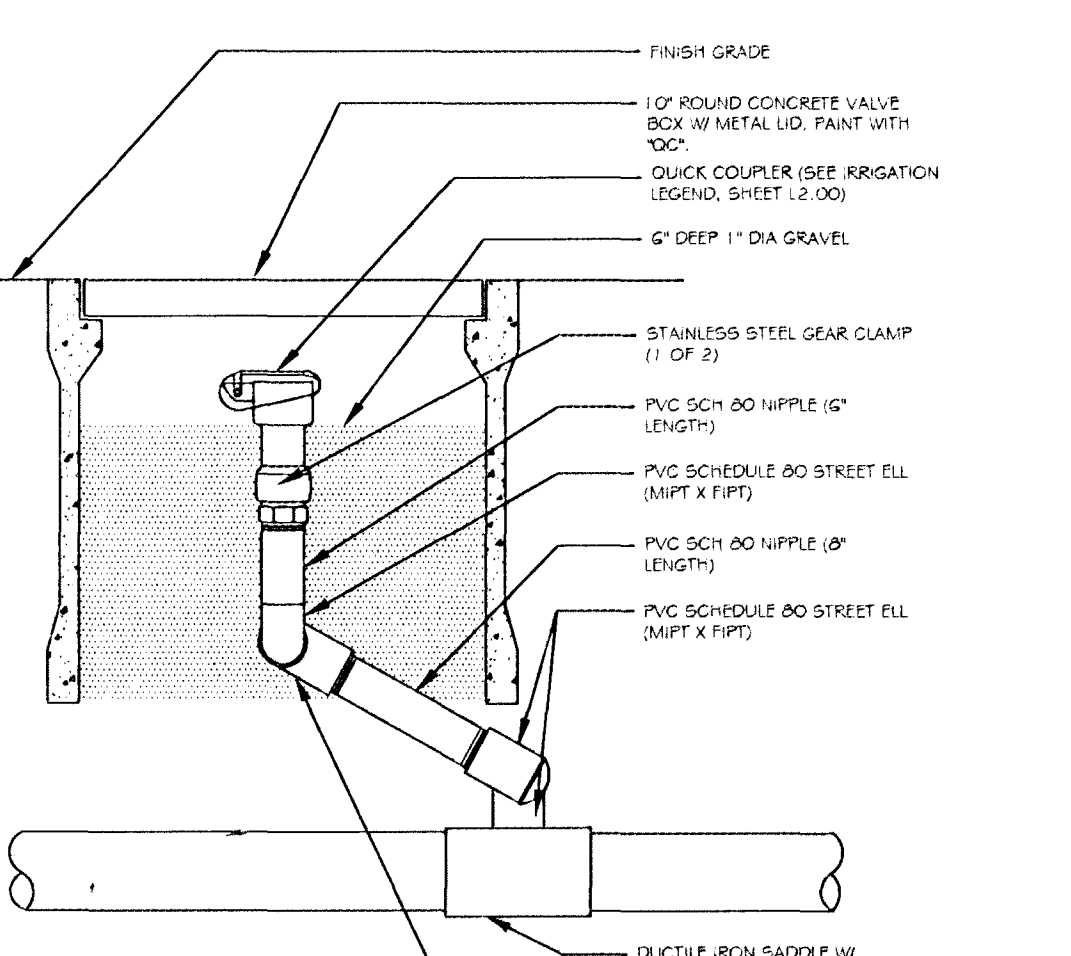

M QUICK COUPLER VALVE

NOTE: SEE DETAIL V ON SHEET FOR TREE IRRIGATION EMITTER SCHEDULE.

EMITTER QUANTITIES / PLANTER SIZE	1' DIA	1 1/2' DIA	2' DIA
1' DIA	2	2	2
1 1/2' DIA	2	2	2
2' DIA	2	2	2
AGAVES	1	1	1

(AGAVES TO BE CAPPED WHEN PLANT IS ESTABLISHED)



REVISIONS

CONSULTANT

southwick
LANDSCAPE ARCHITECTS

12 Commerce Center Drive
Hempstead NY 11547

CITY OF LAS VEGAS
TROPICAL DURANGO PARK - PHASE II
6015 N. DURANGO DRIVE

IRRIGATION DETAILS

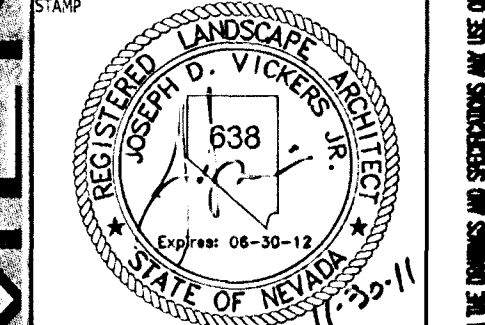

OWNER: CITY OF LAS VEGAS
DEPARTMENT OF PUBLIC WORKS

333 NORTH RANCHO DRIVE
LAS VEGAS, NEVADA 89101
PHONE: (702) 229-6535
FAX: (702) 384-4846
TDD: (702) 386-9101

DRAWN: SLA
FILE: 10-034
DATE: 11/09/11
SCALE: AS SHOWN
PID NO: 1015341.06
CLV DRG NO: 650.103-2
HATCH NO: 38998
SHT NO: L2.04
28 OF 37

683