

PLASTER DEVELOPMENT
CITY OF LAS VEGAS

vtm nevada

CONSULTING ENGINEERS - PLANNERS
2300 PASEO DEL PRADO, BUILDING A, SUITE 100
LAS VEGAS, NEVADA 89102 PHONE (702) 873-7550

REV	DATE	BY	REVISION
1	02/26/84	SCD	SEWER MVS PEE FIELD

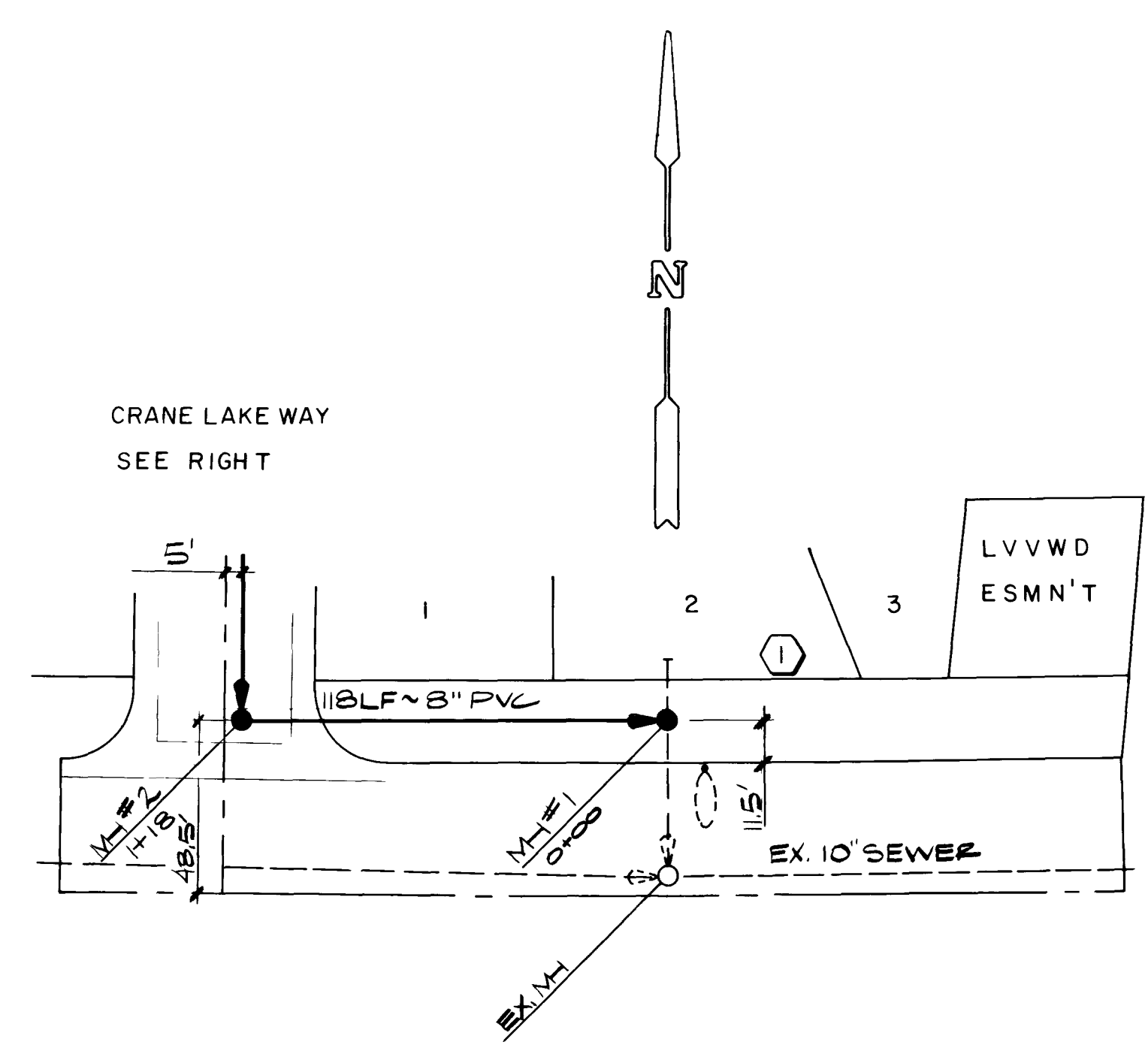

LAKE NORTH DRIVE

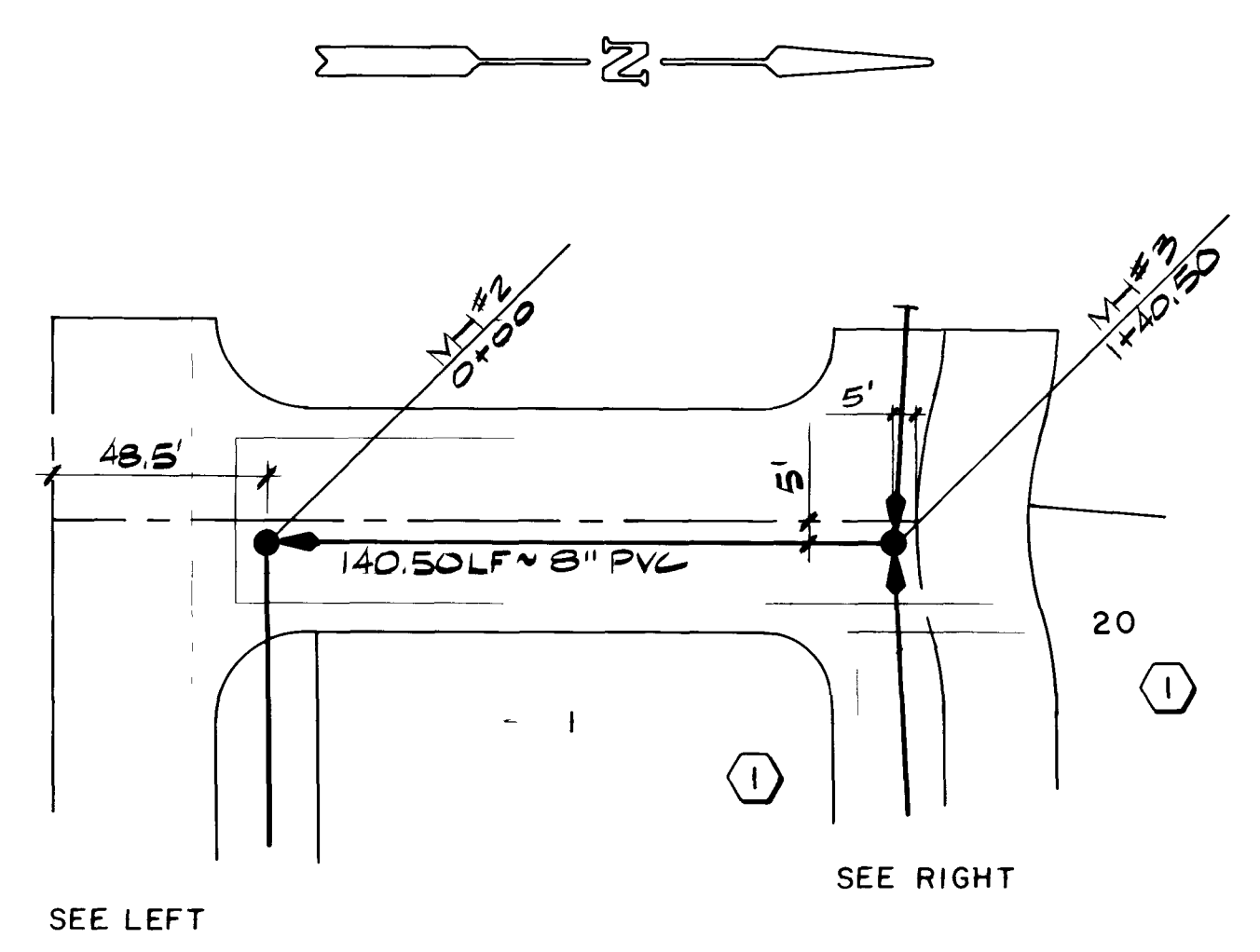

CRANE LAKE WAY

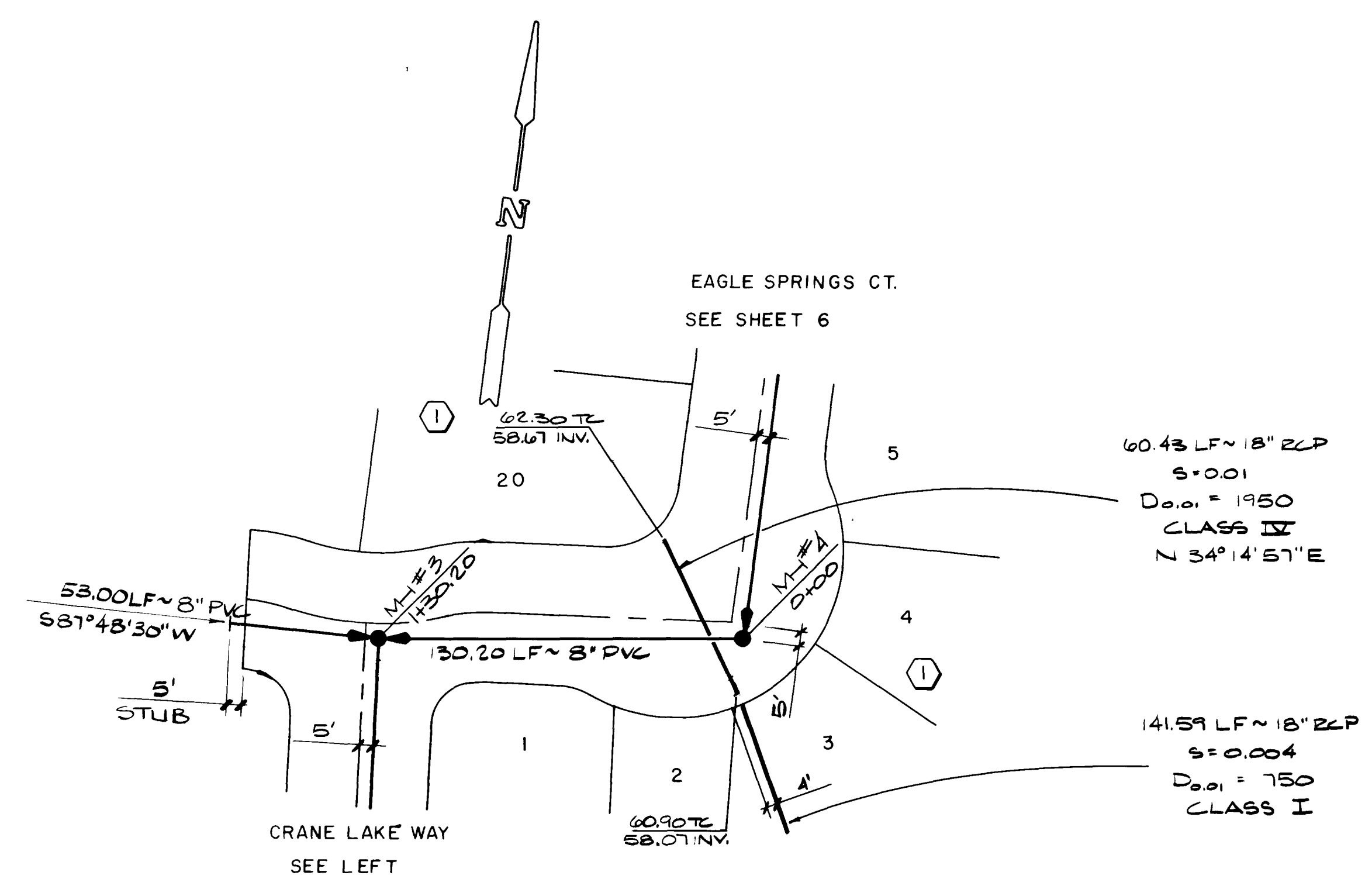

SANDY SHORES DRIVE

TITLE
SEWER PLAN & PROFILE
LAKE NORTH DR., CRANE LAKE WAY & SANDY SHORES DR.

PROJECT
STYLE AT THE LAKES
UNIT 1

NO. NO.	3407
BY	SCD
DATE	
SCALE	1" = 40' 1" = 4'

SHEET	5
OF 6 SHEETS	

R. Q. Anton
C.L.V. SANITATION SUPERVISOR DATE 10-29-84

5258 19 8-17 307Y-2831-1

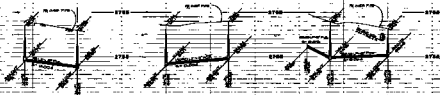

PROJECT: **SEWER LINES**
 SHEET NO.: **10**
 DATE: **10/1/58**
 DRAWN BY: **J. J. [unclear]**
 CHECKED BY: **[unclear]**
 APPROVED BY: **[unclear]**
 CITY OF LAKEWOOD
 DEPARTMENT OF PUBLIC WORKS
 1000 WEST 10TH STREET
 LAKEWOOD, COLORADO 80027
 PHONE: 438-1111

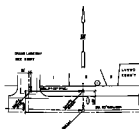

LAKE NORTH DRIVE

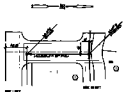

CRANE LAKE WAY

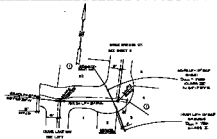

SANDY SHORES DRIVE

SEWER PLAN & PROFILE
LAKE NORTH DRIVE, CRANE LAKE WAY & SANDY SHORES DRIVE AT THE LAKES
 SHEET 10

DATE	10/1/58
BY	J. J. [unclear]
CHECKED BY	[unclear]

SCALE: **AS SHOWN**
 CITY OF LAKEWOOD

J. J. [unclear]
 LICENSE NO. 10111