

SECTION A
NO SCALE

SECTION B
NO SCALE

DATE	
BY	
SCALE	
PLAN	DESIGNED BY: JH
	DRAWN BY: JH
	CHECKED BY: JH
	DATE: 8/19/88
	PROJECT: STREET IMPROVEMENTS
	LOCATION: BRADLEY ROAD - HICKAM AVENUE
	SHEET: 2 OF 3

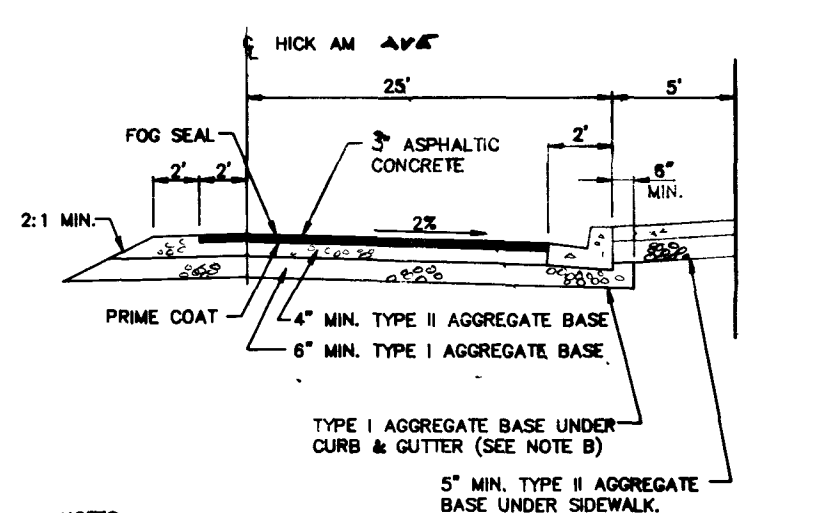
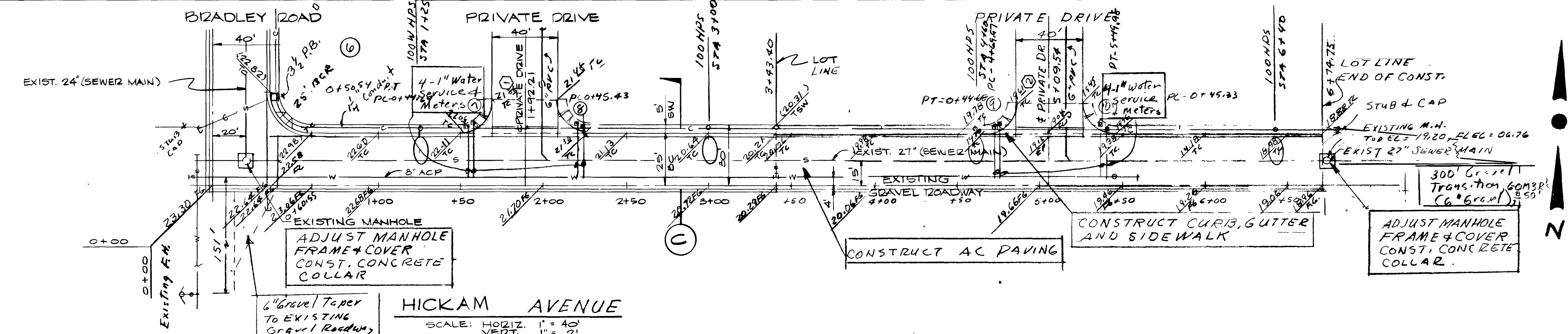
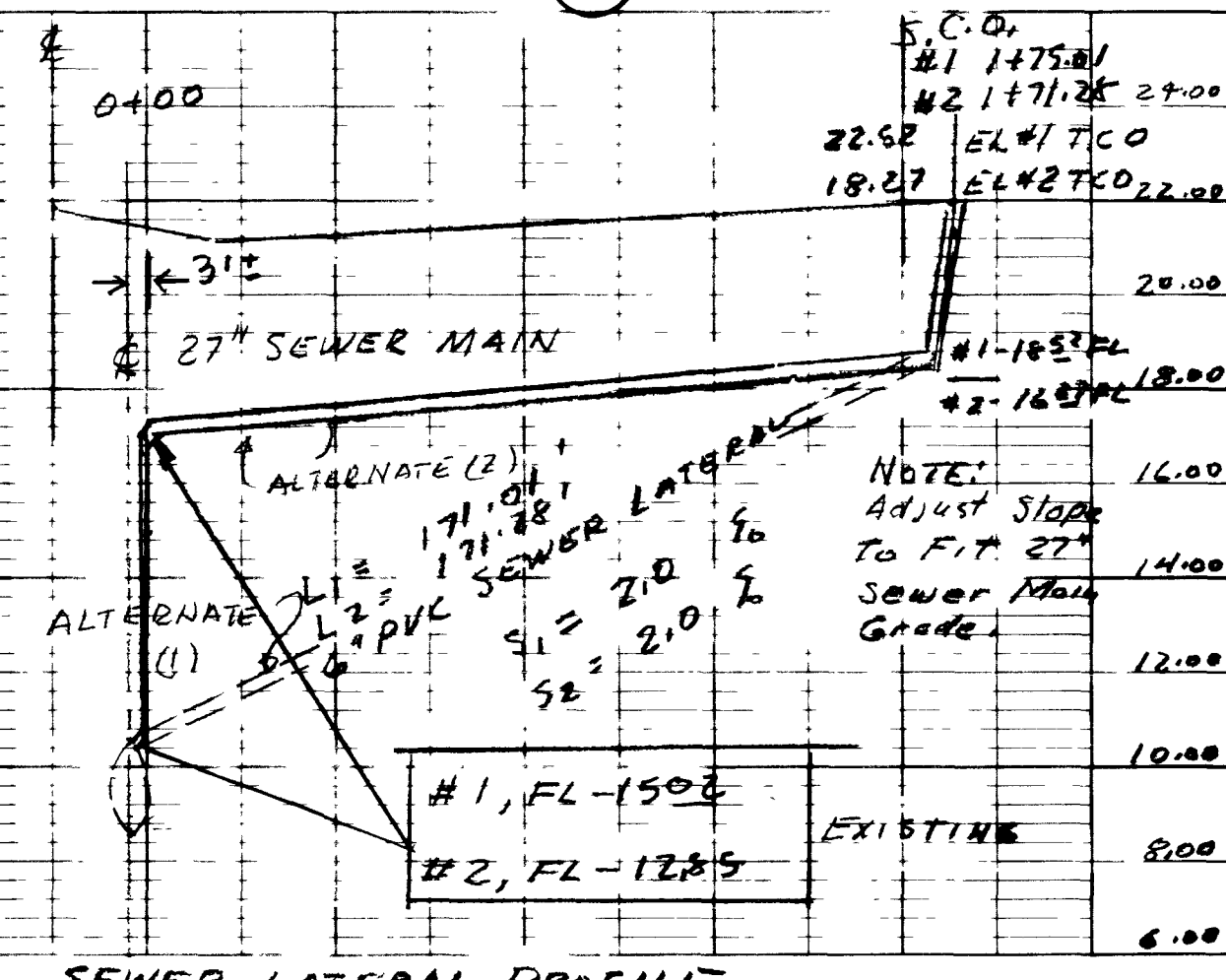
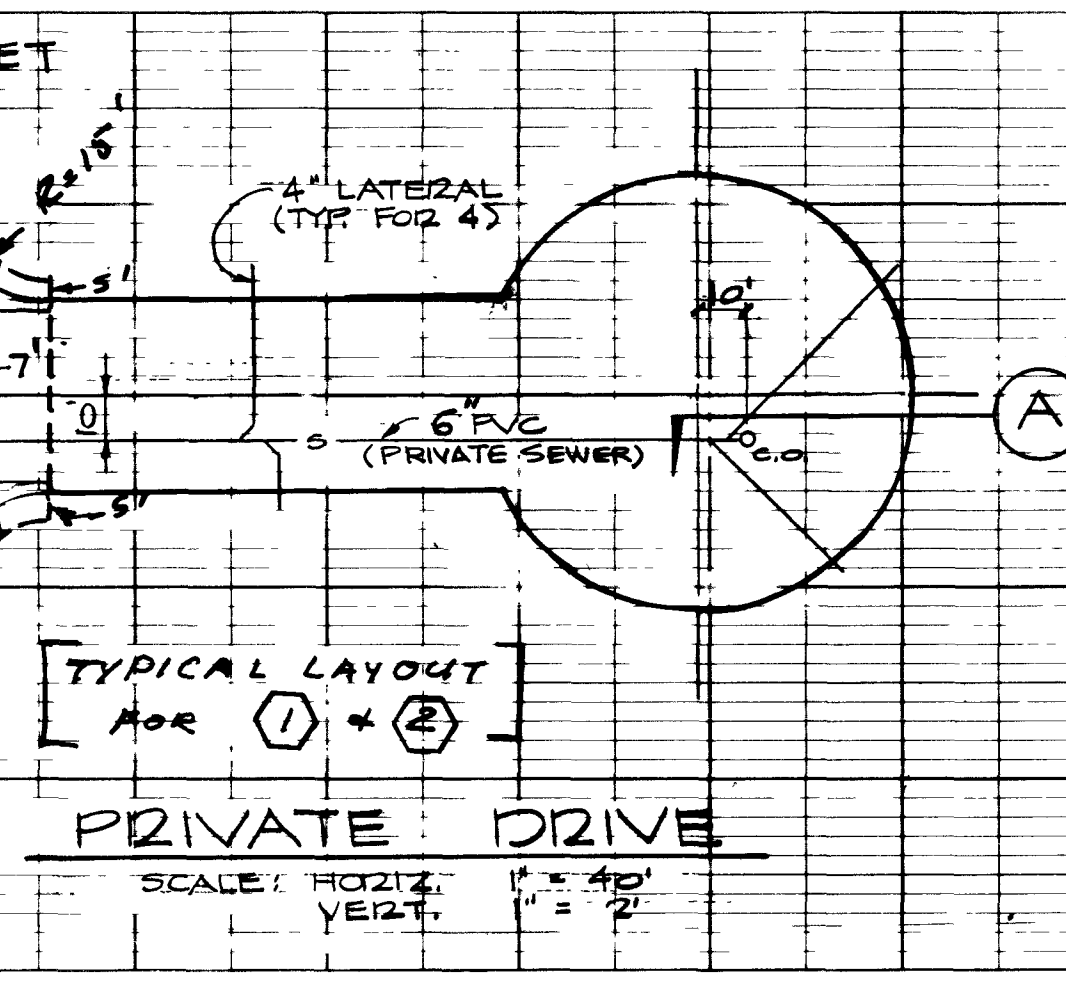
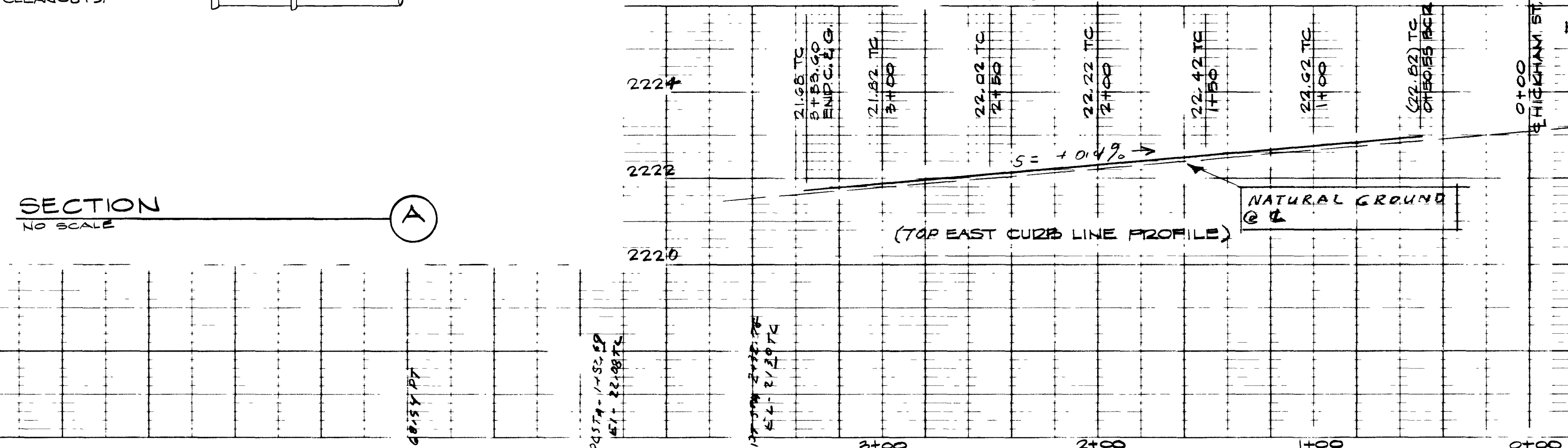

SECTION C
NO SCALE

DATE	
BY	
SCALE	
PROFILE	DESIGNED BY: JH
	DRAWN BY: JH
	CHECKED BY: JH
	DATE: 8/19/88
	PROJECT: STREET IMPROVEMENTS
	LOCATION: BRADLEY ROAD - HICKAM AVENUE
	SHEET: 2 OF 3

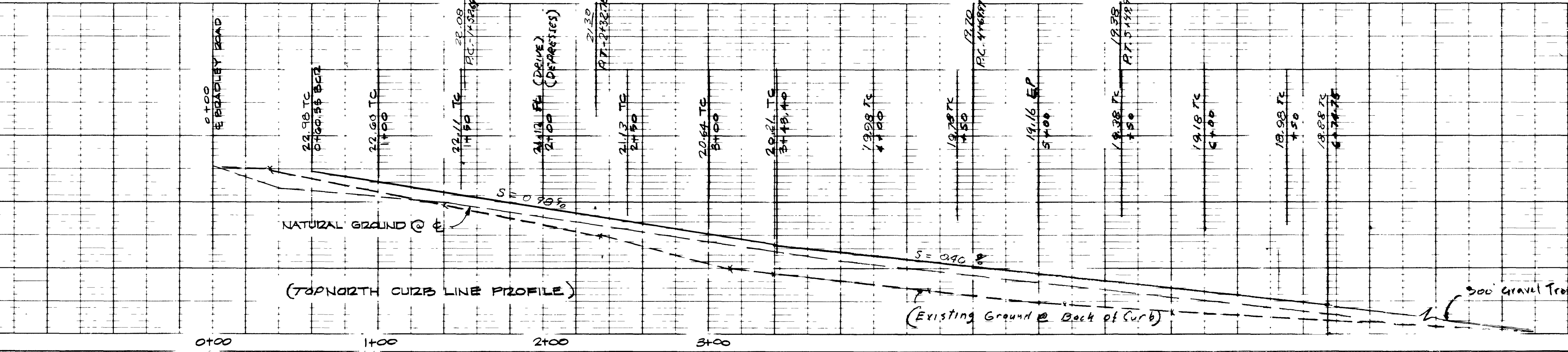

Corr: 8/19/88 MML Per Marked Prints

SILVER STATE DEVELOPMENT CO.
LAS VEGAS, NEVADA
PLAN & PROFILE
STREET IMPROVEMENTS
BRADLEY ROAD - HICKAM AVENUE

CHAMPION ENGINEERING COMPANY
145 W. SUNSET ROAD #20
HENDERSON, NEVADA 89015
P.O. BOX 20925
LAS VEGAS, NEVADA 89126 (702) 777-1938

SCALE: DESIGNED HC, DRAWN JH, SECTION JH

JOB NO.: HC880182
SHEET 2 OF 3
107-V1582

7.3.34

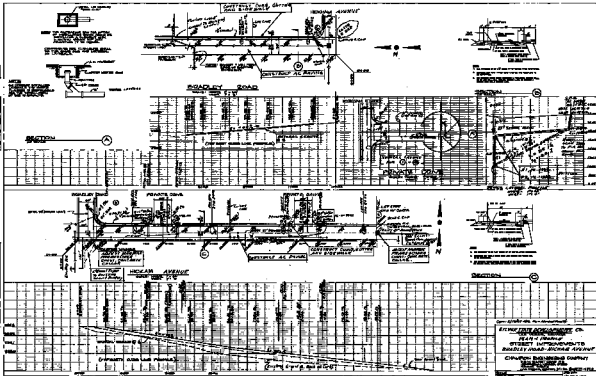

SHEET NO. 101
 OF 102

SHEET NO. 102
 OF 102

ENGINEERING AGREEMENT OF
 ROADWAY IMPROVEMENTS
 BRADLEY ROAD-HICKAM AVENUE
 CHICAGO ENGINEERING COMPANY
 CHICAGO, ILL.
 DRAWN BY: [Name]
 CHECKED BY: [Name]
 DATE: [Date]