

1 TYP SECTION FOR 51' R/W
STD CROWN 0.42'
CANYON DRIVE, LANTERN LANE, JUSTICE LANE
STONEWOOD COURT, CAMEO CIRCLE, ROSEMARY LANE

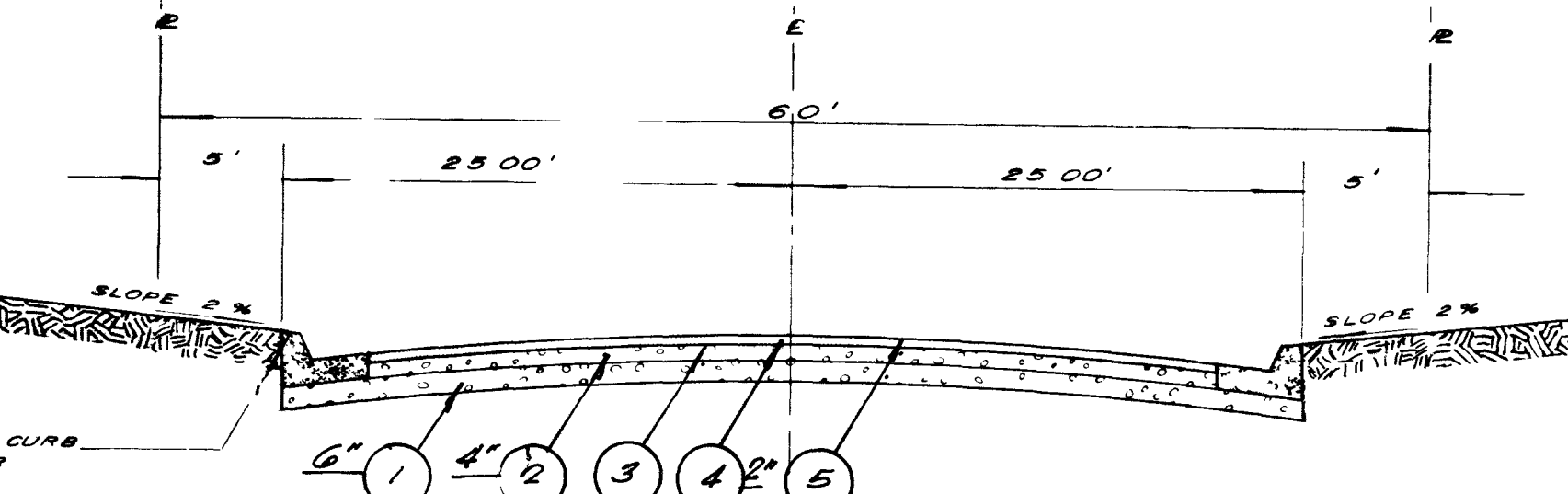

2 TYP SECTION FOR 60' R/W
STD CROWN 0.48'
CAMPBELL DRIVE, LANTERN LANE (EAST)

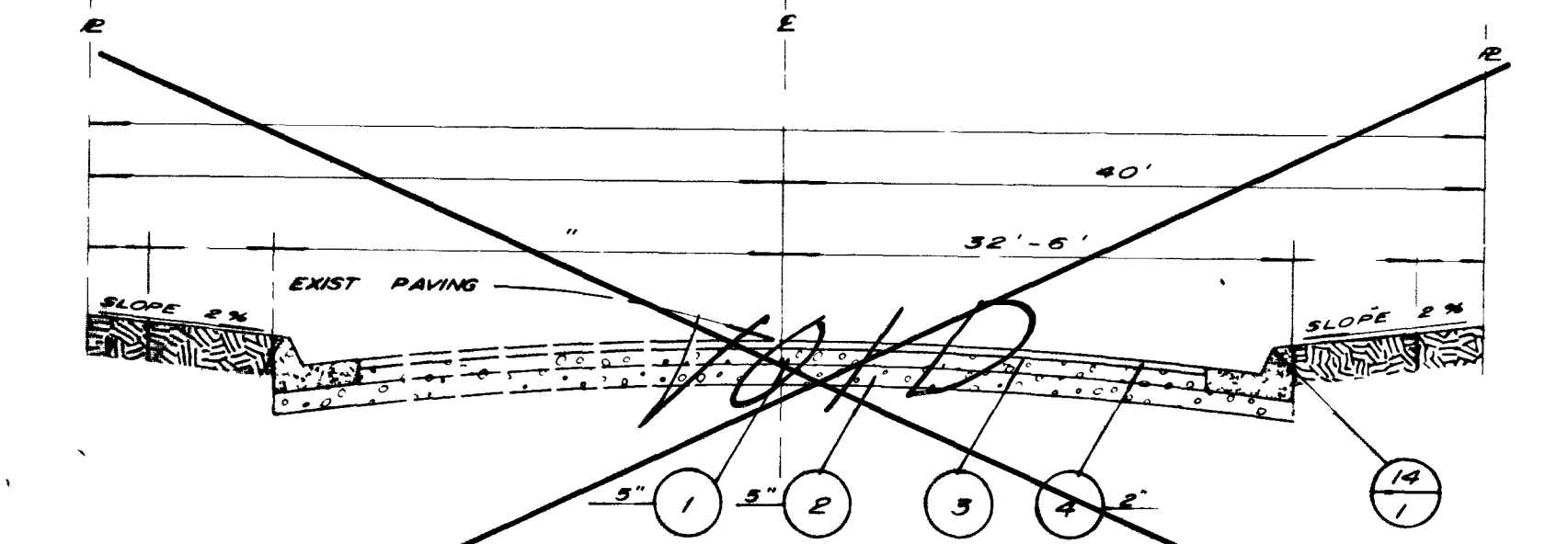

3 TYP SECTION FOR ALTA DRIVE
STD CROWN 0.60'

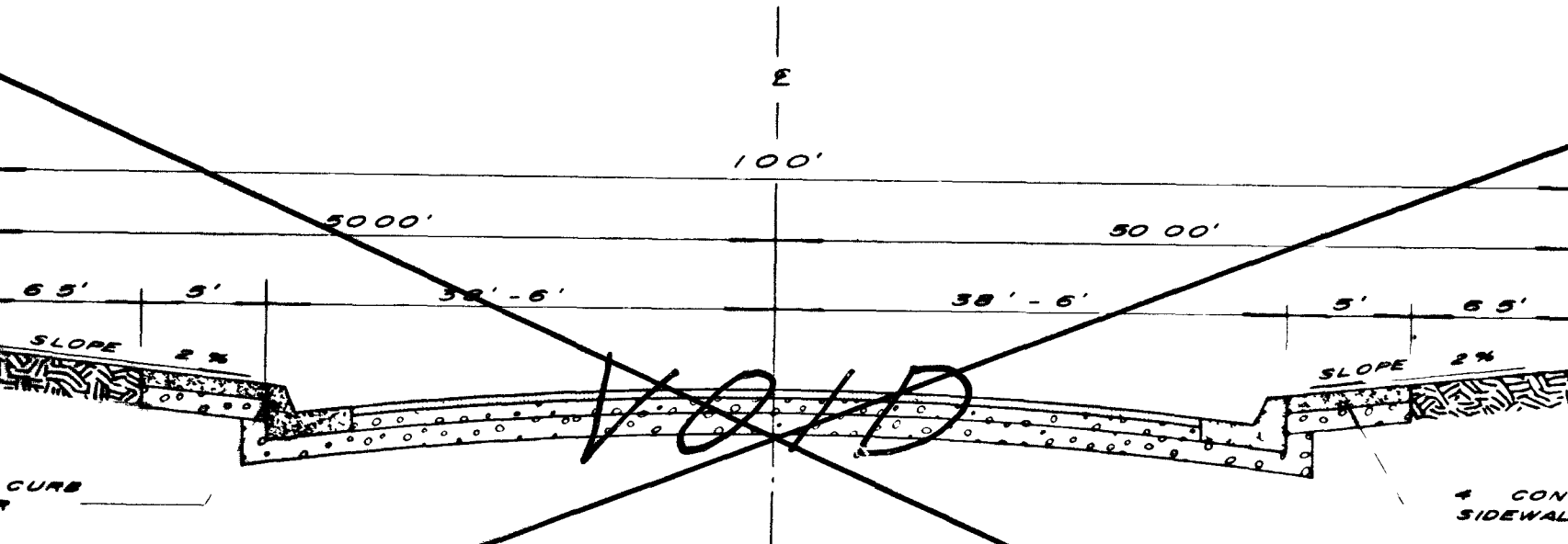

4 TYP SECTION FOR 100' R/W
STD CROWN 0.70'

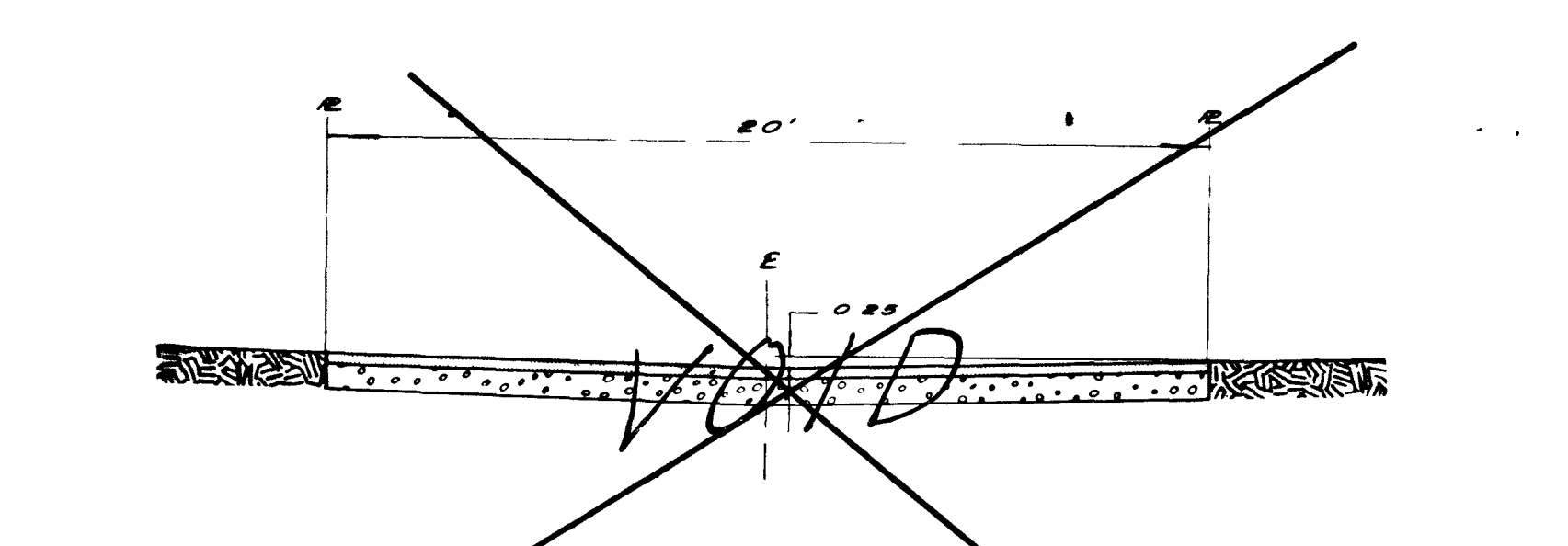

5 TYP ALLEY SECTION
INVERTED CROWN 0.25'

- LEGEND**
- 1 TYPE I GRAVEL BASE
 - 2 TYPE II GRAVEL BASE
 - 3 BITUMINOUS PRIME COAT
 - 4 BITUMINOUS ASPHALTIC CONCRETE
 - 5 BITUMINOUS FOG SEAL COAT
 - 6 BITUMINOUS SEAL COAT & CHIPS
 - 7 SECTION OR DETAIL NUMBER
 - 8 SHEET NUMBER OF SHEET ON WHICH DETAIL IS SHOWN

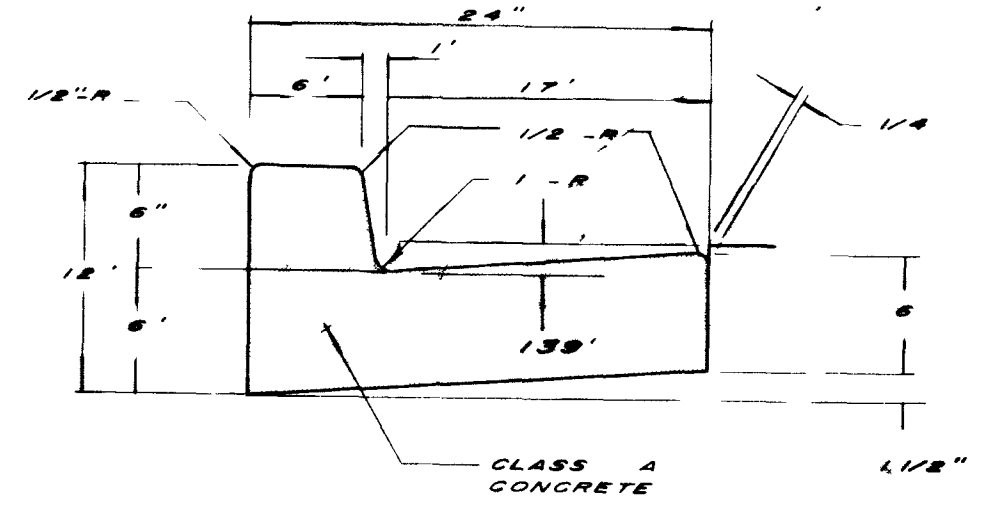

6 "L" TYPE CURB AND GUTTER

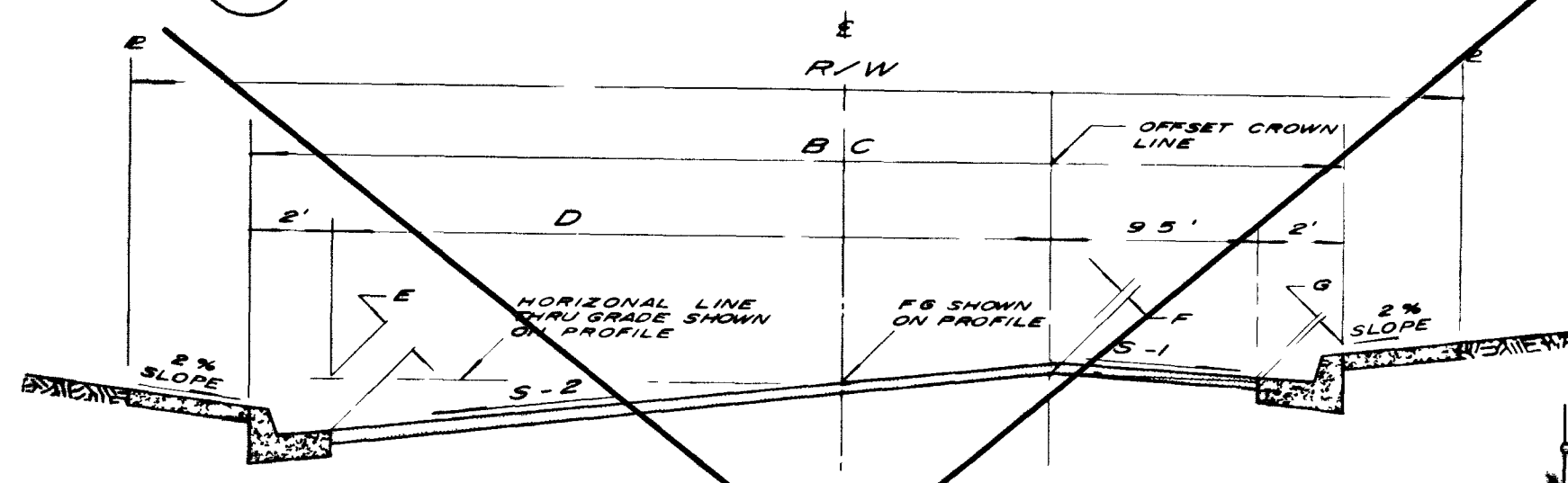

0.40' CROSSFALL

| R/W | BC | D | E | F | G | S-1 | S-2 | CROWN TO LOW FL | CROWN TO HIGH FL |
|-----|-----|-------|--------|--------|--------|----------|----------|-----------------|------------------|
| 31' | 4' | 27.5' | 0.365' | 0.17' | 0.035' | 0.0154FT | 0.0154FT | 0.681' | 0.281' |
| 40' | 20' | 38.5' | 0.348' | 0.200' | 0.038' | 0.0154FT | 0.0154FT | 0.681' | 0.281' |
| 60' | 65' | 51.5' | 0.332' | 0.221' | 0.079' | 0.0154FT | 0.0154FT | 0.681' | 0.281' |

0.60' CROSSFALL

| R/W | BC | D | E | F | G | S-1 | S-2 | CROWN TO LOW FL | CROWN TO HIGH FL |
|-----|-----|------|--------|--------|--------|----------|----------|-----------------|------------------|
| 80' | 65' | 5.5' | 0.321' | 0.303' | 0.161' | 0.0154FT | 0.0154FT | 0.681' | 0.281' |

7 TYP CROSSFALL SECTION FOR R/W

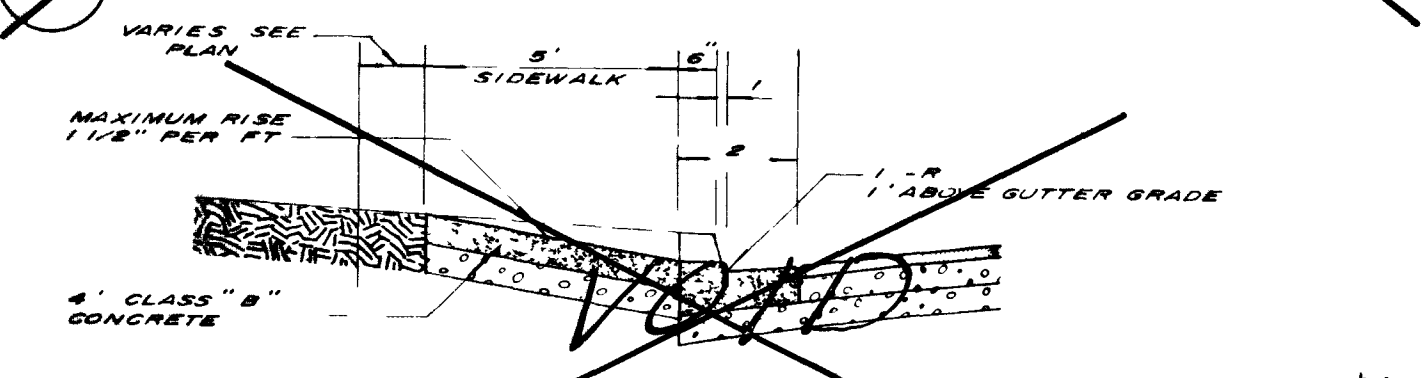

8 ROLL TYPE CURB DETAIL

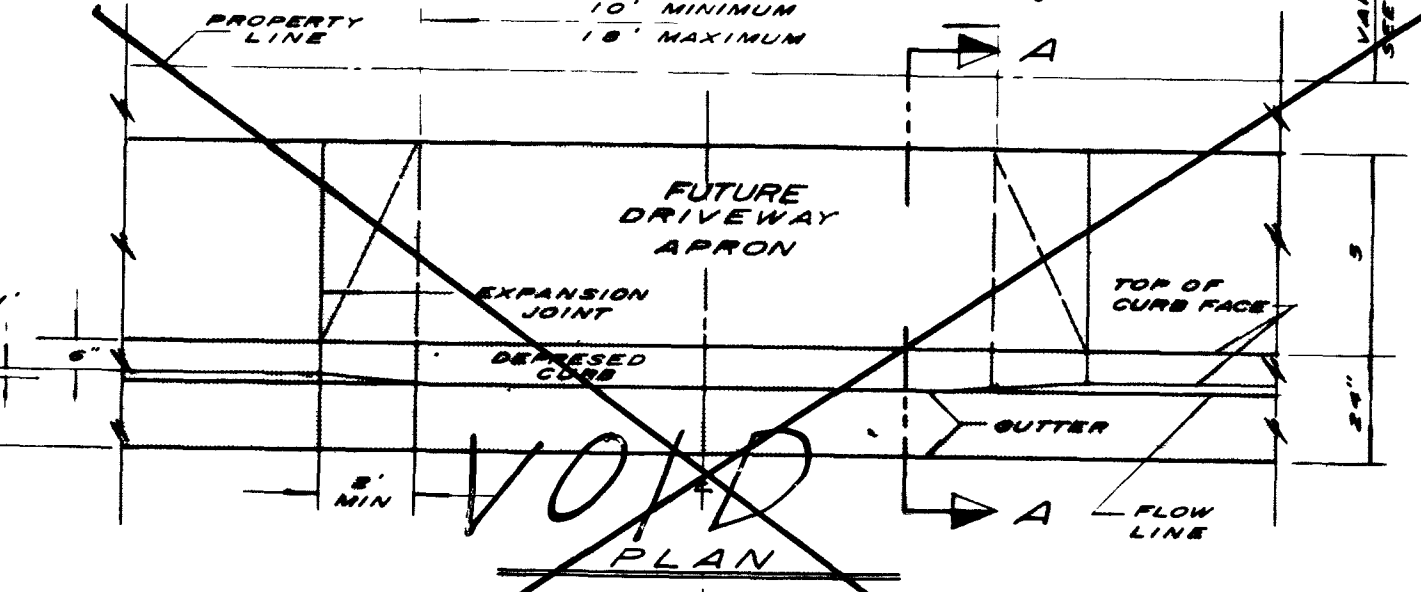

9 SECTION A - A

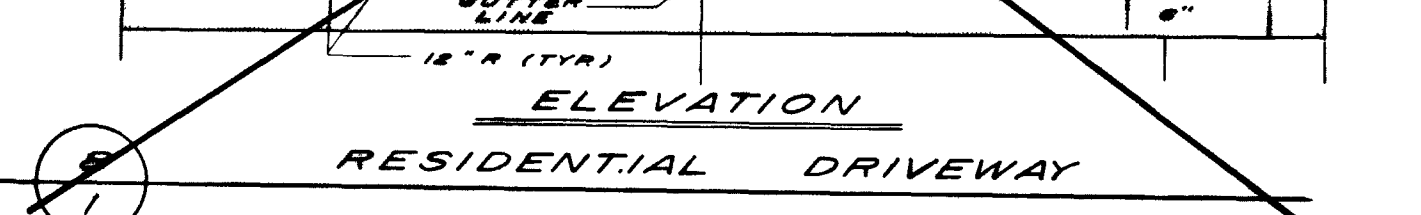

10 ELEVATION RESIDENTIAL DRIVEWAY

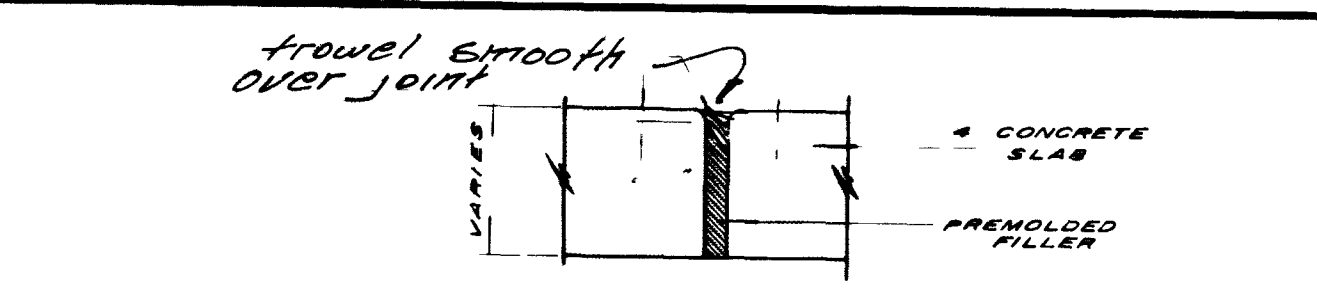

9 EXPANSION JOINT

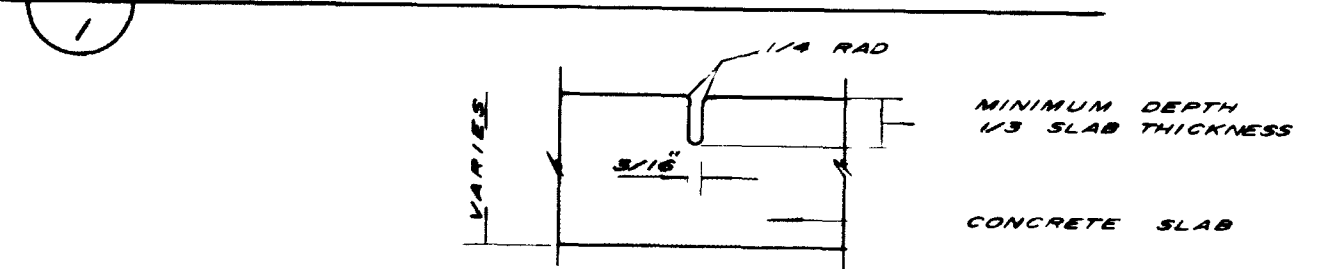

10 WEAKENED PLANE JOINT

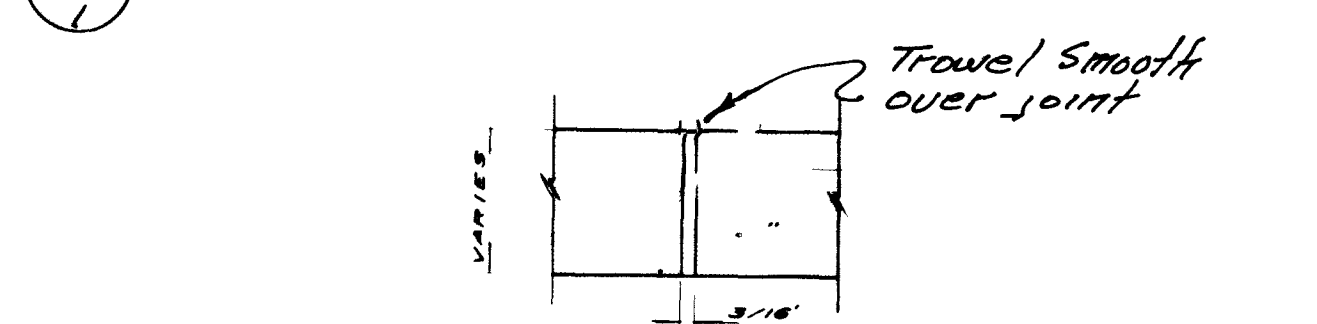

11 FORM PLATE JOINT

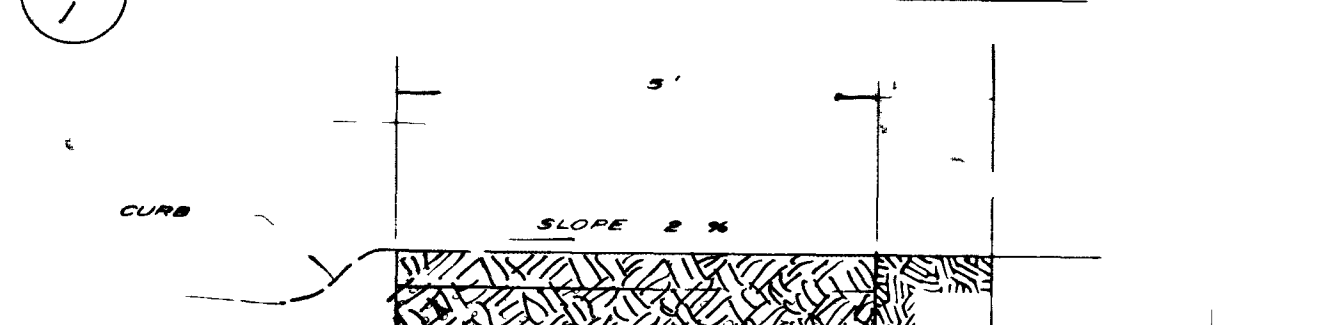

12 SECTION B - B

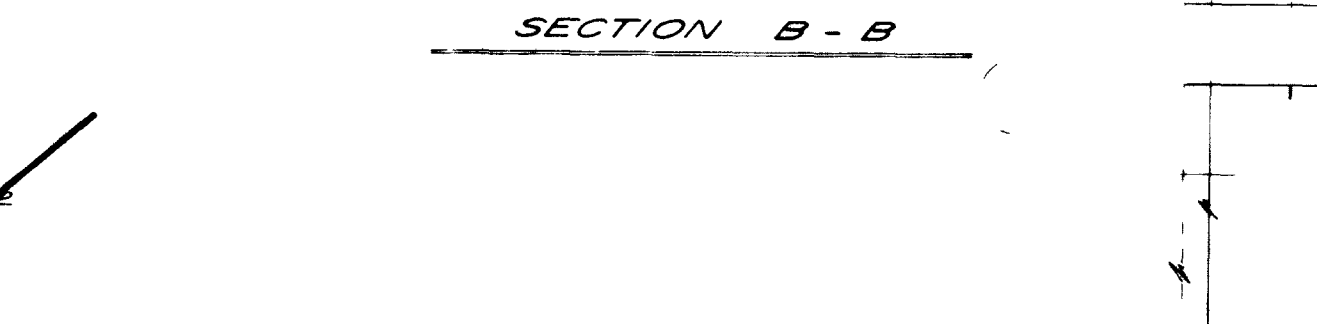

13 VALLEY GUTTER DETAIL



14 CURB RETURN DETAIL

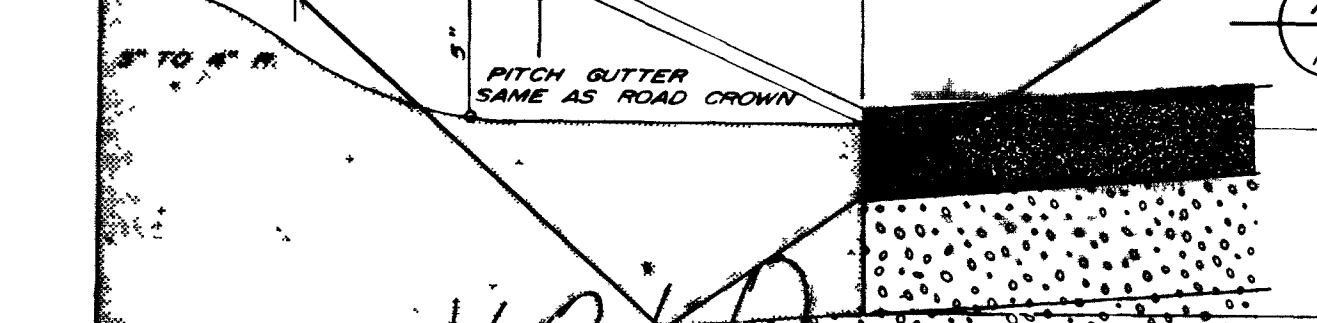

15 CONCRETE SWALE DETAIL

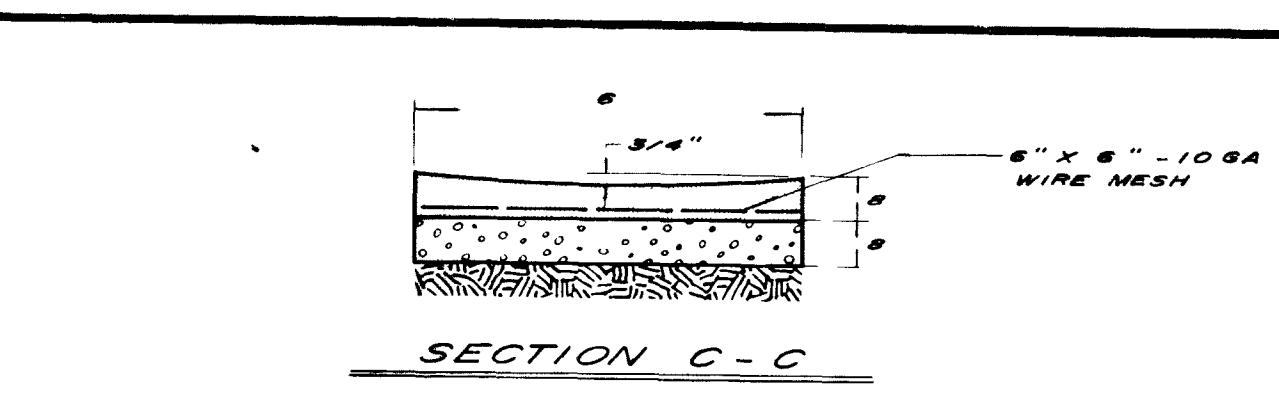

16 SECTION C - C

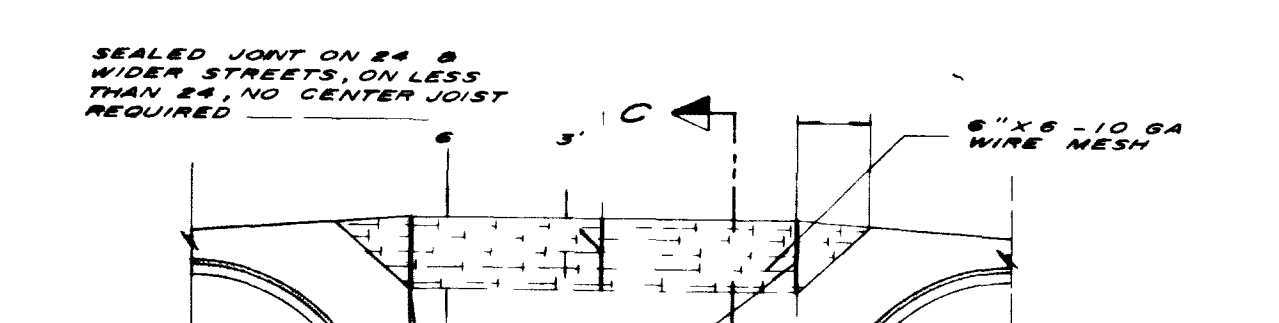

17 SEALED JOINT ON EXP. JOINT

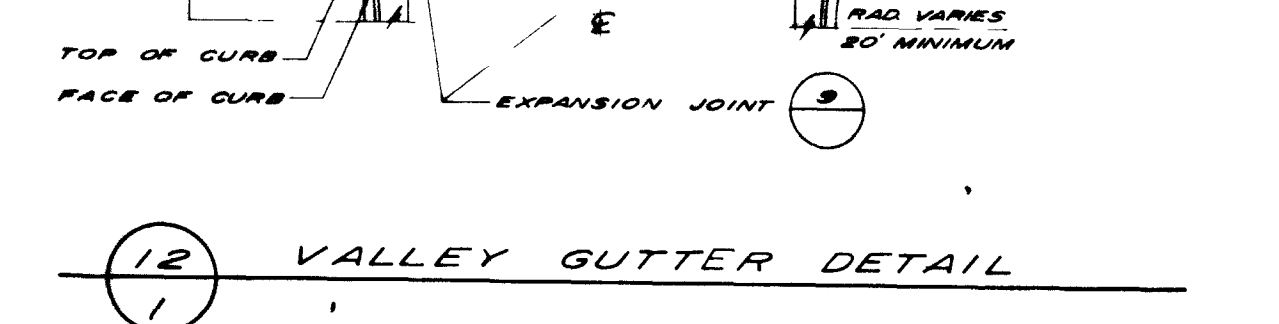

18 VALLEY GUTTER DETAIL

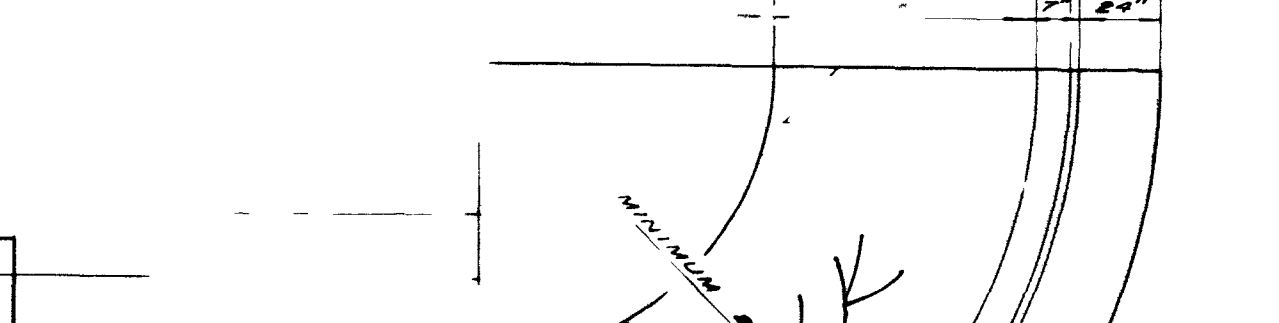

19 CURB RETURN DETAIL



20 CONCRETE SWALE DETAIL

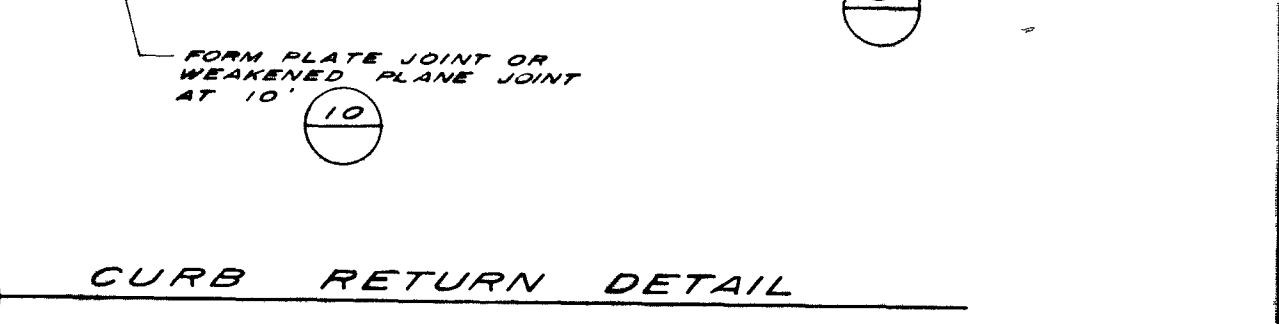

21 CURB RETURN DETAIL

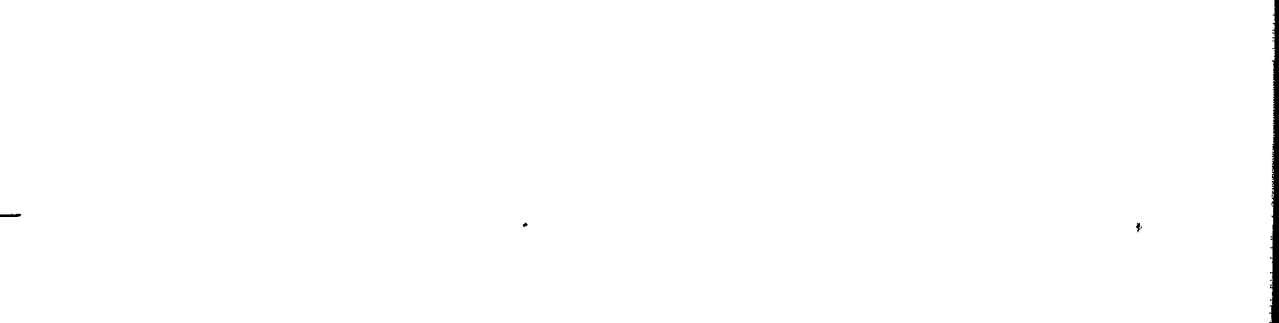

22 CONCRETE SWALE DETAIL

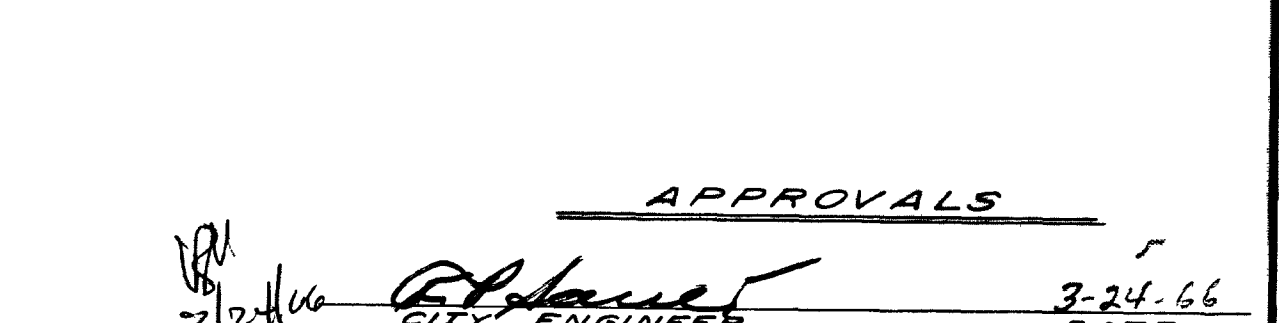

23 CURB RETURN DETAIL

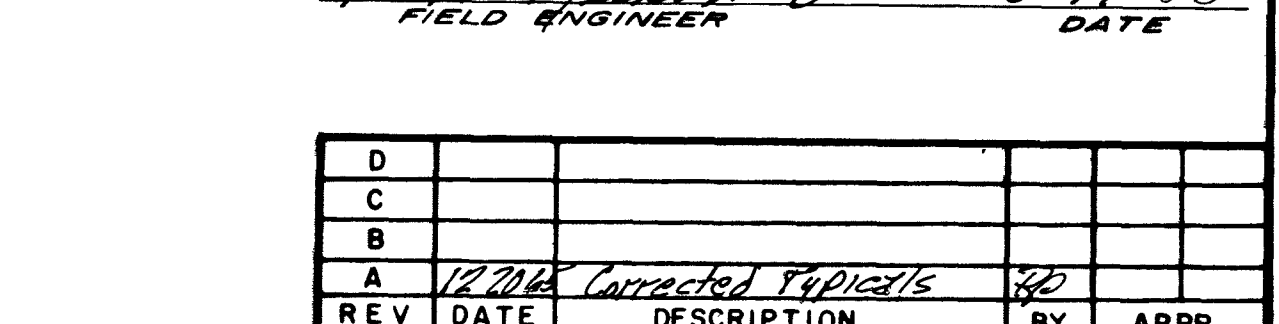

24 CONCRETE SWALE DETAIL

APPROVALS

3/24/66 *[Signature]* CITY ENGINEER 3-24-66 DATE

3-14-66 *[Signature]* FIELD ENGINEER 3-14-66 DATE

| REV | DATE | DESCRIPTION | BY | APPR |
|-----|------|----------------|----|------|
| A | | Corrected Typo | HD | |

PANCHO NEVADA ESTATES
UNIT NO. 2

TYPICAL
STREET DETAILS
NO SCALE

WESTERN ENGINEERS, INC.
LAS VEGAS, NEVADA

APPROVED *[Signature]* DATE 4-1-66

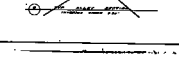
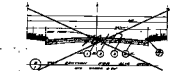
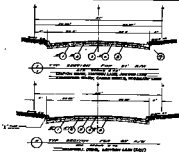

- LEGEND**
- ① - TYPE OF BRIDGE ABUT
 - ② - TYPE OF BRIDGE PIERS
 - ③ - BRIDGE DECK
 - ④ - BRIDGE TRUSS
 - ⑤ - BRIDGE GIRDERS
 - ⑥ - BRIDGE ARCH
 - ⑦ - BRIDGE TOWER
 - ⑧ - BRIDGE Pylon
 - ⑨ - BRIDGE Cable
 - ⑩ - BRIDGE Deck
 - ⑪ - BRIDGE Deck
 - ⑫ - BRIDGE Deck
 - ⑬ - BRIDGE Deck
 - ⑭ - BRIDGE Deck
 - ⑮ - BRIDGE Deck
 - ⑯ - BRIDGE Deck
 - ⑰ - BRIDGE Deck
 - ⑱ - BRIDGE Deck
 - ⑲ - BRIDGE Deck
 - ⑳ - BRIDGE Deck
 - ㉑ - BRIDGE Deck
 - ㉒ - BRIDGE Deck
 - ㉓ - BRIDGE Deck
 - ㉔ - BRIDGE Deck
 - ㉕ - BRIDGE Deck
 - ㉖ - BRIDGE Deck
 - ㉗ - BRIDGE Deck
 - ㉘ - BRIDGE Deck
 - ㉙ - BRIDGE Deck
 - ㉚ - BRIDGE Deck
 - ㉛ - BRIDGE Deck
 - ㉜ - BRIDGE Deck
 - ㉝ - BRIDGE Deck
 - ㉞ - BRIDGE Deck
 - ㉟ - BRIDGE Deck
 - ㊱ - BRIDGE Deck
 - ㊲ - BRIDGE Deck
 - ㊳ - BRIDGE Deck
 - ㊴ - BRIDGE Deck
 - ㊵ - BRIDGE Deck
 - ㊶ - BRIDGE Deck
 - ㊷ - BRIDGE Deck
 - ㊸ - BRIDGE Deck
 - ㊹ - BRIDGE Deck
 - ㊺ - BRIDGE Deck
 - ㊻ - BRIDGE Deck
 - ㊼ - BRIDGE Deck
 - ㊽ - BRIDGE Deck
 - ㊾ - BRIDGE Deck
 - ㊿ - BRIDGE Deck

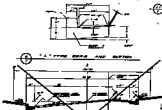

| BRIDGE DATA | |
|-------------|--------|
| NO. | NAME |
| 1 | BRIDGE |
| 2 | BRIDGE |
| 3 | BRIDGE |
| 4 | BRIDGE |
| 5 | BRIDGE |
| 6 | BRIDGE |
| 7 | BRIDGE |
| 8 | BRIDGE |
| 9 | BRIDGE |
| 10 | BRIDGE |
| 11 | BRIDGE |
| 12 | BRIDGE |
| 13 | BRIDGE |
| 14 | BRIDGE |
| 15 | BRIDGE |
| 16 | BRIDGE |
| 17 | BRIDGE |
| 18 | BRIDGE |
| 19 | BRIDGE |
| 20 | BRIDGE |
| 21 | BRIDGE |
| 22 | BRIDGE |
| 23 | BRIDGE |
| 24 | BRIDGE |
| 25 | BRIDGE |
| 26 | BRIDGE |
| 27 | BRIDGE |
| 28 | BRIDGE |
| 29 | BRIDGE |
| 30 | BRIDGE |
| 31 | BRIDGE |
| 32 | BRIDGE |
| 33 | BRIDGE |
| 34 | BRIDGE |
| 35 | BRIDGE |
| 36 | BRIDGE |
| 37 | BRIDGE |
| 38 | BRIDGE |
| 39 | BRIDGE |
| 40 | BRIDGE |
| 41 | BRIDGE |
| 42 | BRIDGE |
| 43 | BRIDGE |
| 44 | BRIDGE |
| 45 | BRIDGE |
| 46 | BRIDGE |
| 47 | BRIDGE |
| 48 | BRIDGE |
| 49 | BRIDGE |
| 50 | BRIDGE |

