

**A SECTION**  
C3.2 NOT TO SCALE

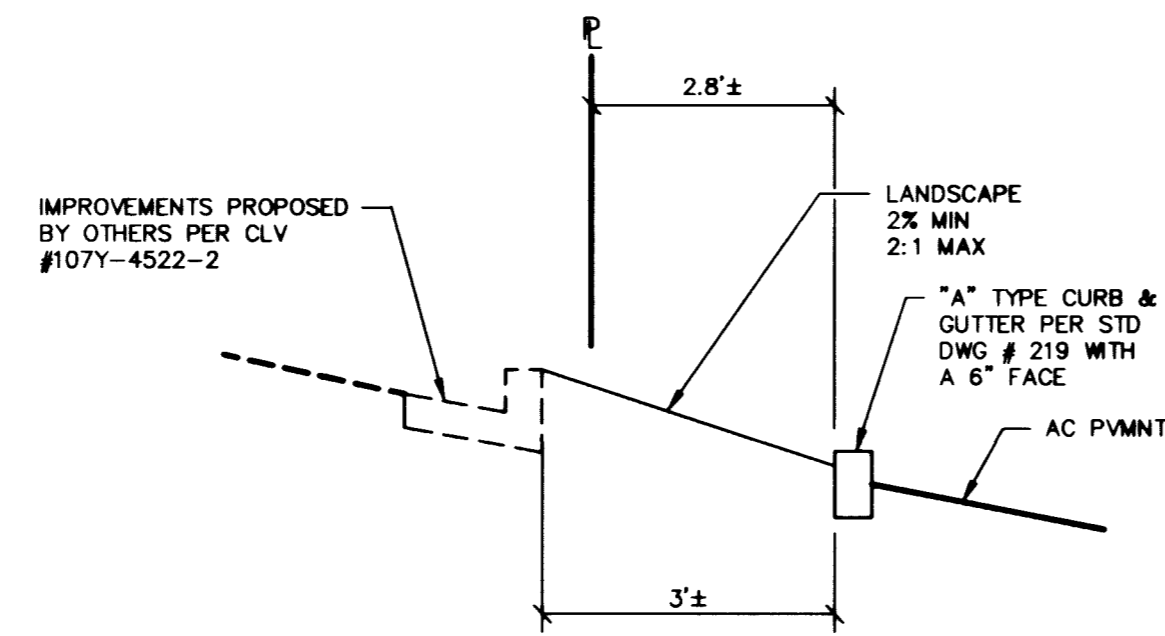

**B SECTION**  
C3.2 NOT TO SCALE

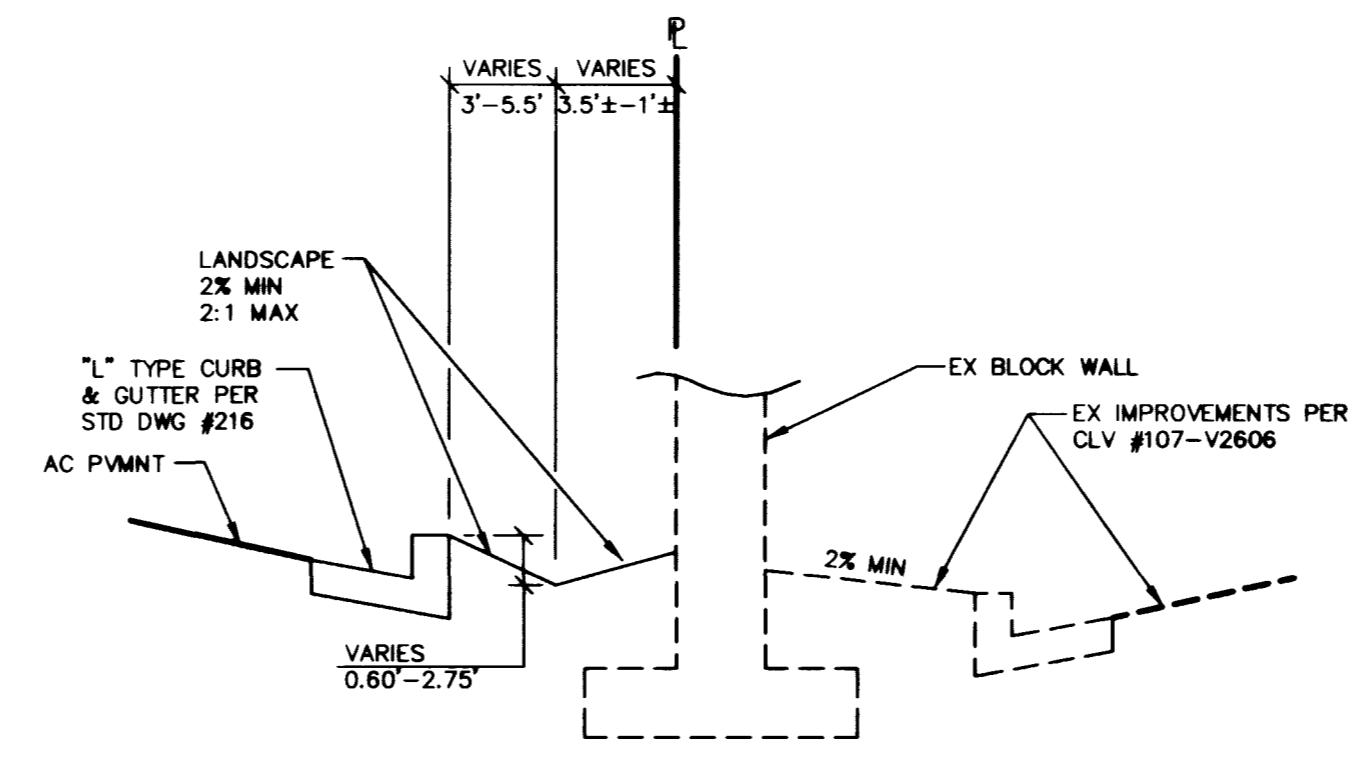

**C SECTION**  
C3.2 NOT TO SCALE

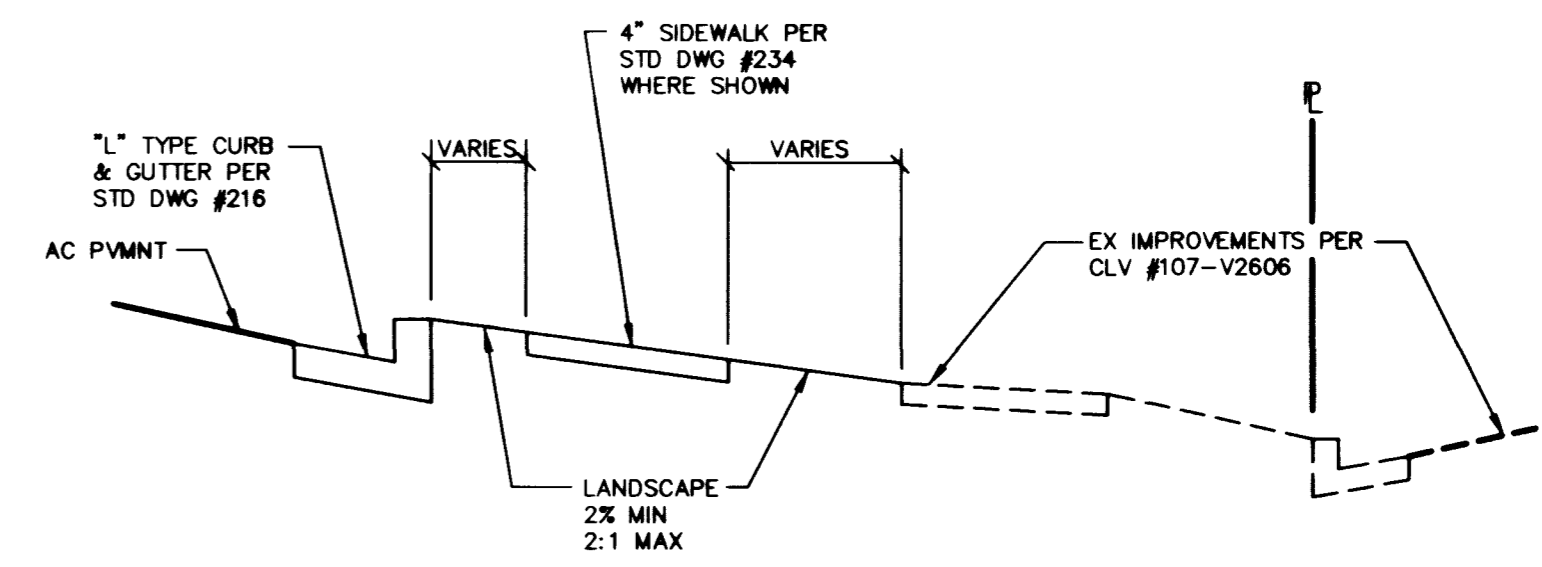

**D SECTION**  
C3.2 NOT TO SCALE

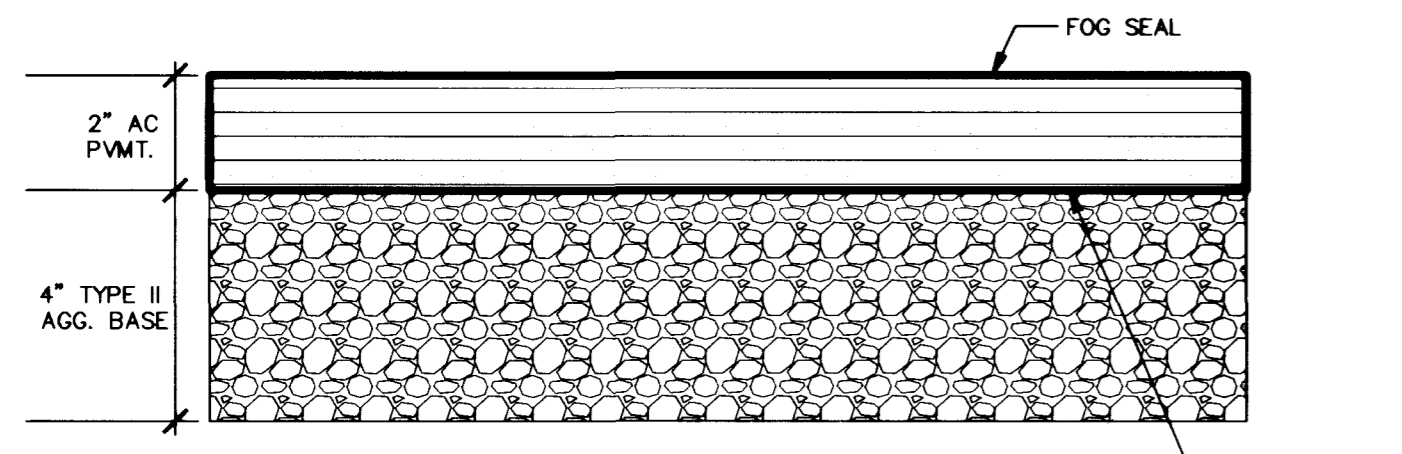

**2' AC PAVING DETAIL**  
NOT TO SCALE

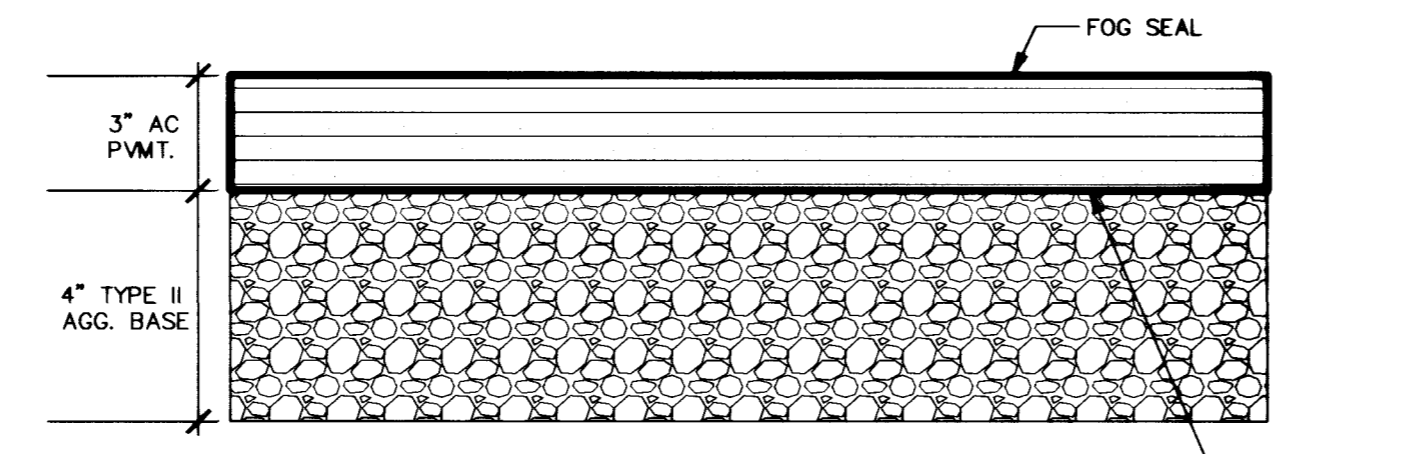

**3' AC PAVING DETAIL**  
NOT TO SCALE

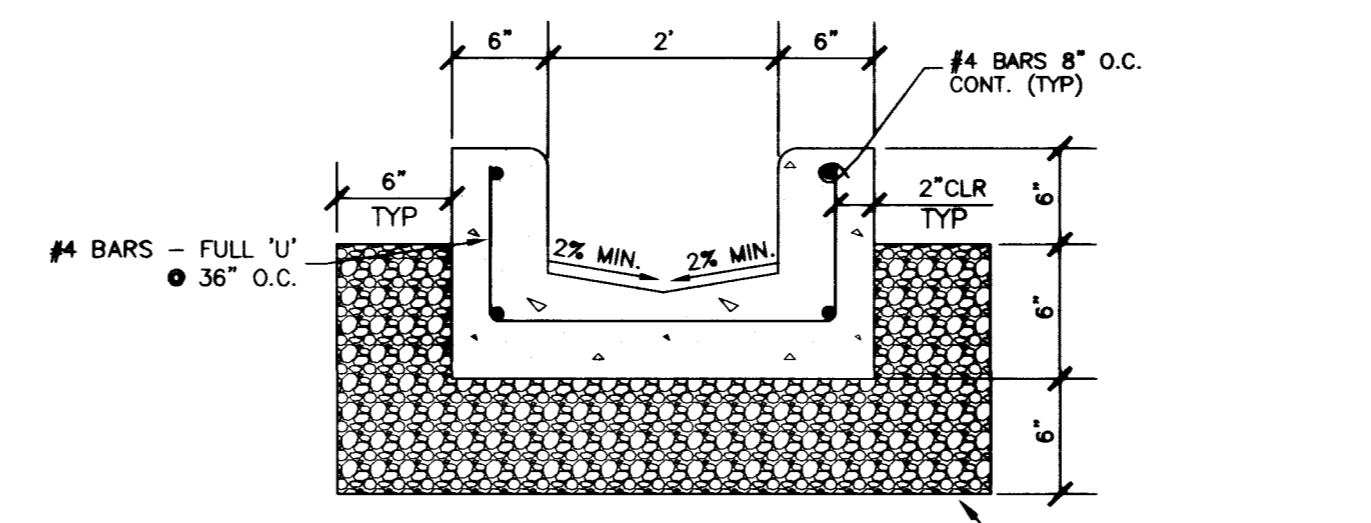

**2' CONCRETE FLUME**  
NOT TO SCALE

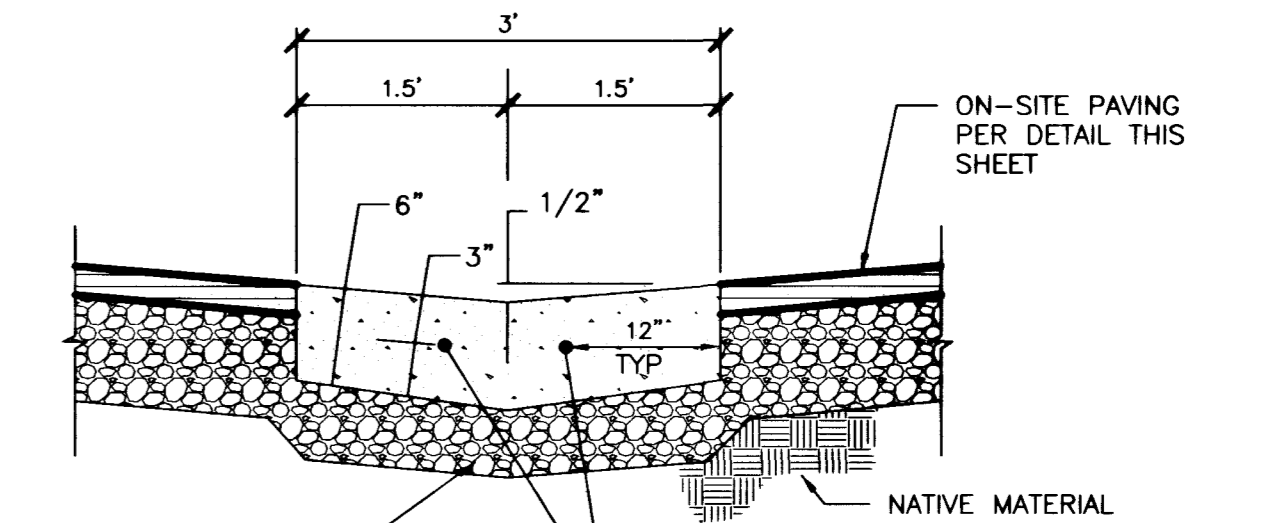

**3' CONCRETE SWALE**  
NOT TO SCALE

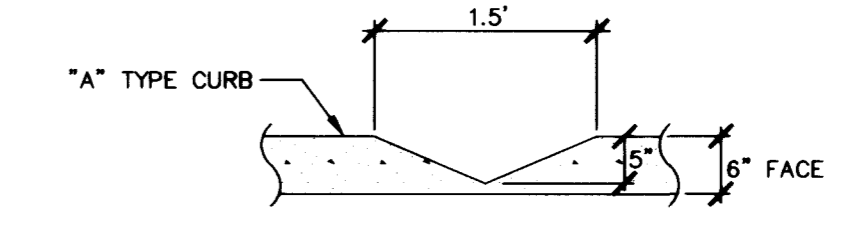

**V-NOTCH CURB DETAIL**  
NOT TO SCALE

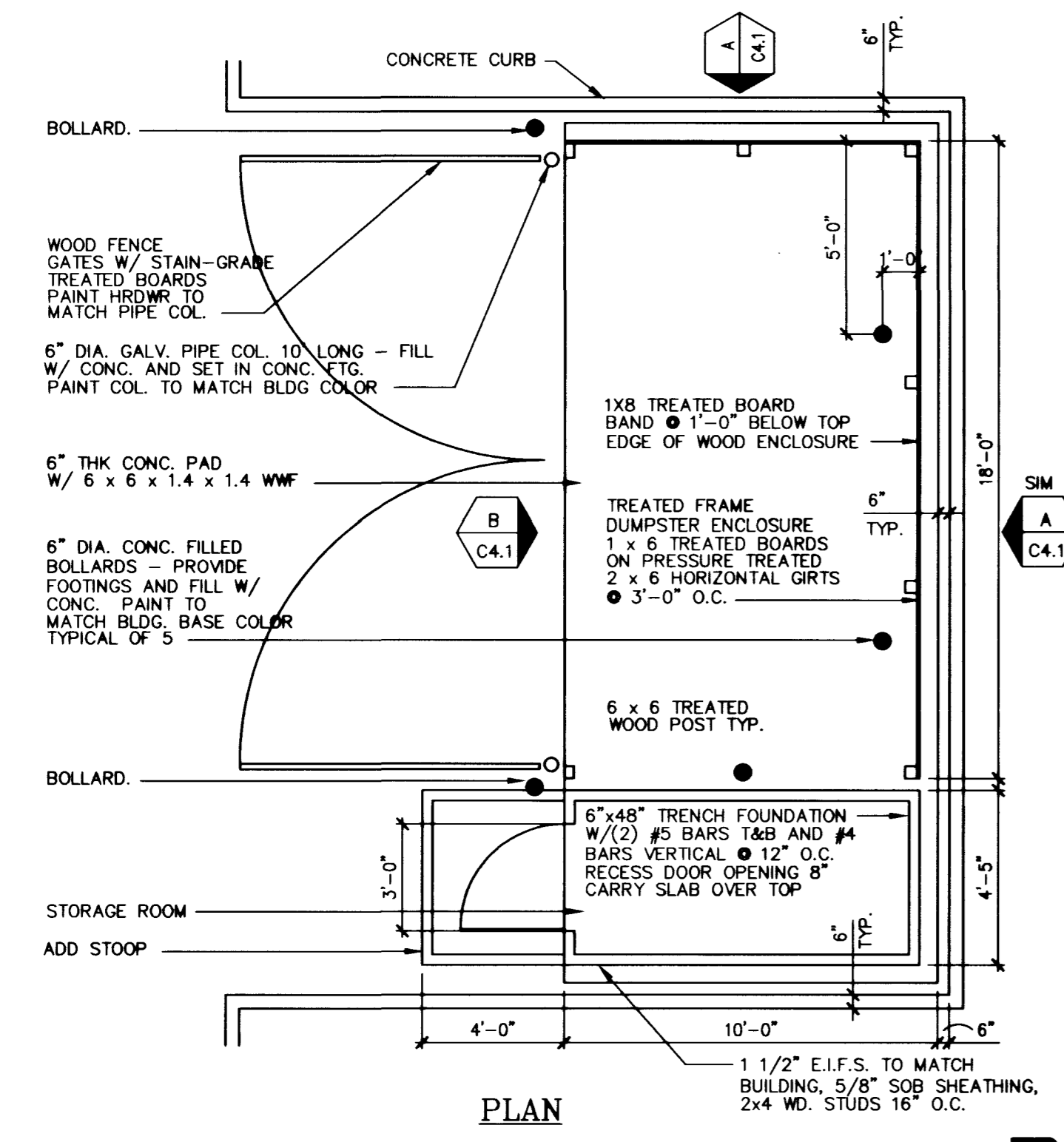

**PLAN**

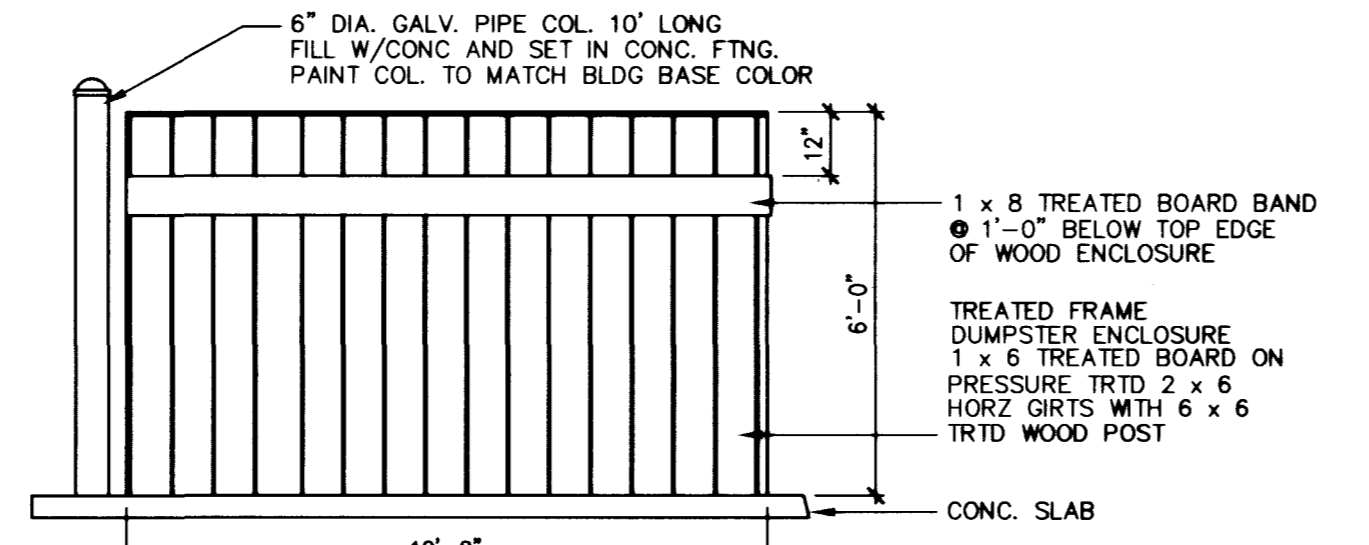

**A ELEVATION**

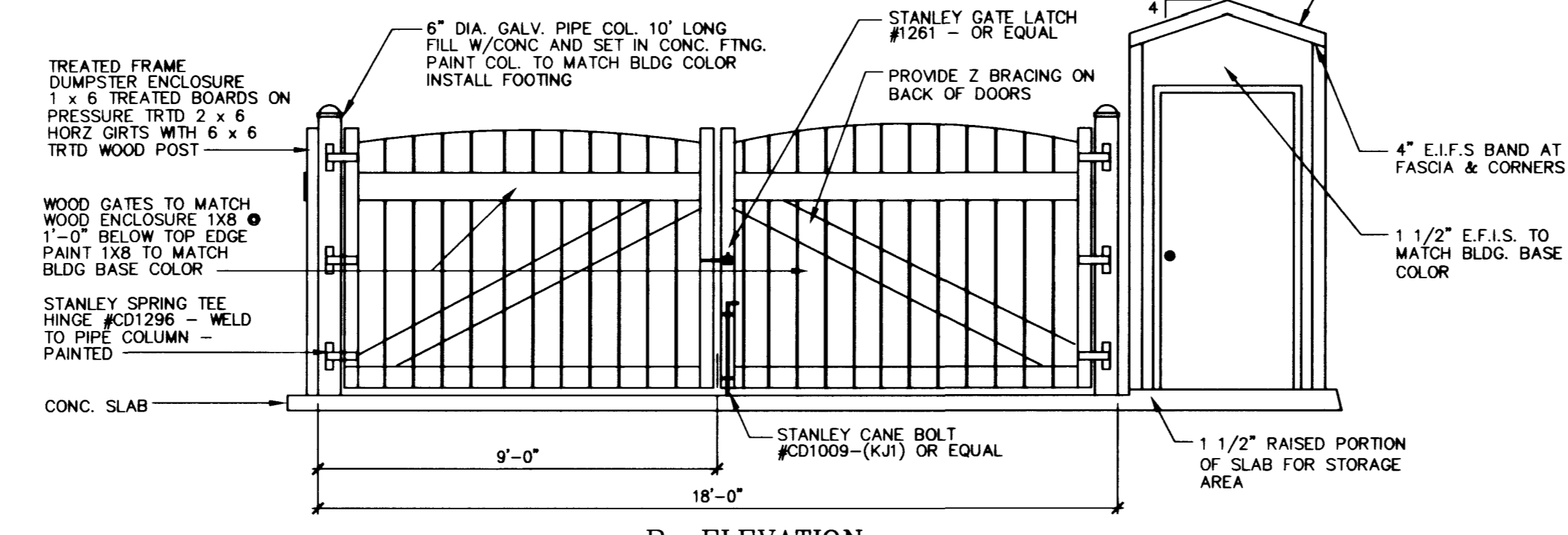

**B ELEVATION**

**TRASH ENCLOSURE DETAIL**  
NOT TO SCALE

NOTE:  
DETAIL SHOWN FOR REFERENCE ONLY, CONSTRUCTED PER ARCHITECT'S SPECIFICATION.

REV	DATE	BY	REVISION

**HOSPITALITY ASSOCIATES**  
3808 N. SULLIVAN RD., BLDG. #04  
SPokane, WA, 99216  
(509) 928-3736

**EKN ENGINEERING**  
Engineers/Planners/Surveyors  
205 East Warm Springs Road, Suite 100  
LAS VEGAS, NV, 89119 (702) 885-6604

**GRADING DETAILS**

**HAWTHORN SUITES LTD**  
SAHARA AVE. and FORT APACHE ROAD-  
CITY OF LAS VEGAS NEVADA

SHEET	2/1/99
DESIGNED BY:	J.W. REPLY
CHECKED BY:	D.E. PETERS
PROJECT NO.:	99-503
SCALE:	NOT TO SCALE

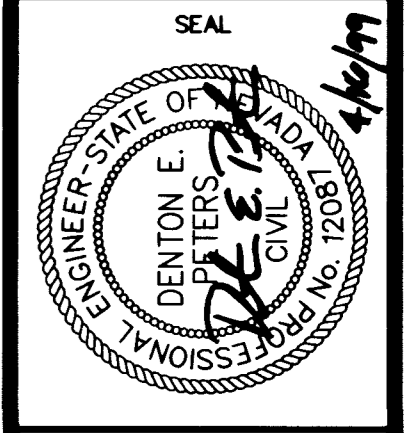

**Call before you OVERHEAD**  
1-702-593-6111  
SAFETY SERVICES COMPANY

**Call before you Dig.**  
1-800-227-2600  
UNDERGROUND SERVICE ALERT (USA)

SHEET  
**C3.2**  
7 OF 10 SHEETS  
DRAWING NO.  
**107-V3073**



SECTION  
1-1

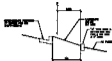

SECTION  
2-2



SECTION  
3-3



SECTION  
4-4



AL FRAME DETAIL  
1/2" x 1/2"



AL FRAME DETAIL  
1/2" x 1/2"



CONCRETE FRAME  
1/2" x 1/2"

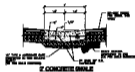

CONCRETE FRAME  
1/2" x 1/2"



WINDOW CURB DETAIL  
1/2" x 1/2"

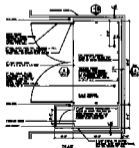

TRASH ENCLOSURE DETAIL  
1/2" x 1/2"



1/2" x 1/2"

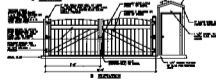

1/2" x 1/2"

HOSPITALITY ASSOCIATES  
EKN  
HARTFORD BUILDING LTD.  
ARCHITECTS AND INTERIORS INC.  
HARTFORD, CONNECTICUT

ENGINEERING  
HARTFORD, CONNECTICUT

Call  
before you  
order  
Call  
before you  
order  
Call  
before you  
order



Call  
before you  
order  
Call  
before you  
order  
Call  
before you  
order