

DATE: 02-15-06
REV. DATE: 08-12-03
DESCRIPTION: BANDERA MOUNTAIN LANE STORM DRAIN LATERAL DETAIL STA. 20+38.51

DESIGN: G.C. WALLACE, INC.
DRAWN: G.C. WALLACE, INC.
CHECK: G.C. WALLACE, INC.
ISSUE DATE: 02-15-06
ISSUE EDITOR: G.C. WALLACE, INC.
PLOT DATE: 02-15-06
PLOT TIME: 08:12:43

G.C. WALLACE, INC.
Engineers/Planners/Surveyors
1555 SOUTH RAINBOW BLVD., LAS VEGAS, NEVADA 89146
TELEPHONE: (702) 864-2600 • FAX: (702) 864-2289
In Northern Terrace Units Nevada, NV 89134

MERTAGE CORPORATION
NORTHERN TERRACE - UNIT 4
GRADING DETAILS

DRAWING
C-13
13 OF 15 SHTS

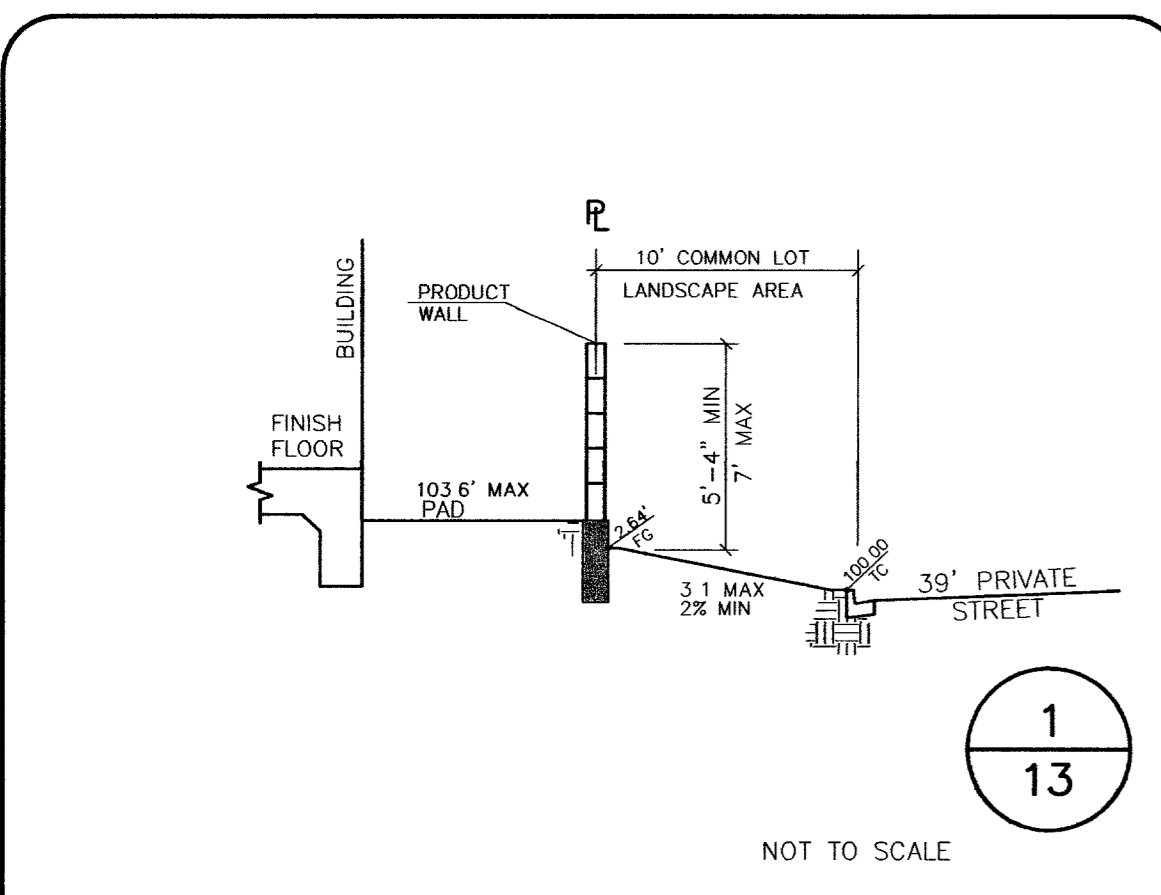

1
13

NOT TO SCALE

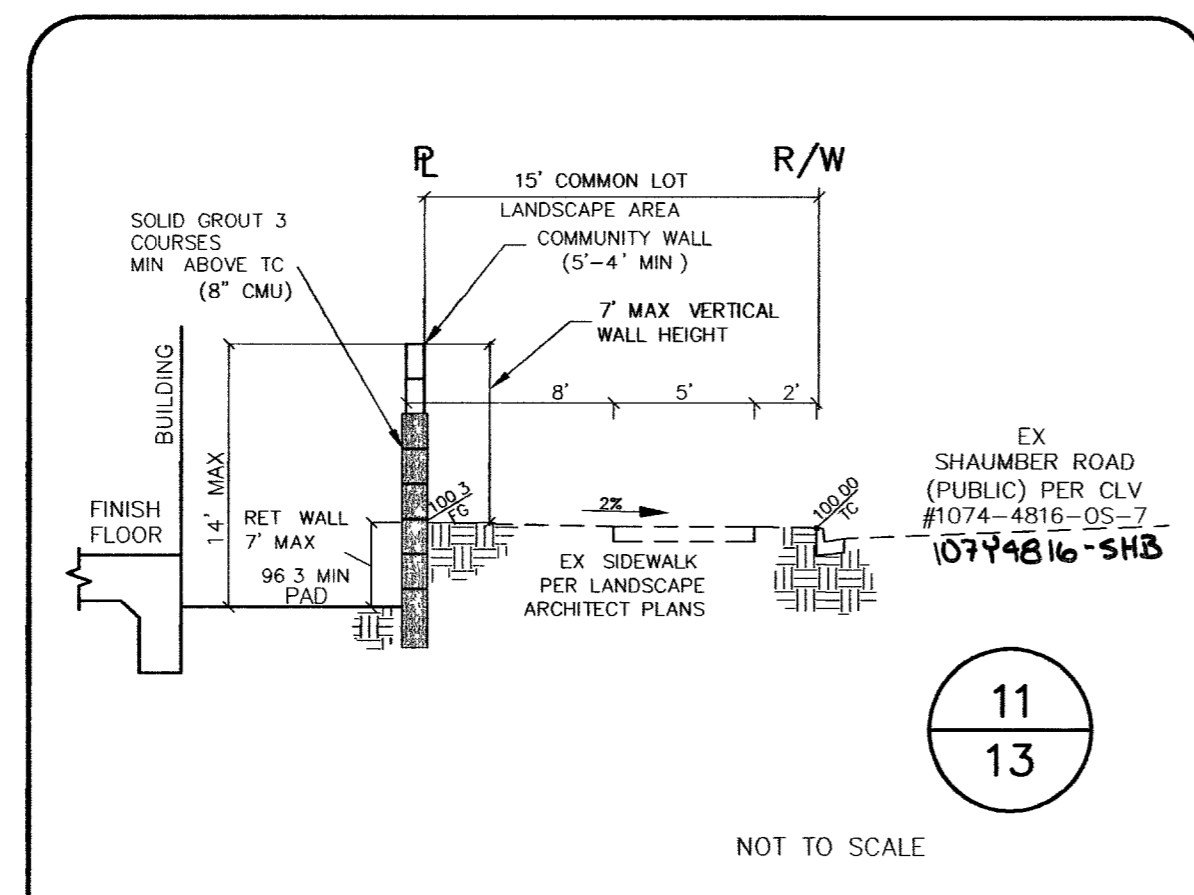

11
13

NOT TO SCALE

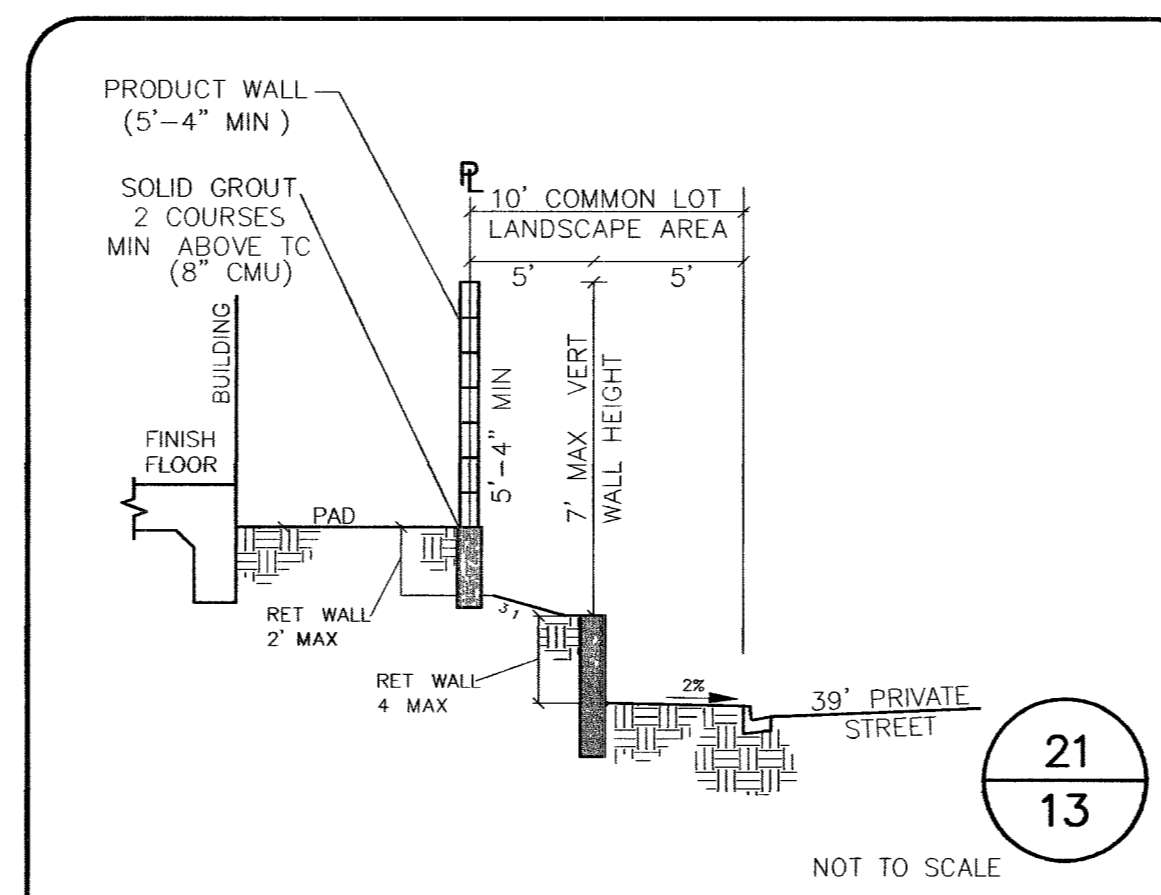

21
13

NOT TO SCALE

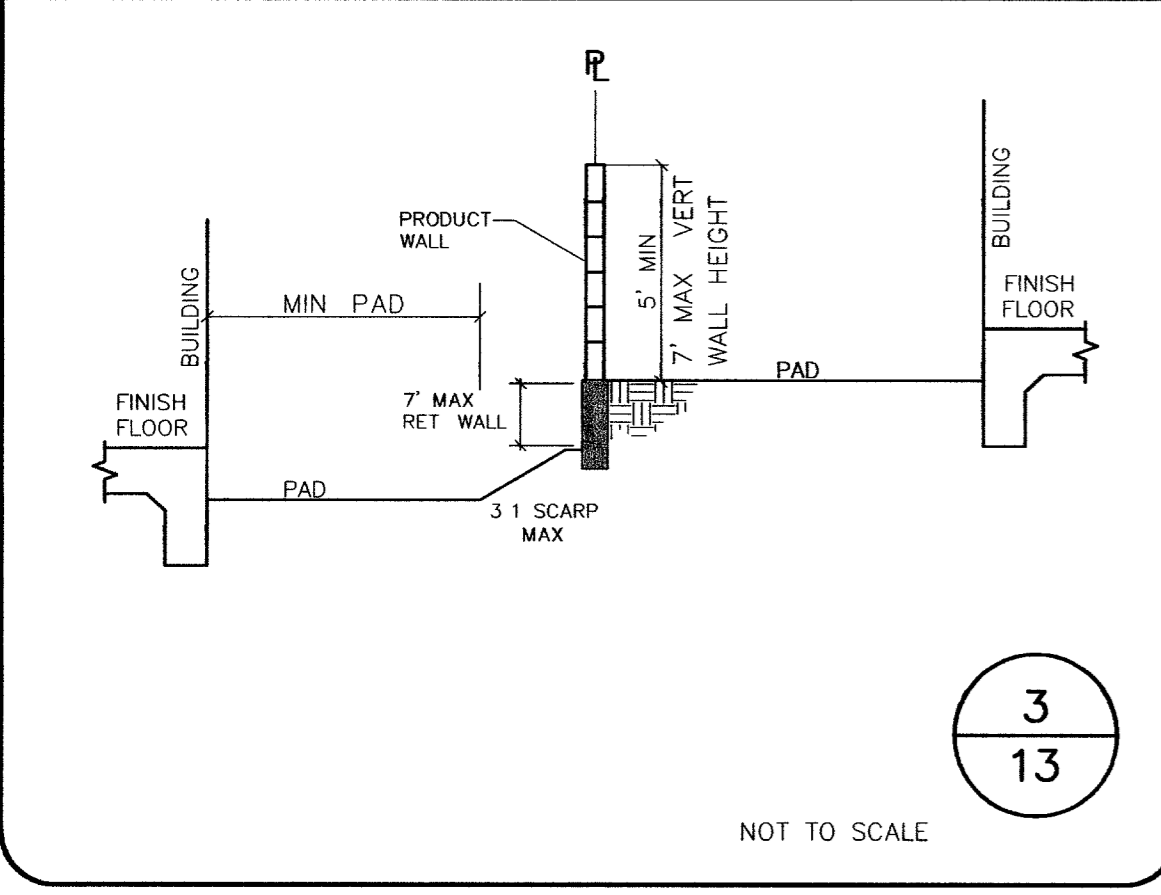

3
13

NOT TO SCALE

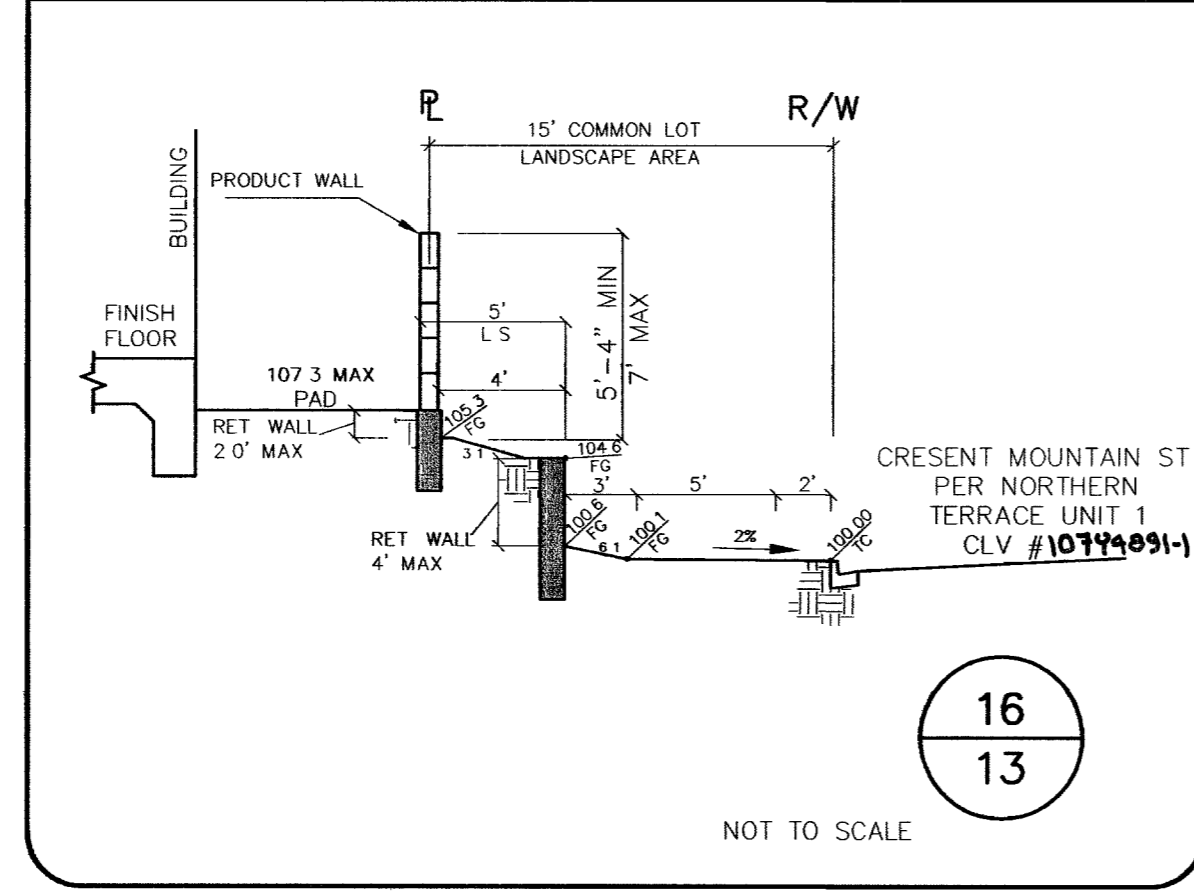

16
13

NOT TO SCALE

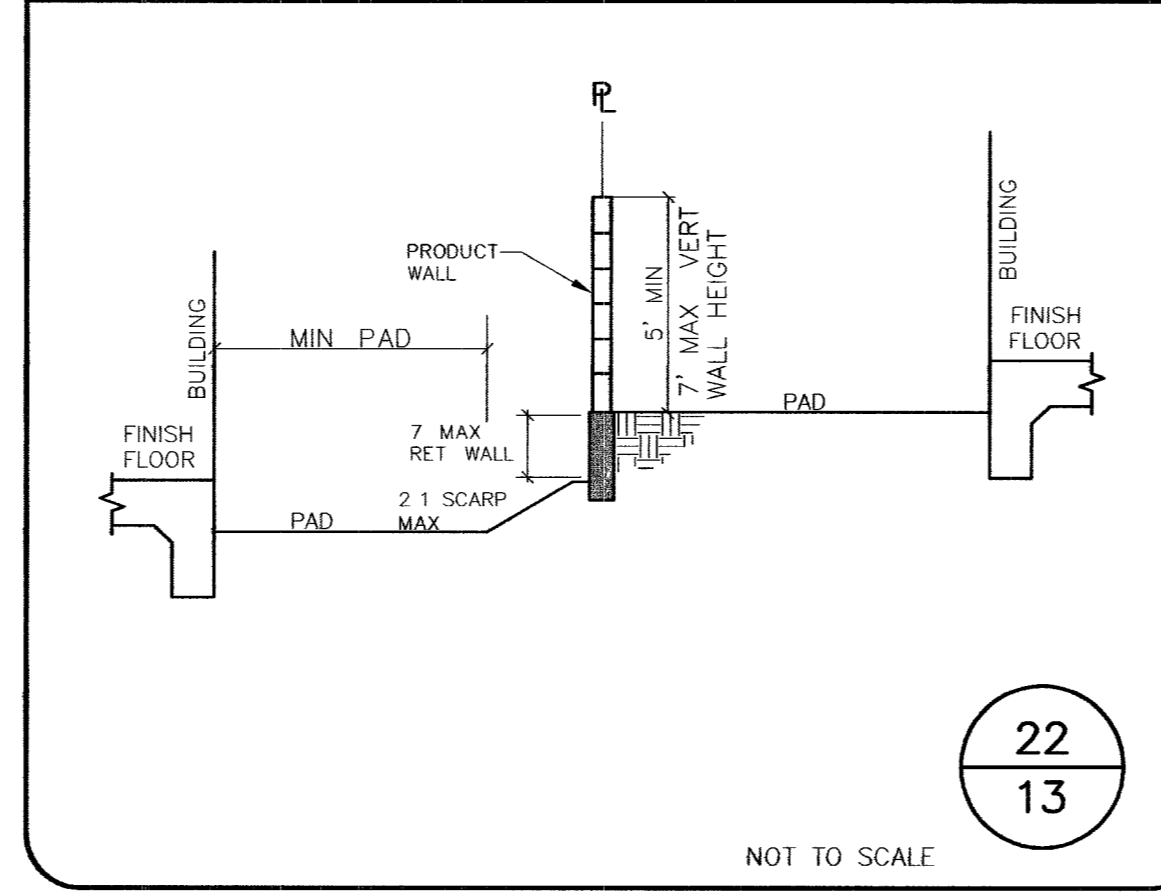

22
13

NOT TO SCALE

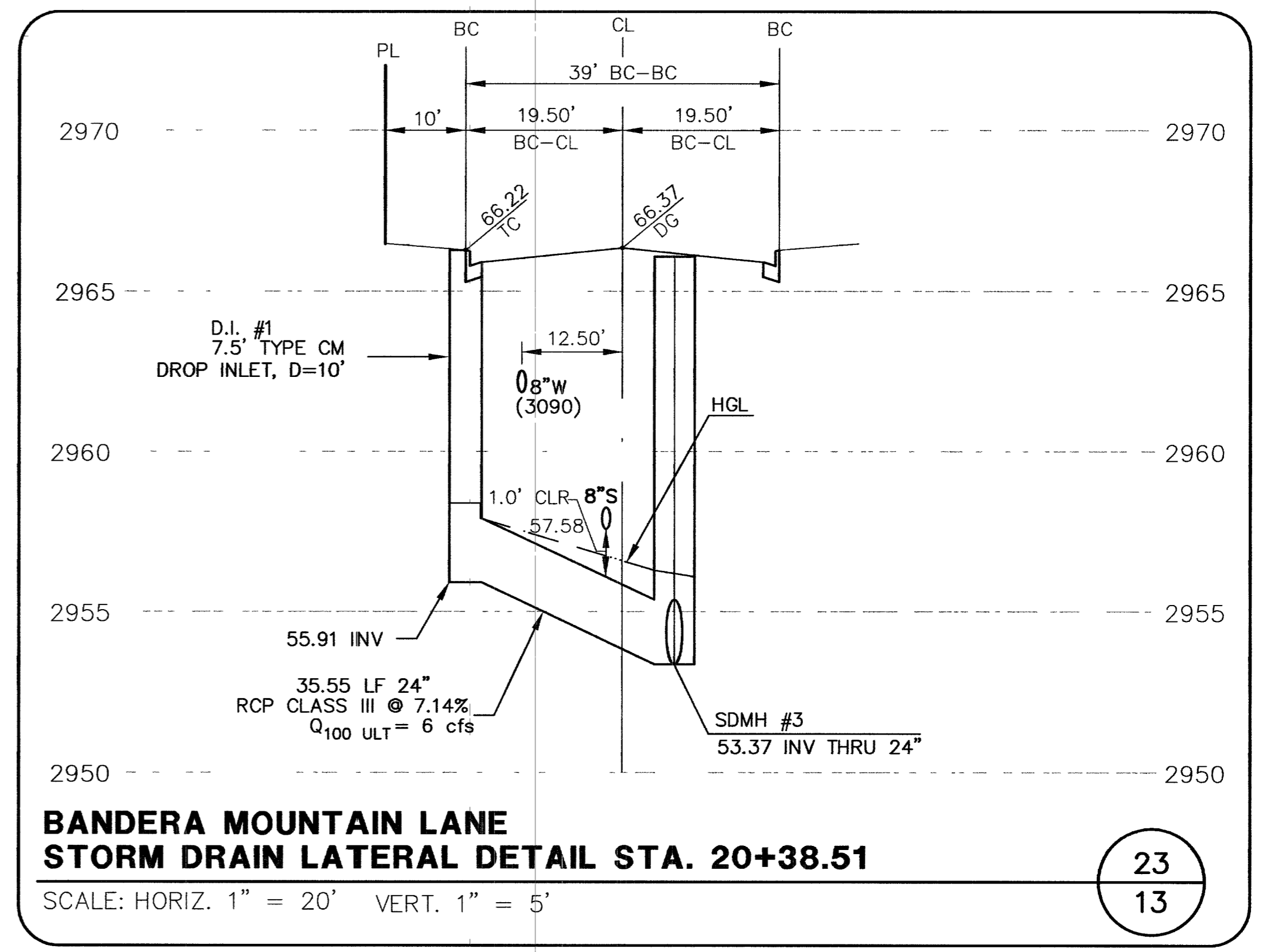

23
13

BANDERA MOUNTAIN LANE STORM DRAIN LATERAL DETAIL STA. 20+38.51

SCALE: HORIZ. 1" = 20' VERT. 1" = 5'

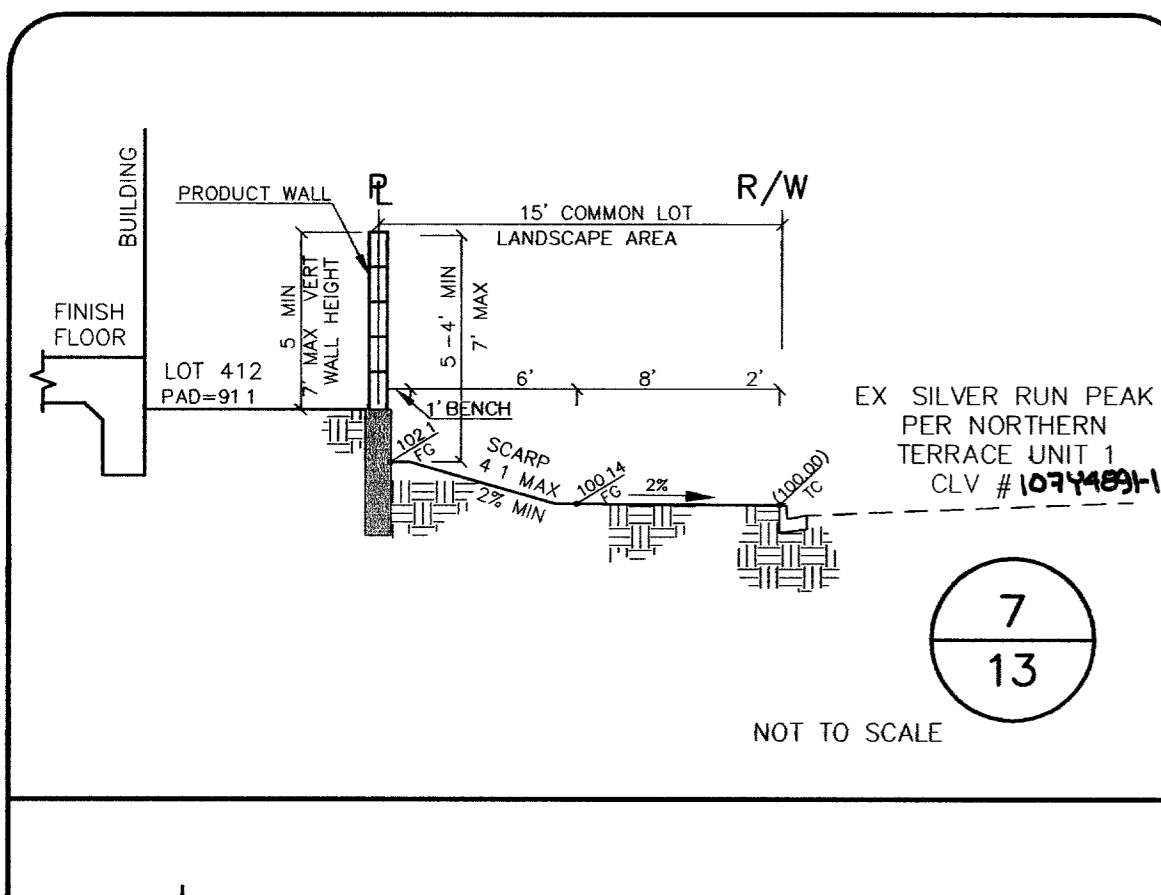

7
13

NOT TO SCALE

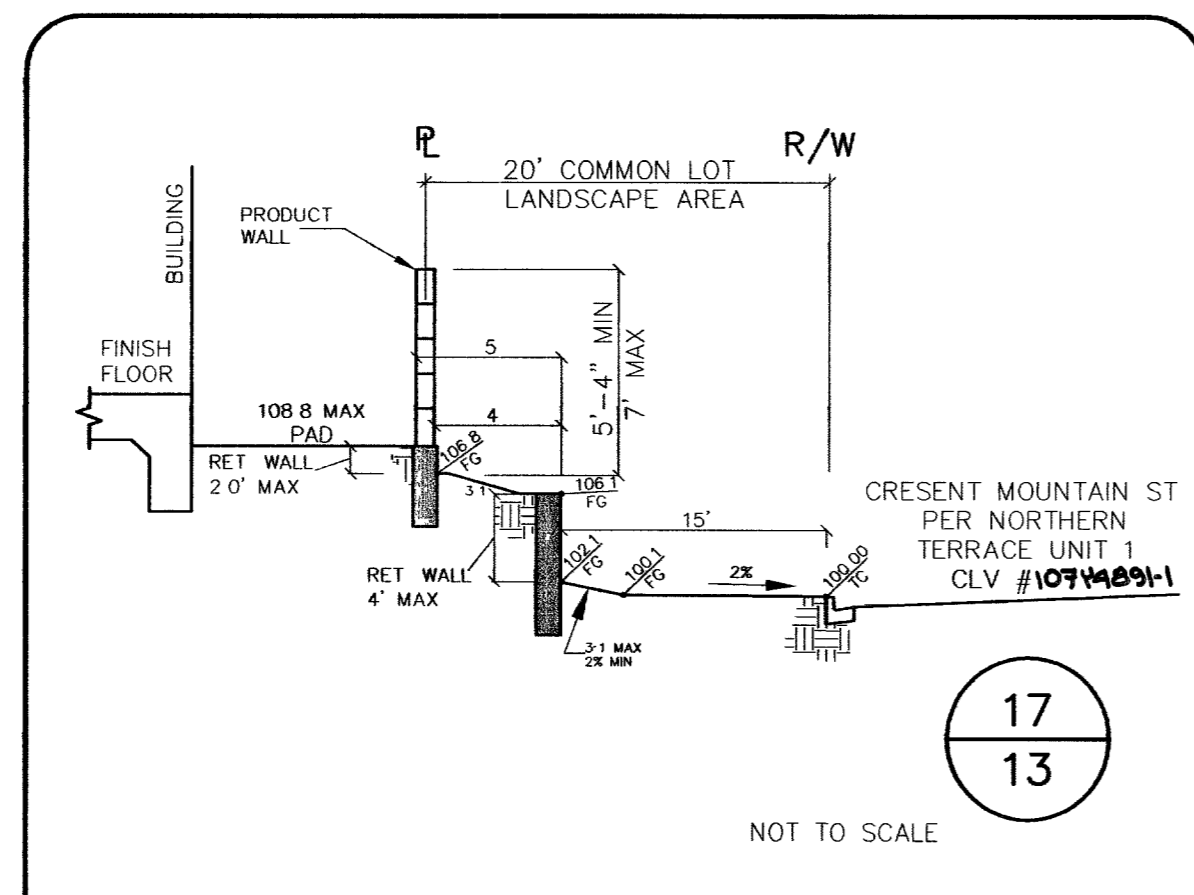

17
13

NOT TO SCALE

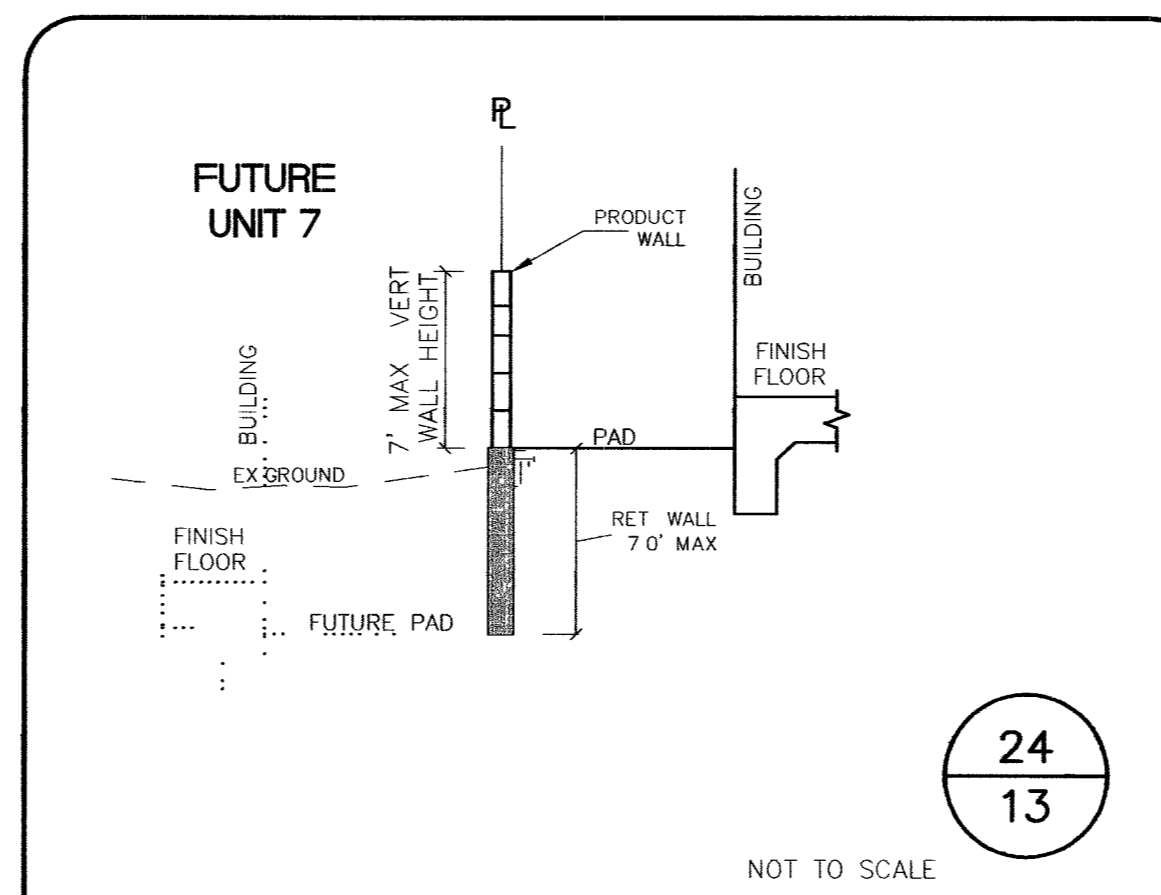

24
13

NOT TO SCALE

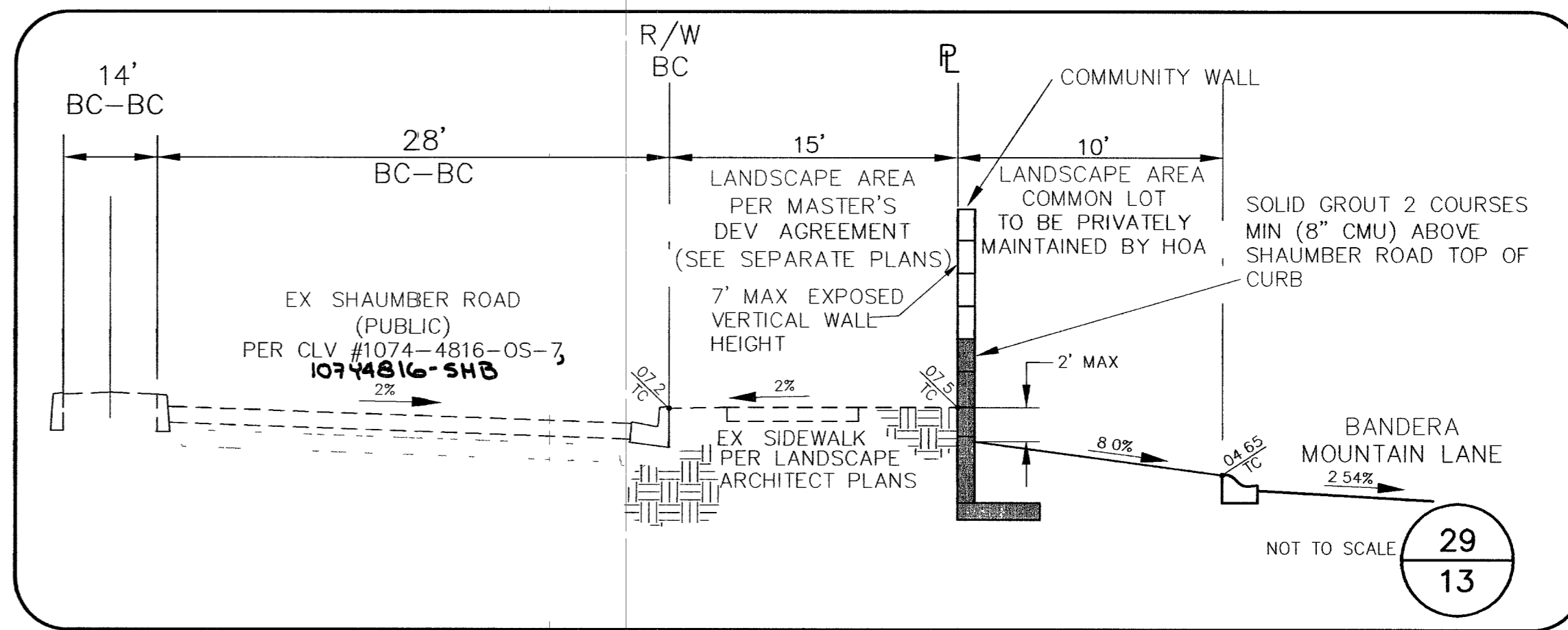

29
13

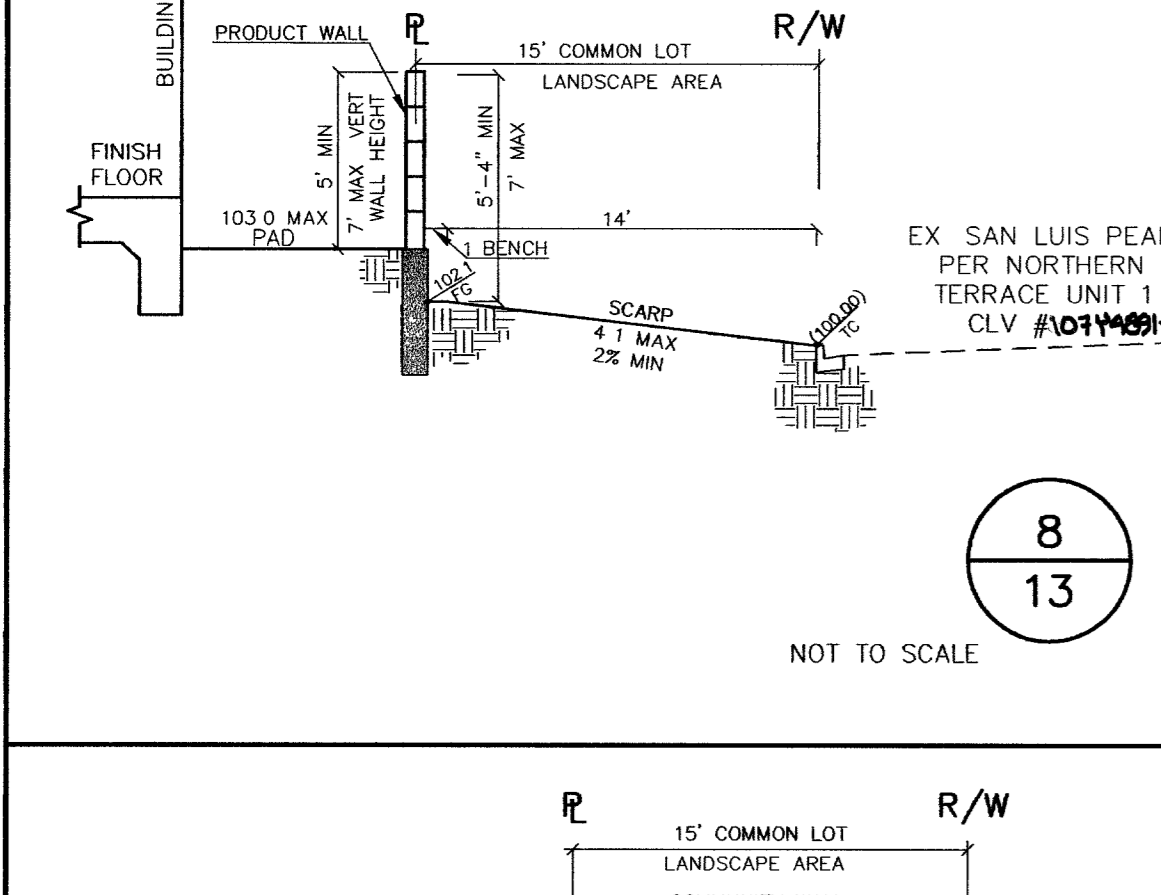

8
13

NOT TO SCALE

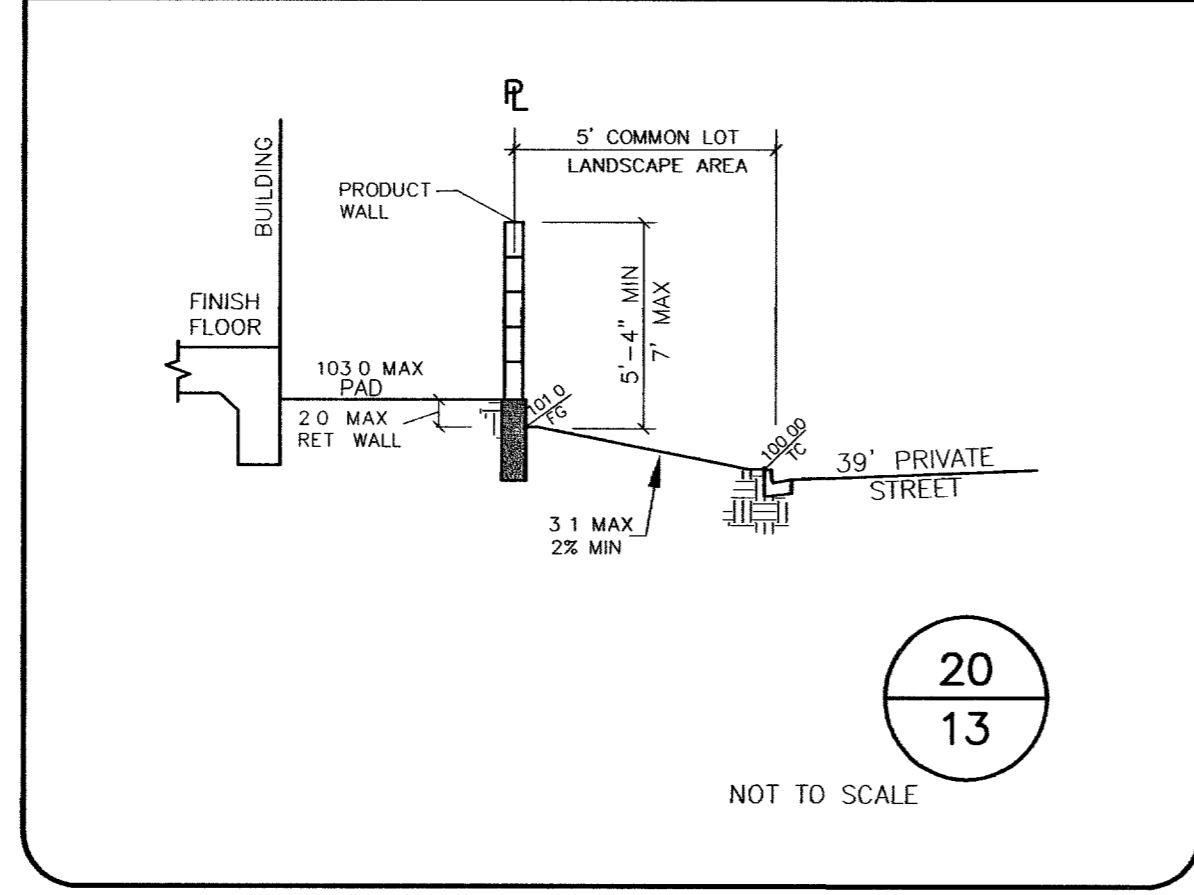

20
13

NOT TO SCALE

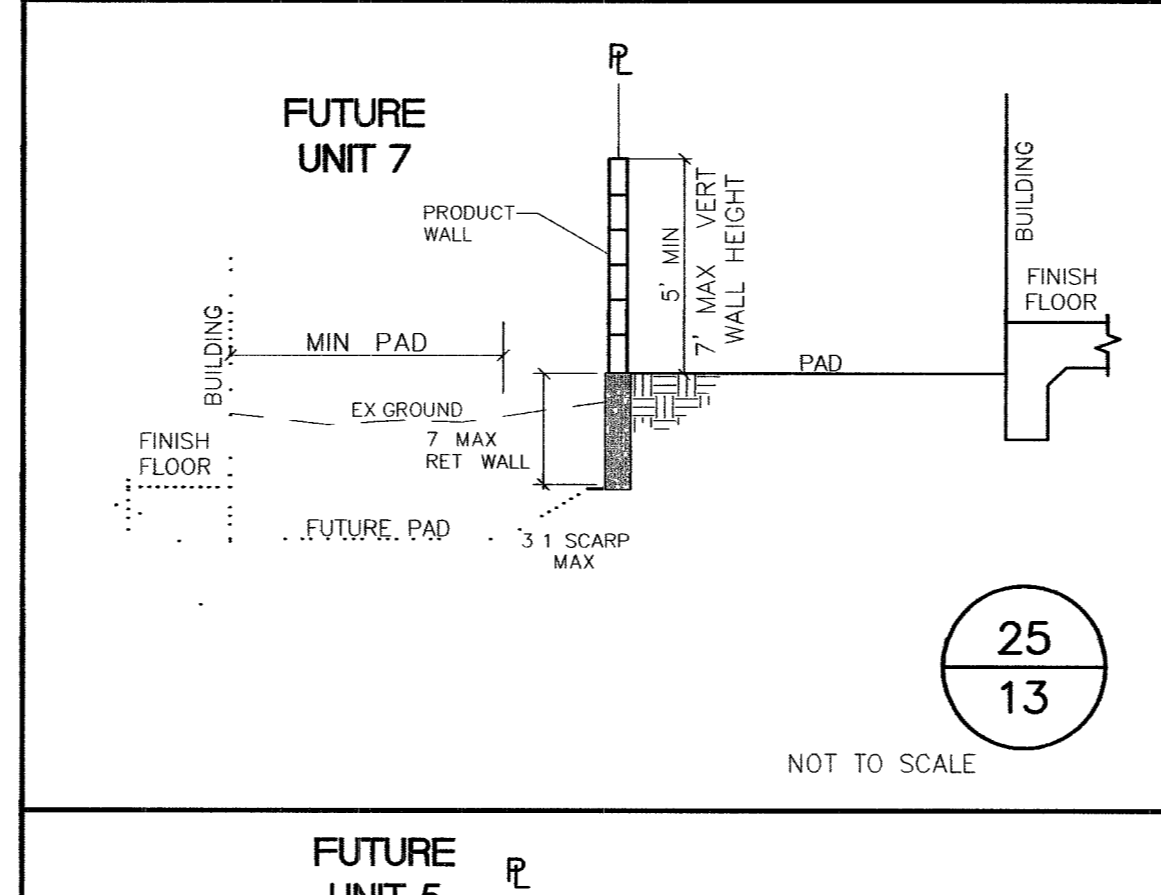

25
13

NOT TO SCALE

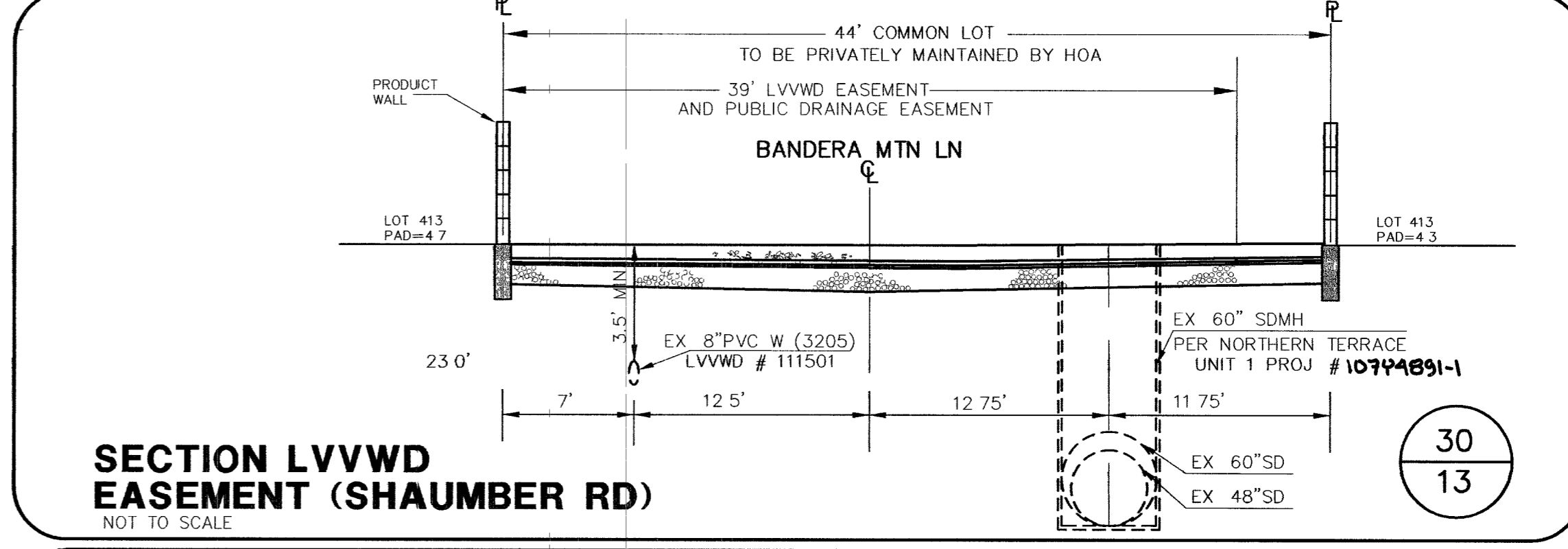

30
13

SECTION LVVWD EASEMENT (SHAUMBER RD)

NOT TO SCALE

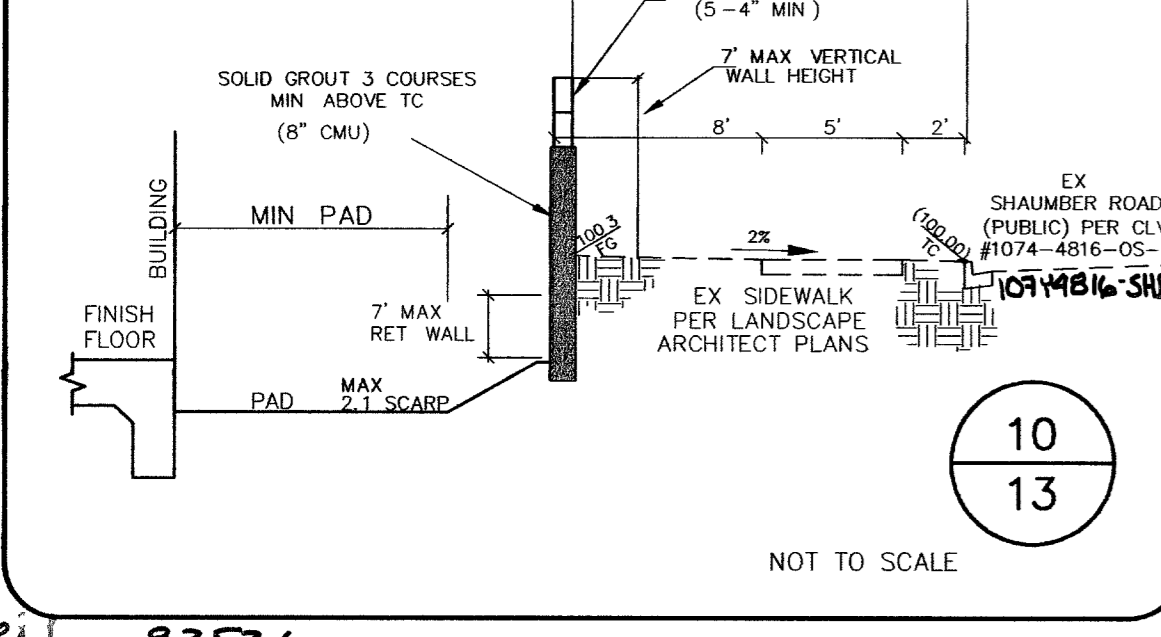

10
13

NOT TO SCALE

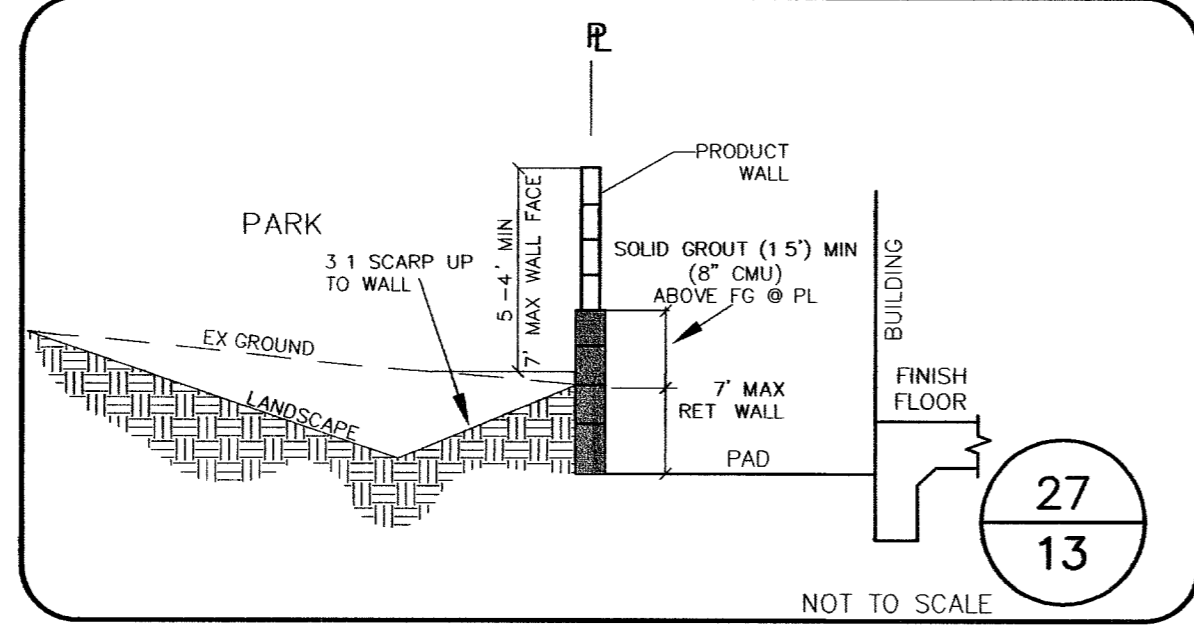

27
13

NOT TO SCALE

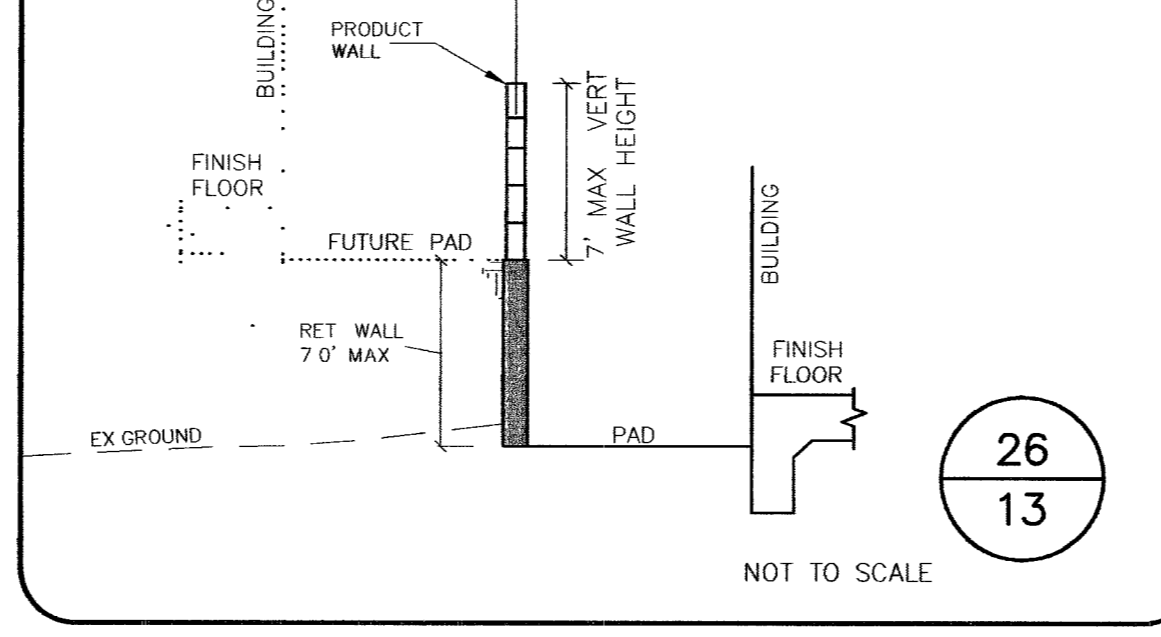

26
13

NOT TO SCALE

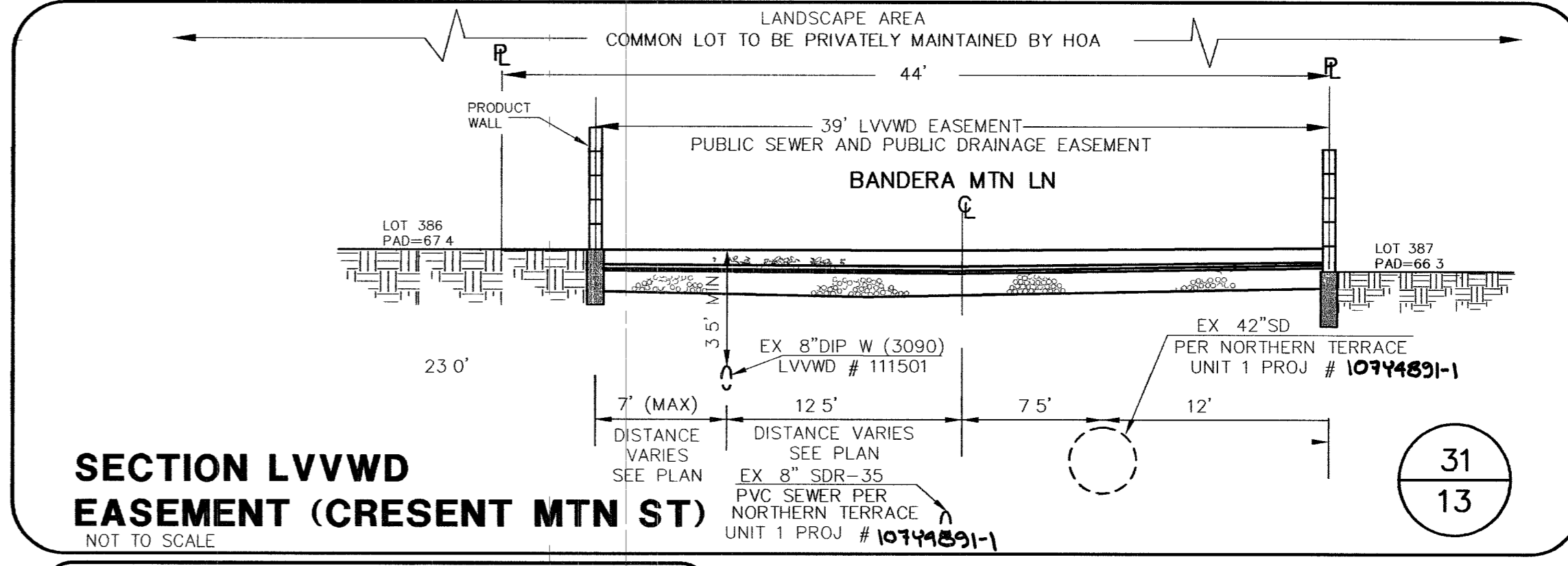

31
13

SECTION LVVWD EASEMENT (CRESENT MTN ST)

NOT TO SCALE

APPROVAL: [Signature]
LAS VEGAS VALLEY WATER DISTRICT
LVVWD # 111607
DATE: 6-15-06

CLV DRAWING NO. 10744891-4

88586 2253