

# ROOM FINISH SCHEDULE

ROOM NAME	FLOOR	BASE		WALLS				CEILING			DOORS		DOOR FRAME		TRIM & MOLD		WINDOWS		METAL WORK	REMARKS				
		MAT.	FIN.	MAT.	FIN.	NORTH		EAST		SOUTH		MAT.	FIN.	HT.	MAT.	FIN.	MAT.	FIN.	MAT.		FIN.			
						MAT.	FIN.	MAT.	FIN.	MAT.	FIN.													
NEW BATHROOM		CER. TILE		WD	2	GYPS	1	GYPS	1	GYPS	1	GYPS	1	8'0"	WOOD		WOOD	2			STEEL	3		
NEW CLOSET		CARPET		WD	2	GYPS	1	CONC BLK	1	CONC BLK	1	GYPS	1	8'0"	WOOD		WOOD	2		SHELVES	2		STEEL	3
NEW MASTER BEDRM		CARPET		WD	2	CONC BLK	1	GYPS	1	CONC BLK	1	GYPS	1	8'0"	WOOD		WOOD	2						
NEW HALL		EXIST		WD-EXIST	2	CONC BLK	1	GYPS	1	CONC BLK	1	GYPS	1	8'0"	WOOD		WOOD	2						
NEW BEDROOM		EXIST		WD-EXIST	2	GYPS	1	GYPS	1	CONC BLK	1	GYPS	1	8'0"	WOOD		WOOD	2						
NEW STUDY		EXIST		WD-EXIST	2	GYPS	1	GYPS	1	CONC BLK	1	GYPS	1	8'0"	WOOD		WOOD	2						
EXISTING HALL		CARPET		EXIST		EXIST	1			EXIST	1													
EXT OUTLOOKERS					2																			
EXTERIOR SHINGLES					7																			
NEW EXT. BLOCK WALLS					6																			

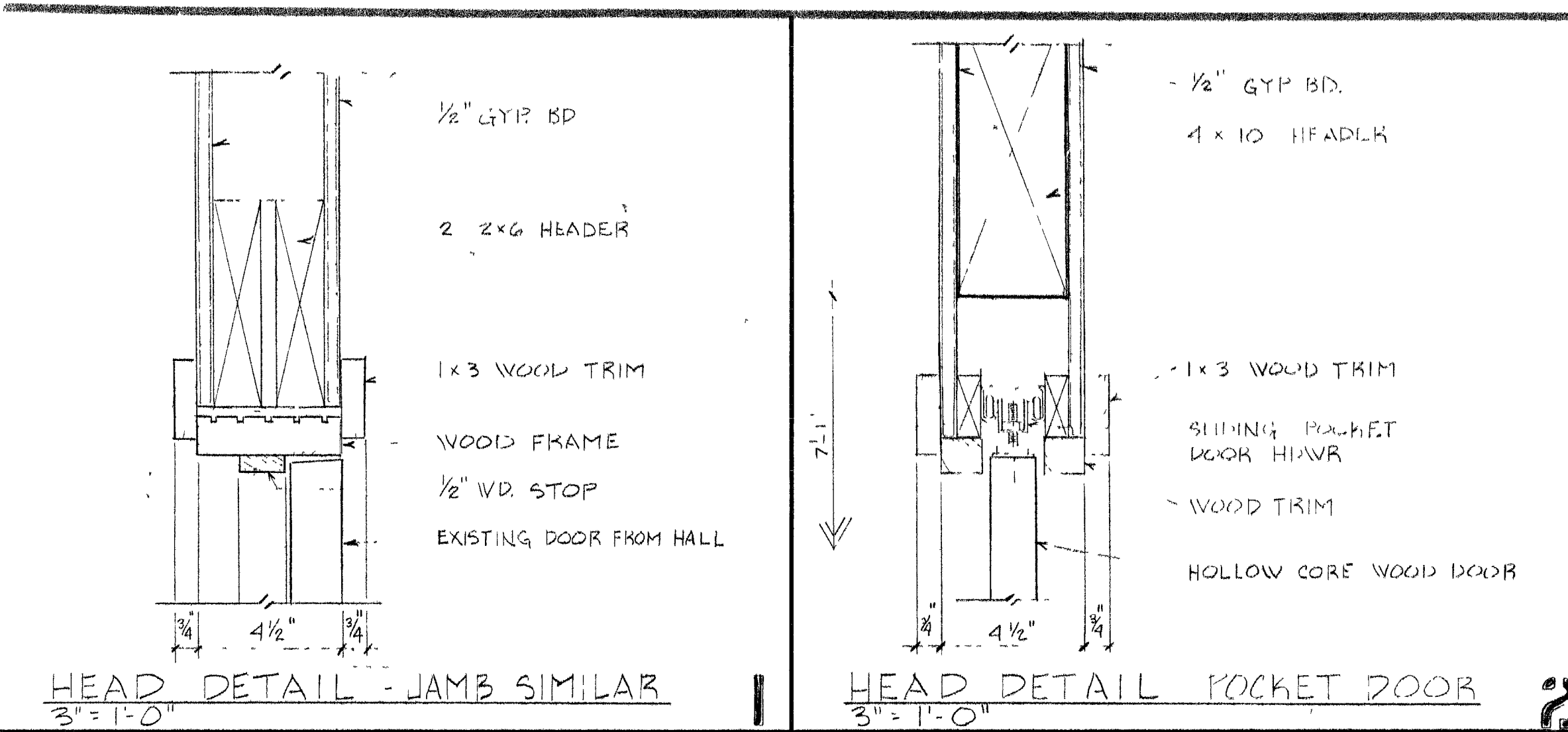

## DOOR SCHEDULE & DOOR TYPES

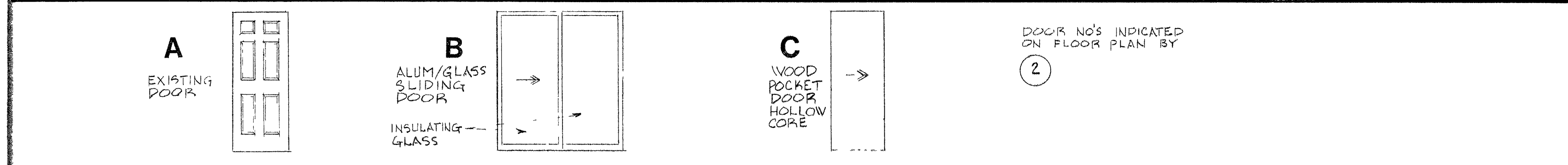

DR NO	TYPE	SIZE	DOORS			FRAMES						REMARKS		
			MAT'L.	GLASS	LOUVER	HEAD	JAMB	SILL	MULL.	TRAN.	LABEL		MAT'L.	
2	A	EXISTING	WOOD	EXIST										DOOR TAKEN FROM HALL - CHECK DOOR SIZE
3	A	EXISTING	WOOD	EXIST										DOOR TAKEN FROM HALL - CHECK DOOR SIZE
4	B	2'6\"/>												

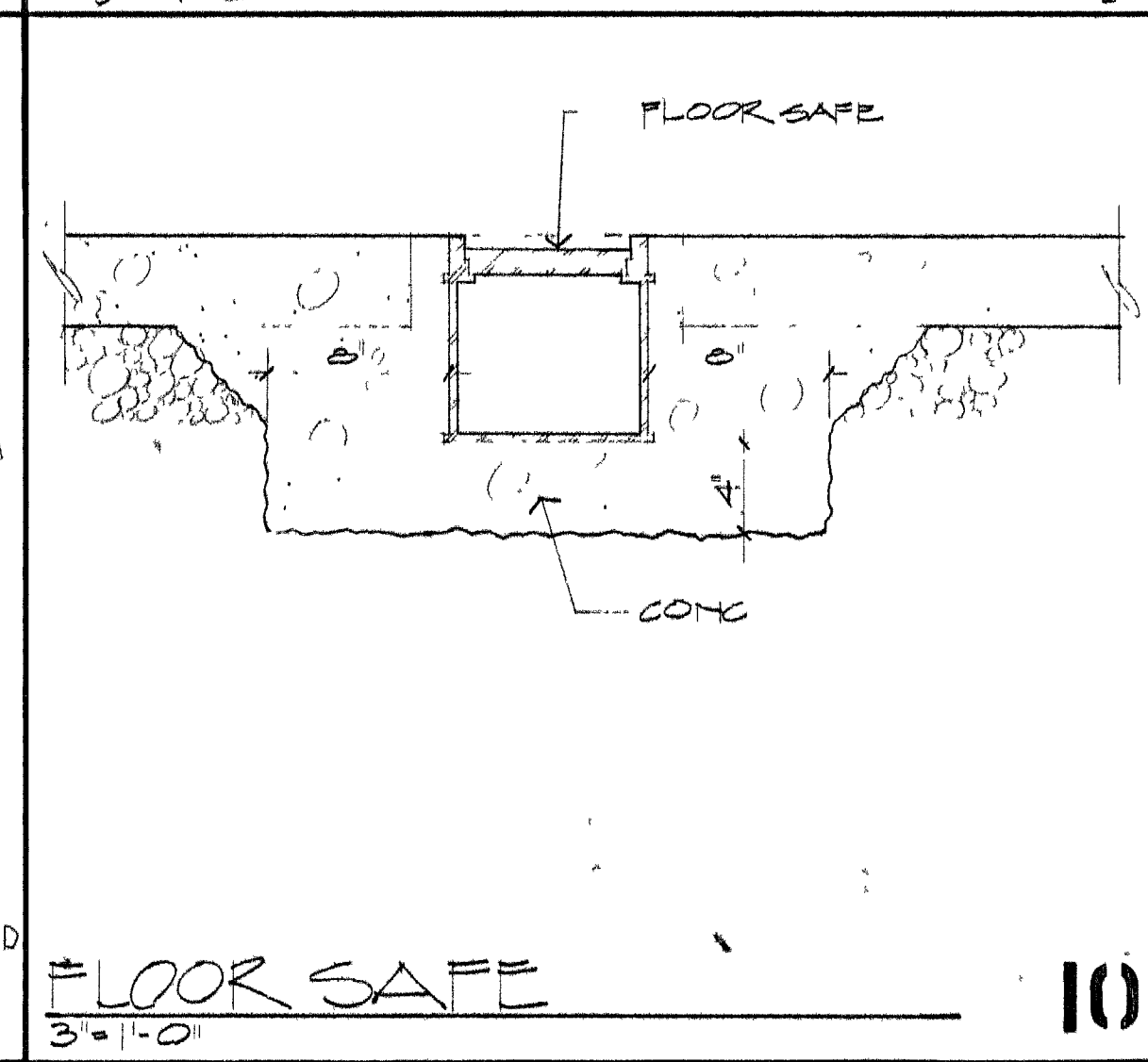
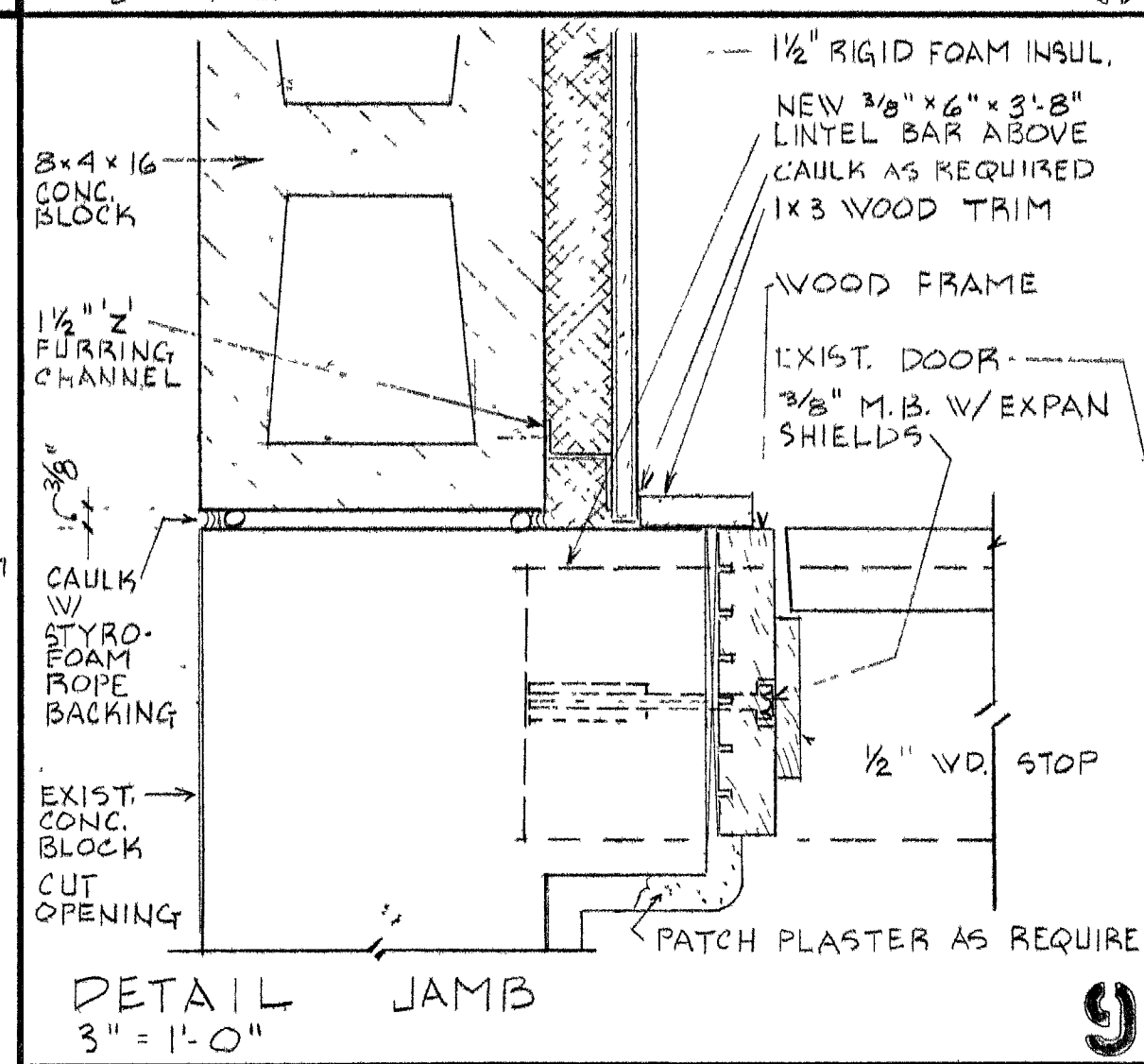
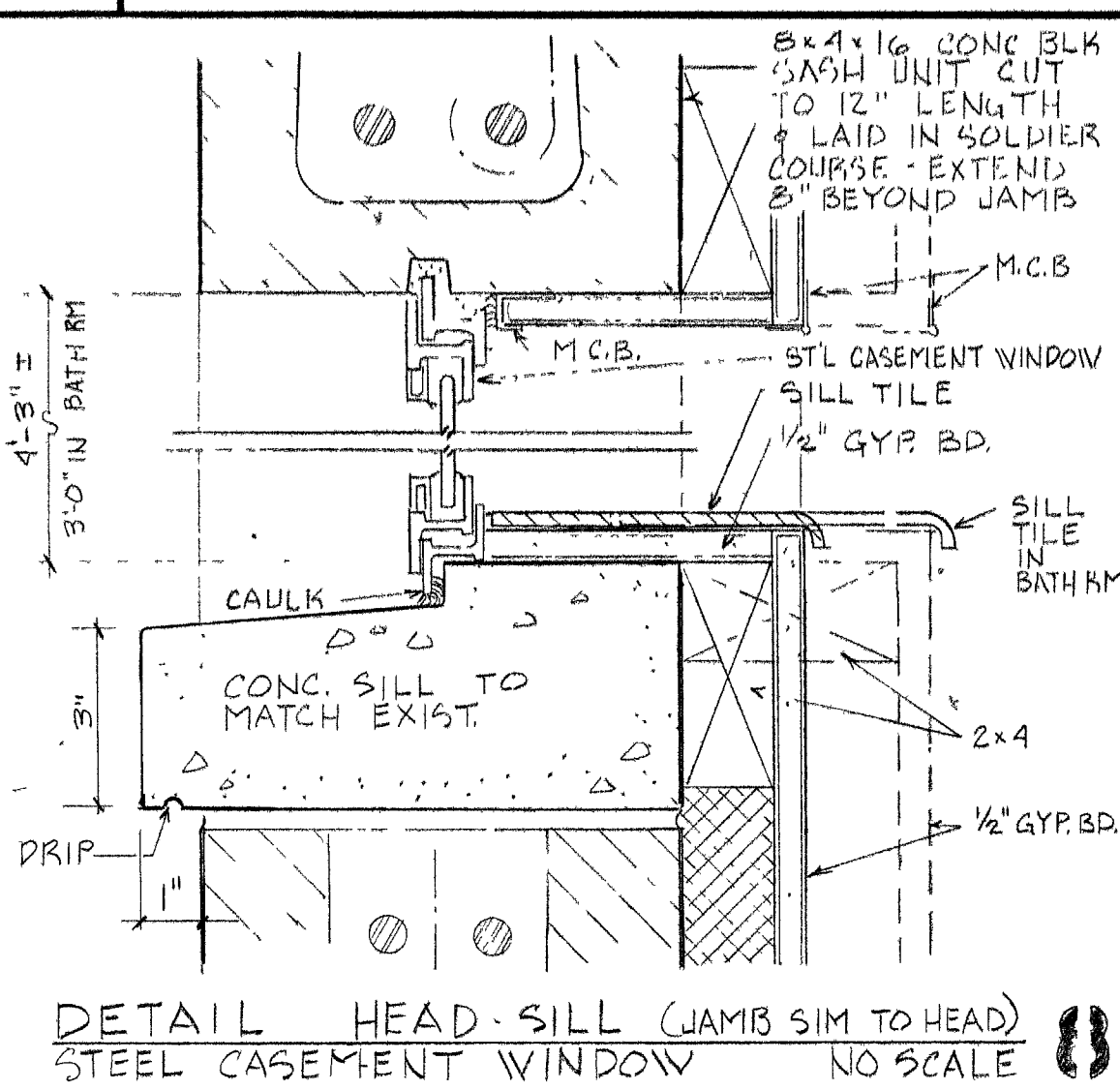
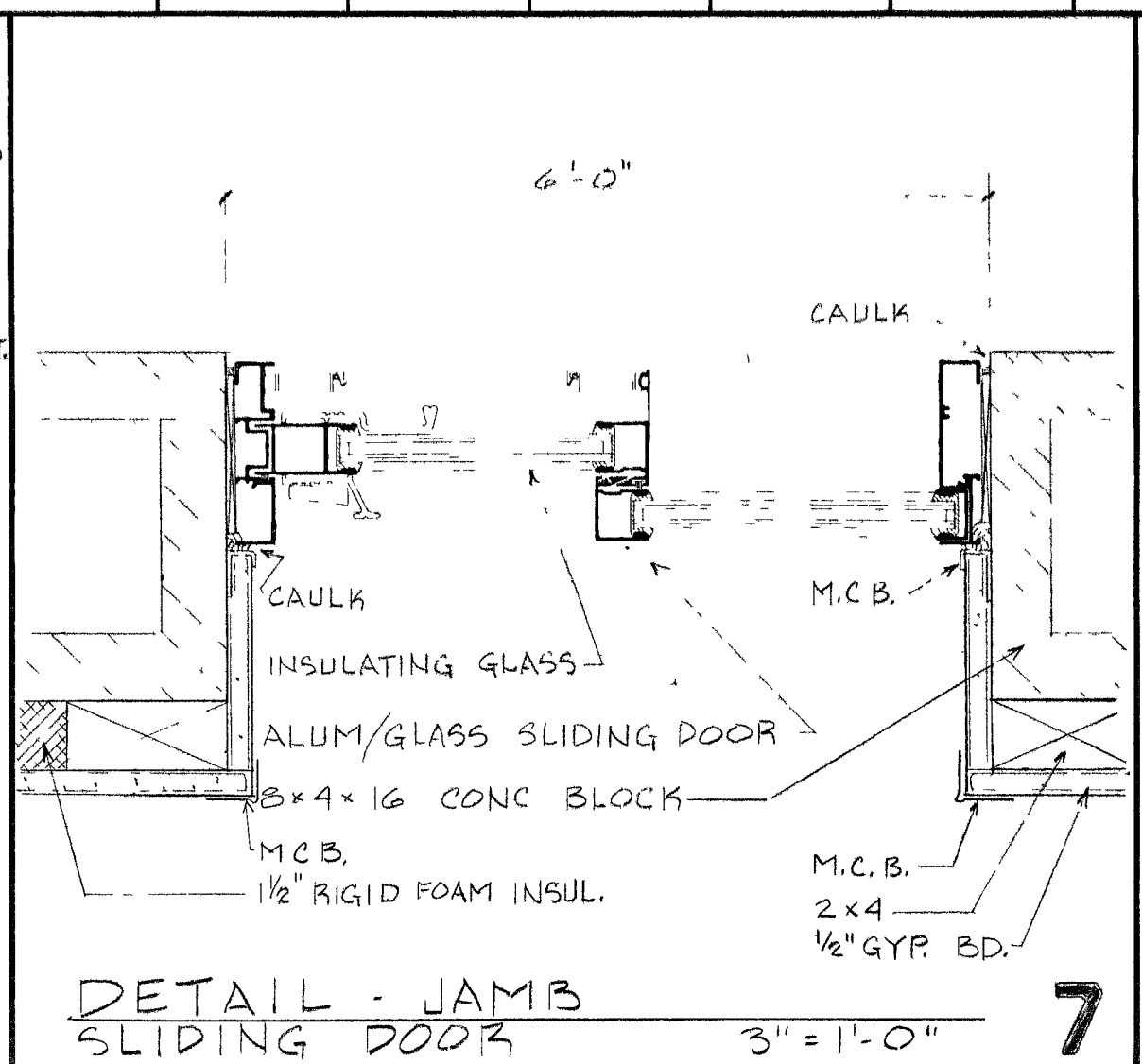
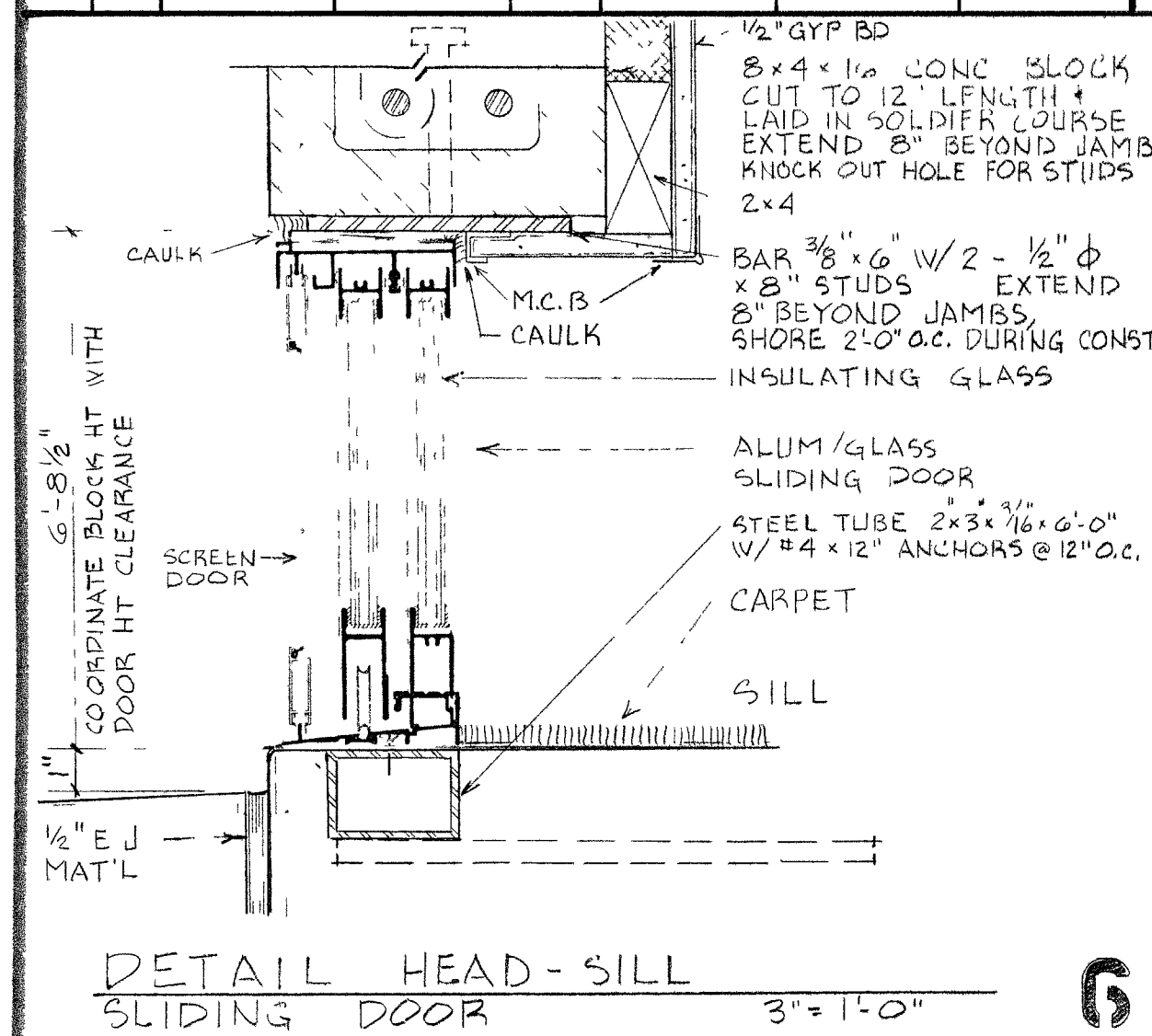
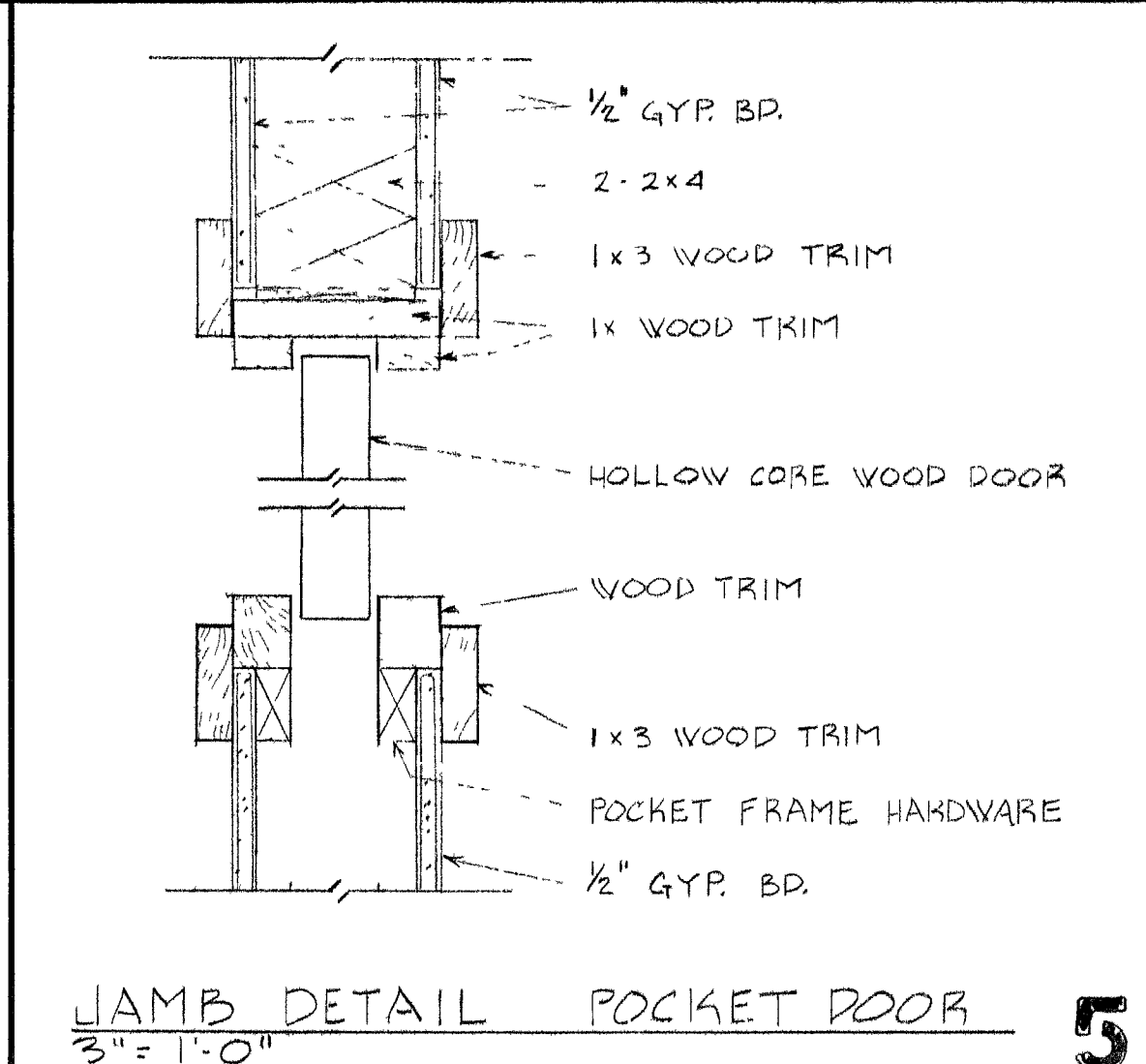
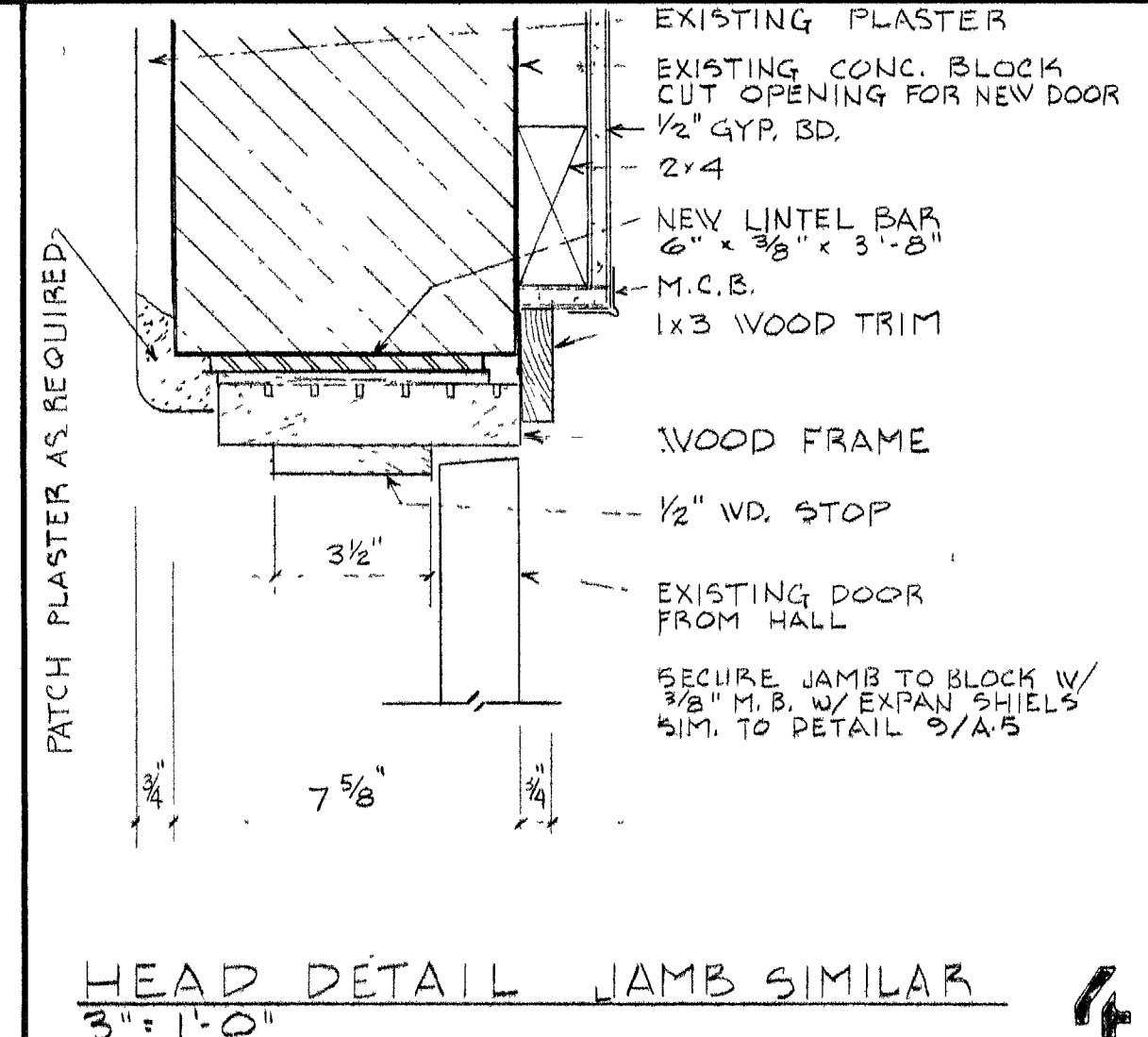
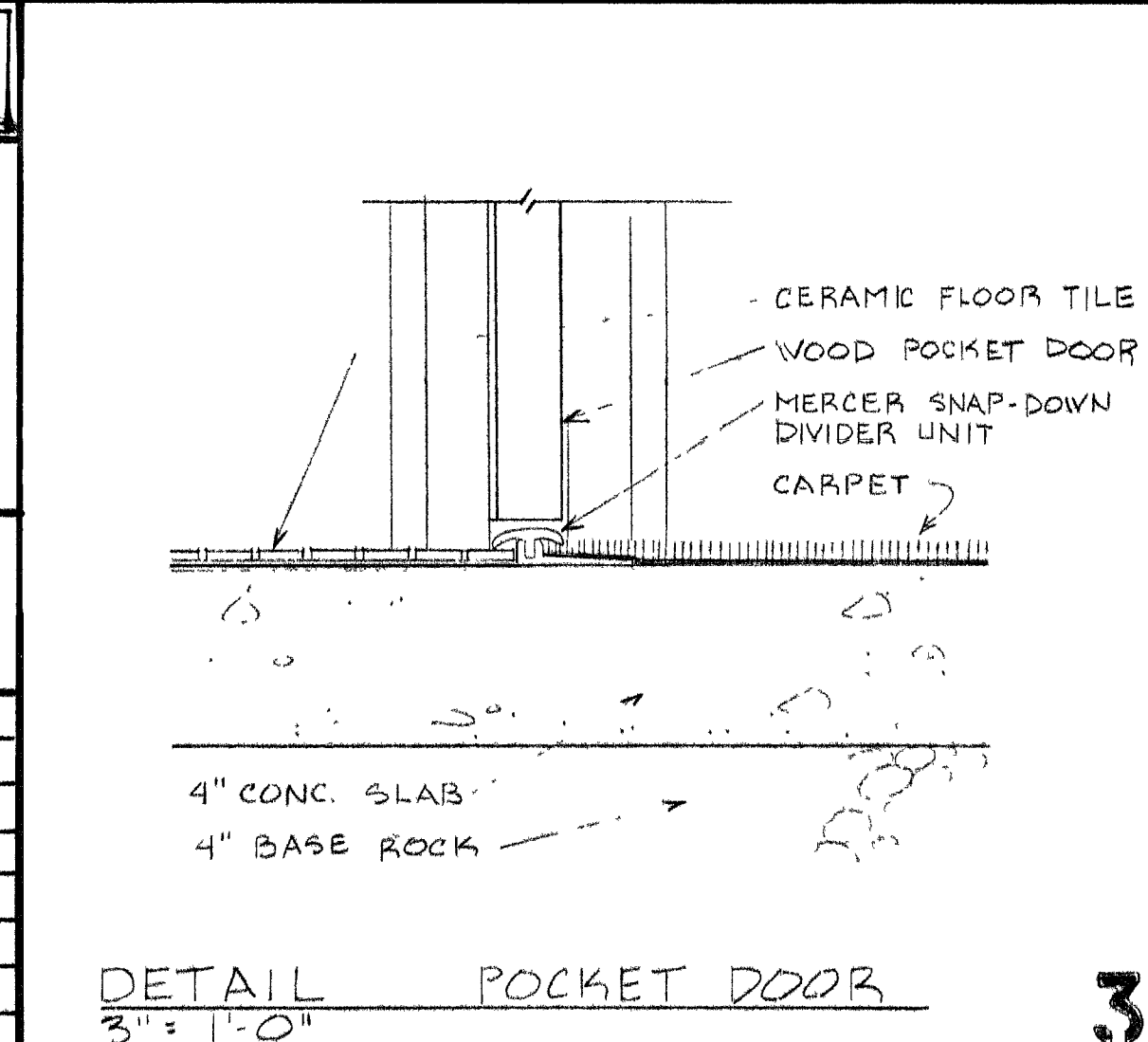

CHARLES SALADINO-LANDSCAPE ARCHITECT-ASLA-LTD  
**RANGER'S RESIDENCE - SCHEDULES & DETAILS**  
 FLOYD LAMB STATE PARK 1" TULE SPRINGS LAS VEGAS, NEVADA PHASE 1-B & 2  
 1395 HASKELL ST. - SUITE C - RENO, NEVADA - 89509-702-786-2560  
 VDAY & FERRARI LTD.  
 1000 W. HARRIS ST. RENO, NEV.  
 757-831-2222

