

SECTION @ SNACK BAR - SECTION A-A
 VERT.: 1/4"=1'-0" HORIZ.: 1/8"=1'-0"

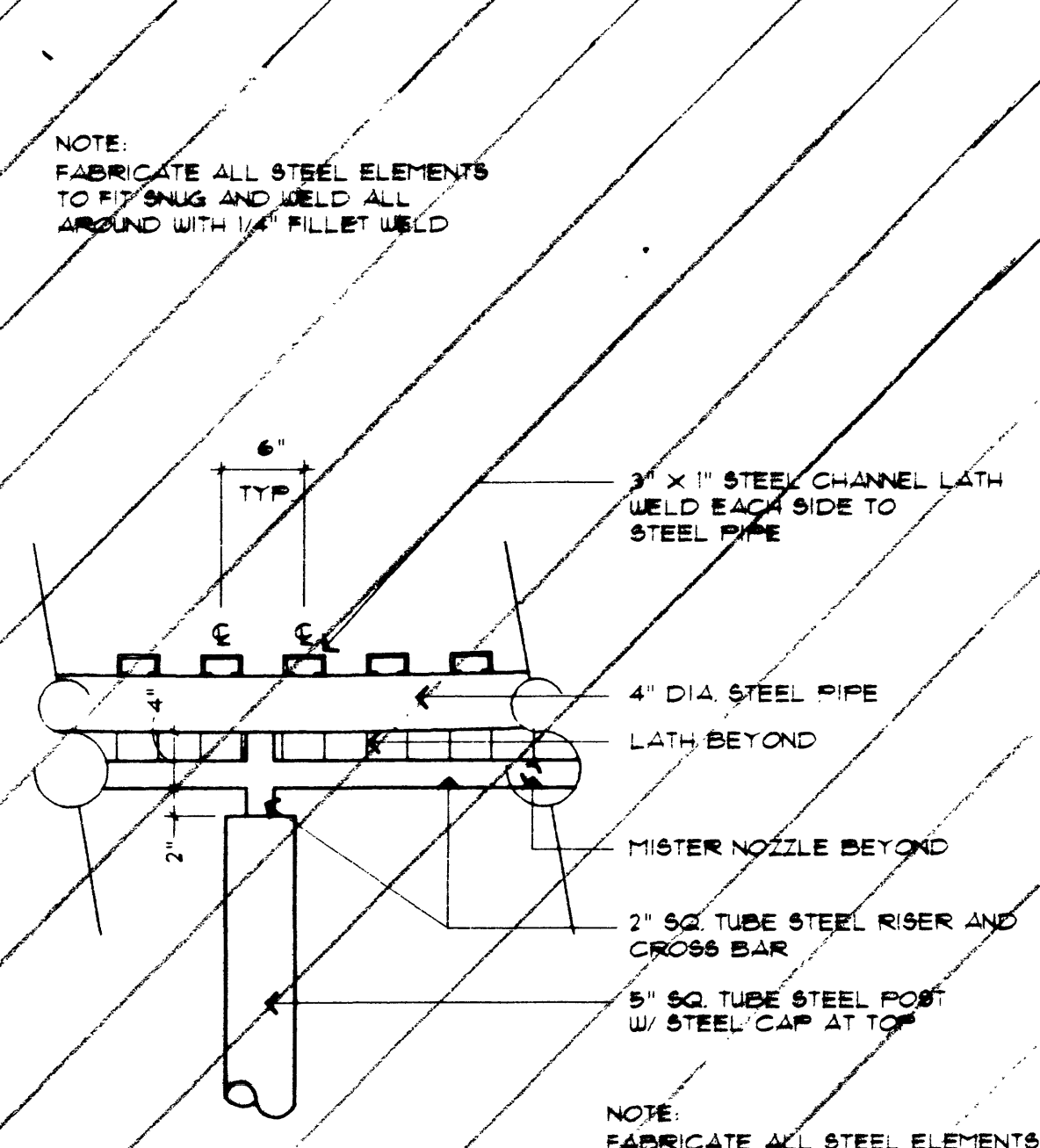

POST TO ROOF-LOW POINT
 SCALE: 1"=1'-0"

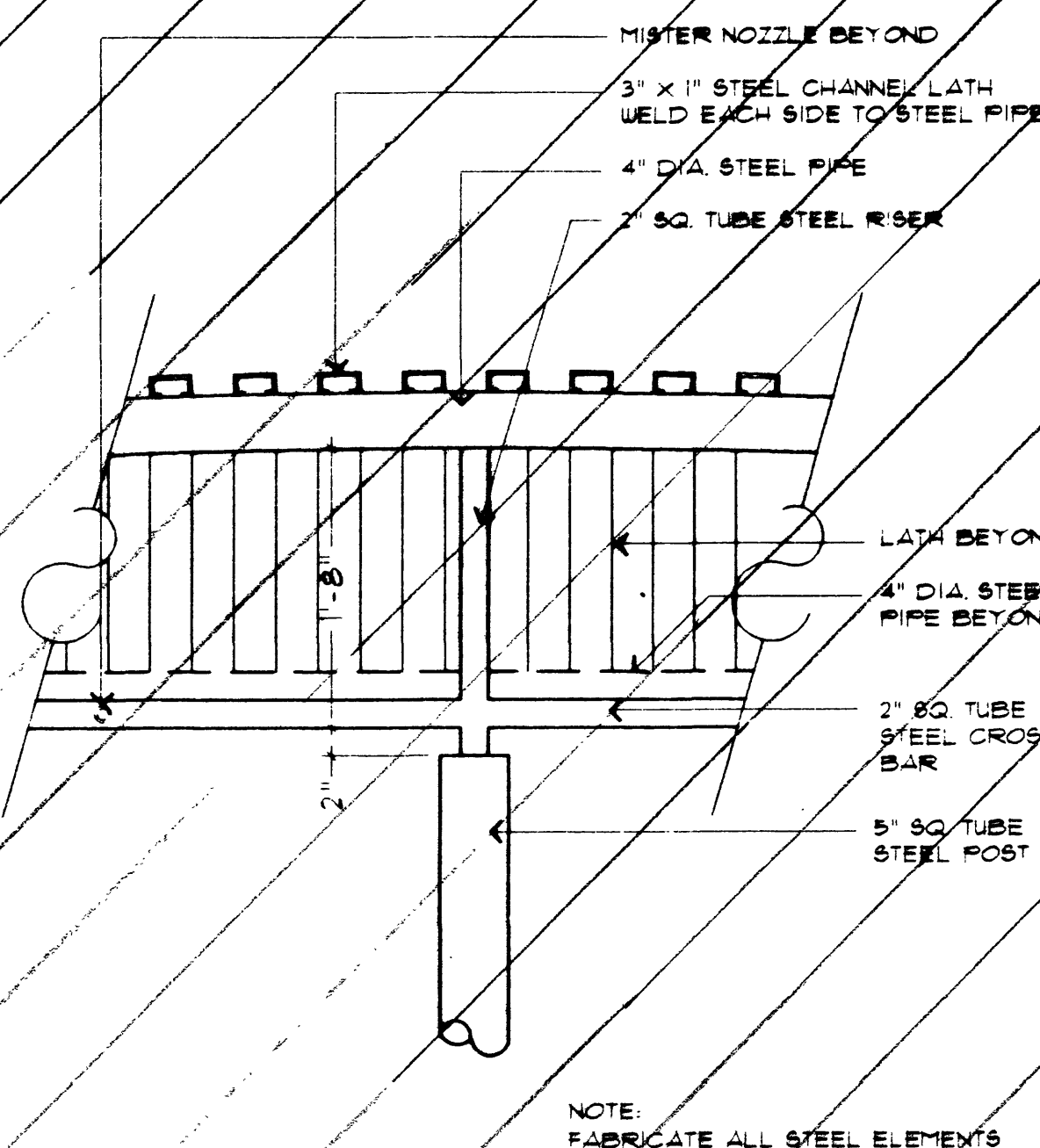

POST TO ROOF-HIGH POINT
 SCALE: 1"=1'-0"

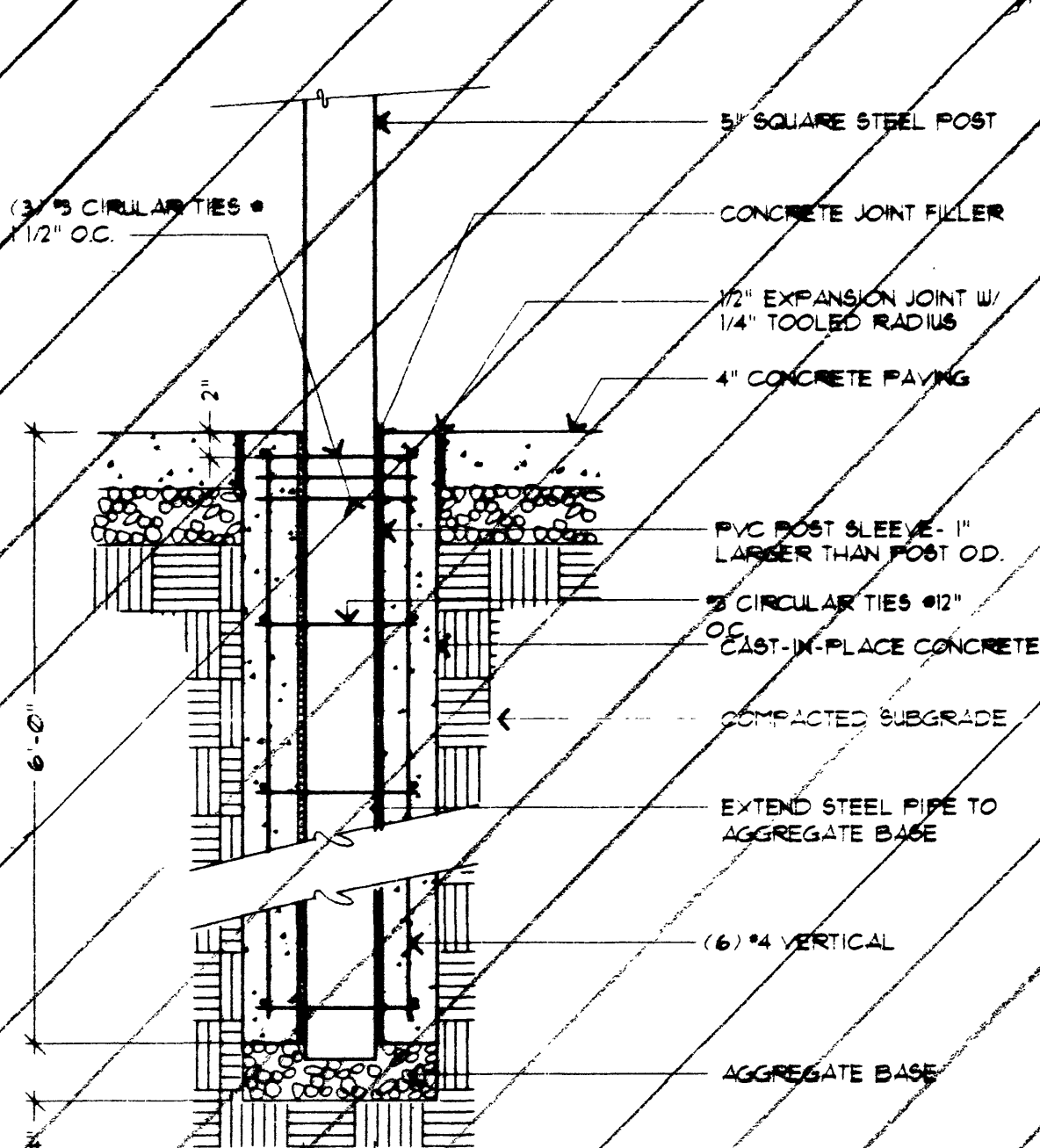

SHADE STRUCTURE POST FTG
 SCALE: 1"=1'-0"

NOT A PART

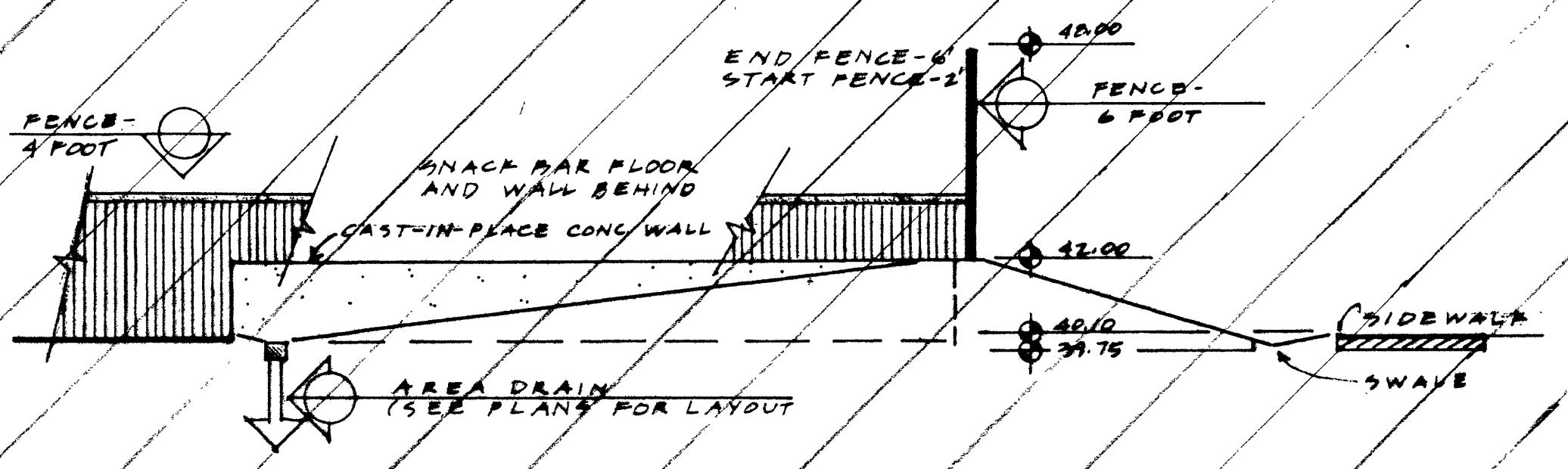

SECTION AT SOUTH END OF SNACK BAR-SECTION B-B
 VERT.: 1/4"=1'-0" HORIZ.: 1/8"=1'-0"

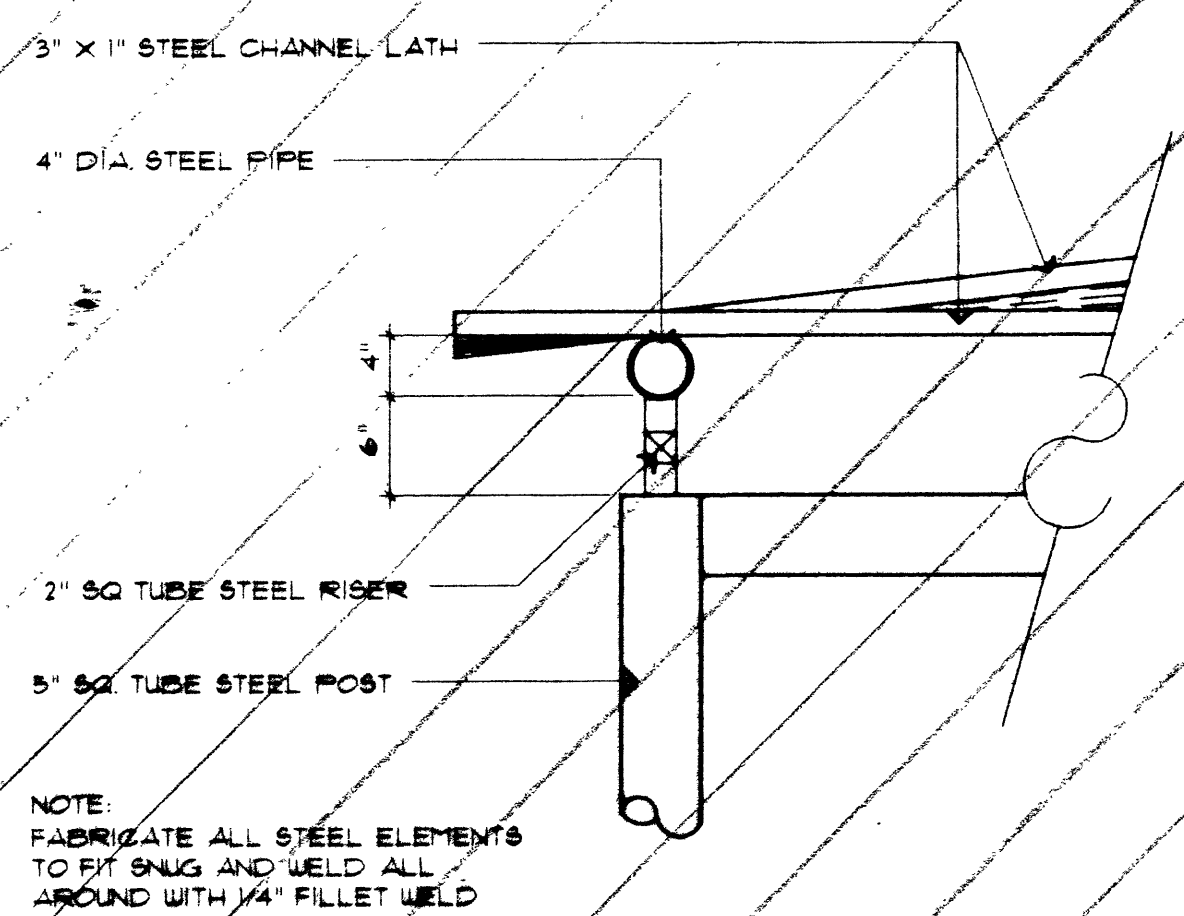

POST TO ROOF-BACK
 SCALE: 1"=1'-0"

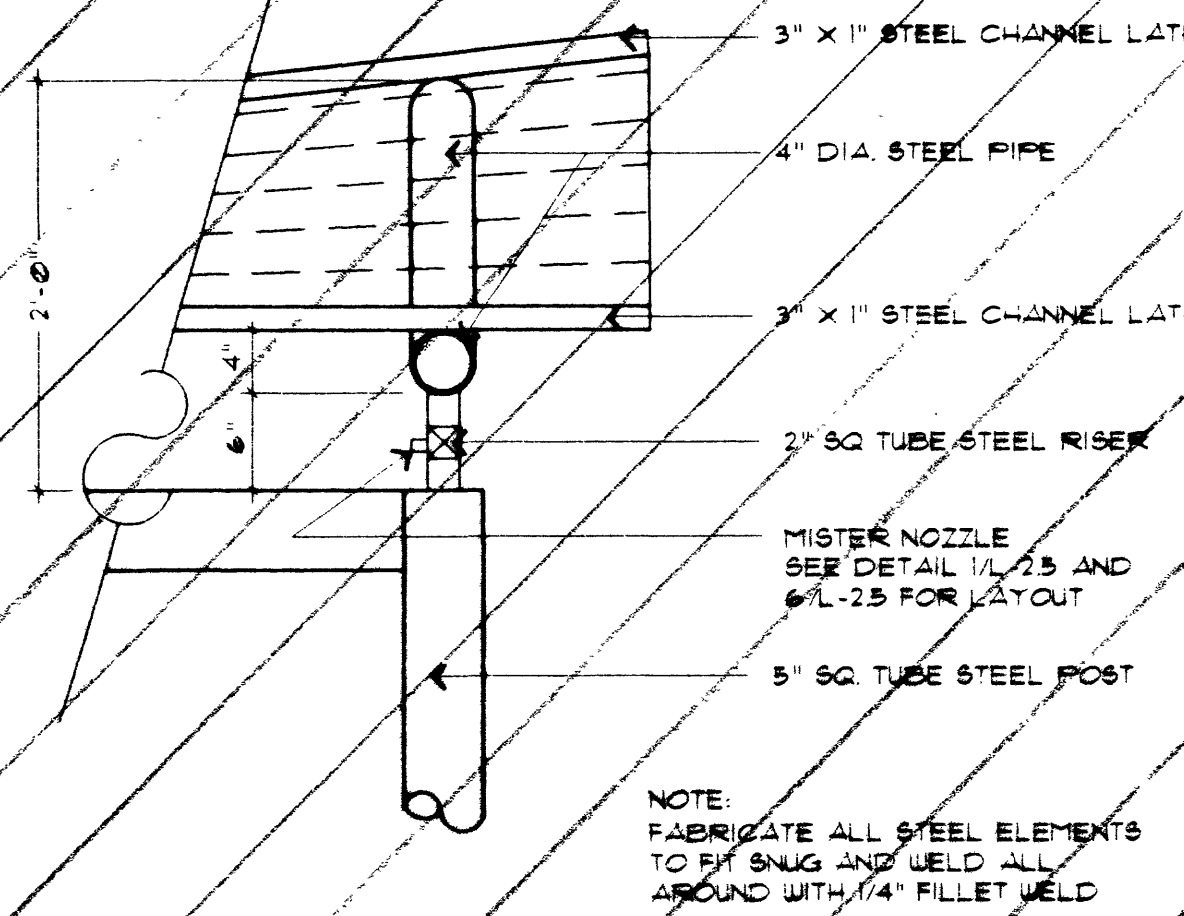

POST TO ROOF-FRONT
 NTS

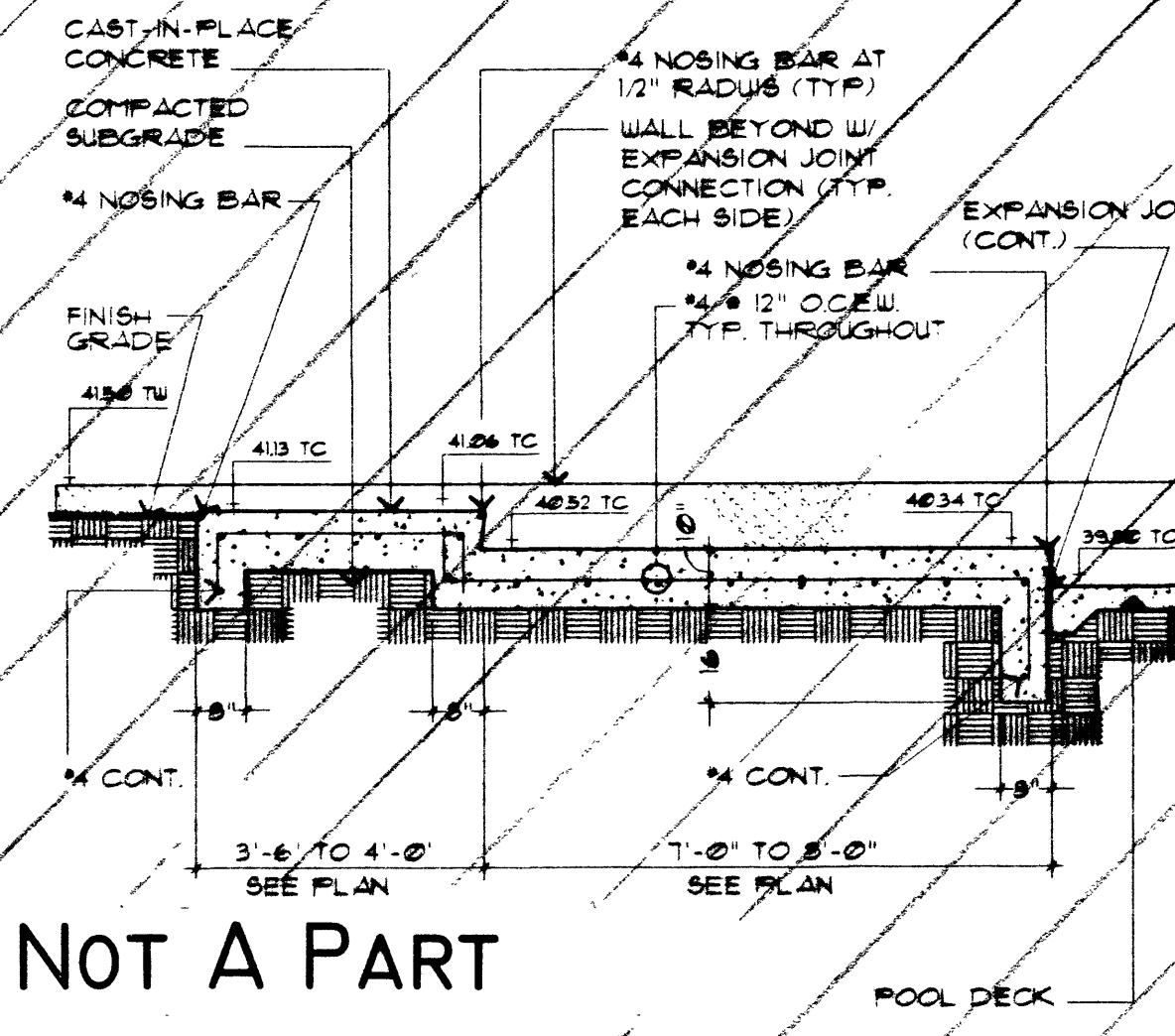

SECTION AT CONC. TERRACE
 SCALE: 3/8"=1'-0"

NOT A PART

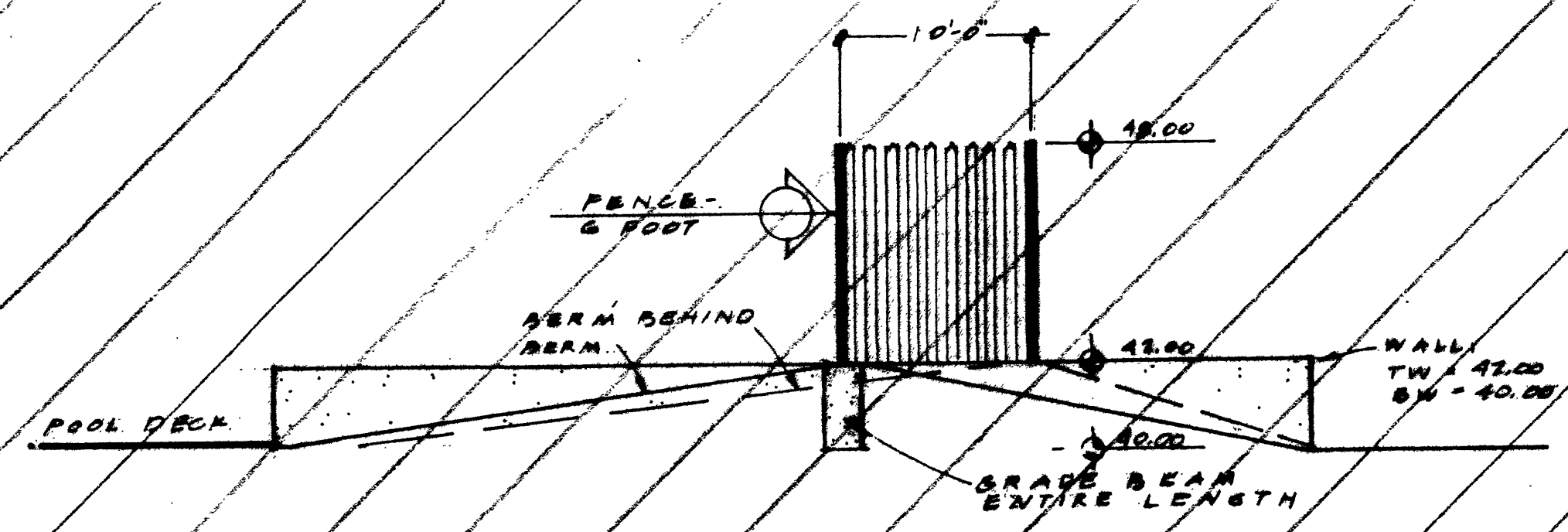

POOL AREA AT SOUTHEAST-SECTION C-C
 VERT.: 1/4"=1'-0" HORIZ.: 1/8"=1'-0"

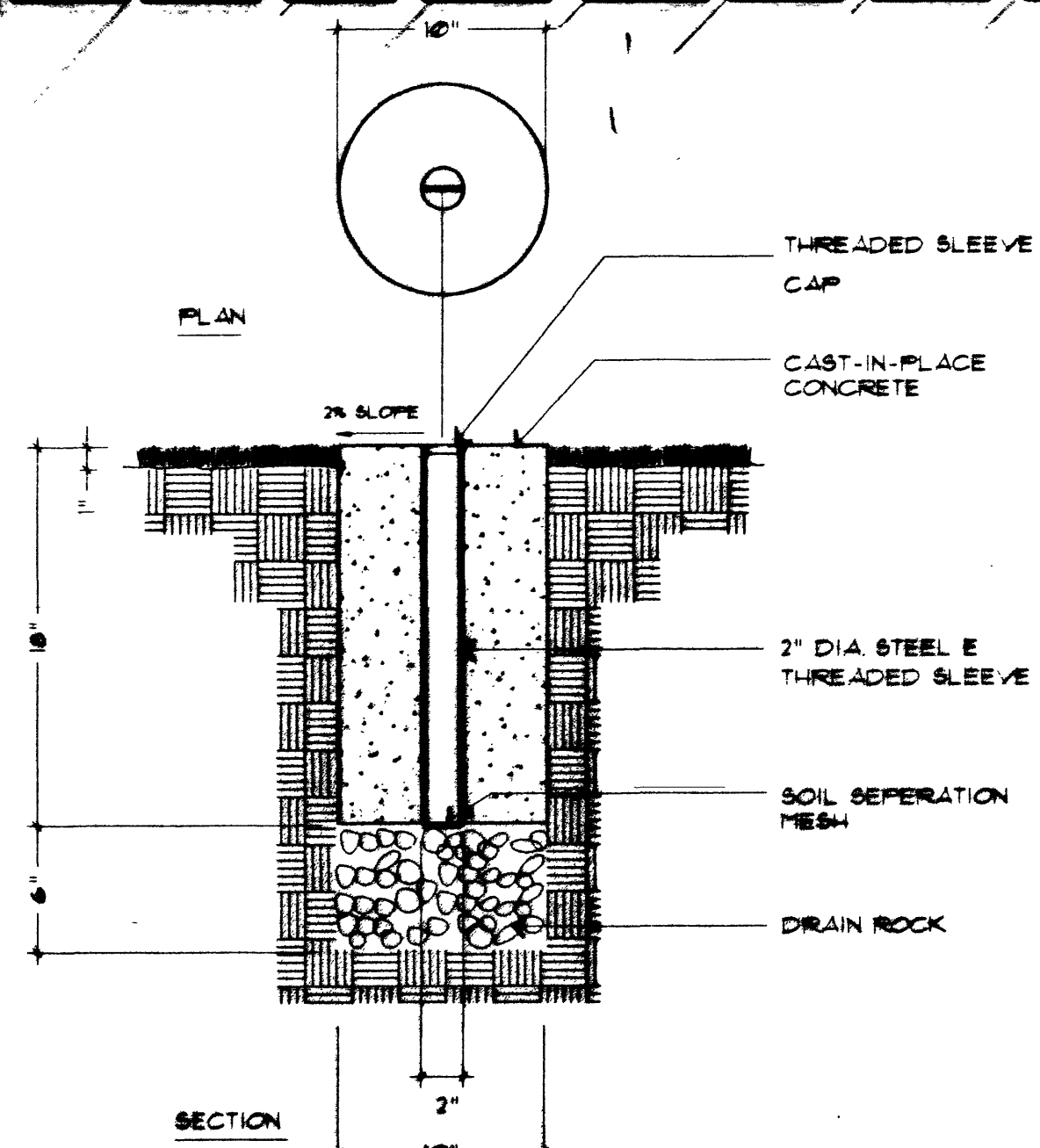

UMBRELLA SLEEVE IN LAWN
 SCALE: 3/4"=1'-0"

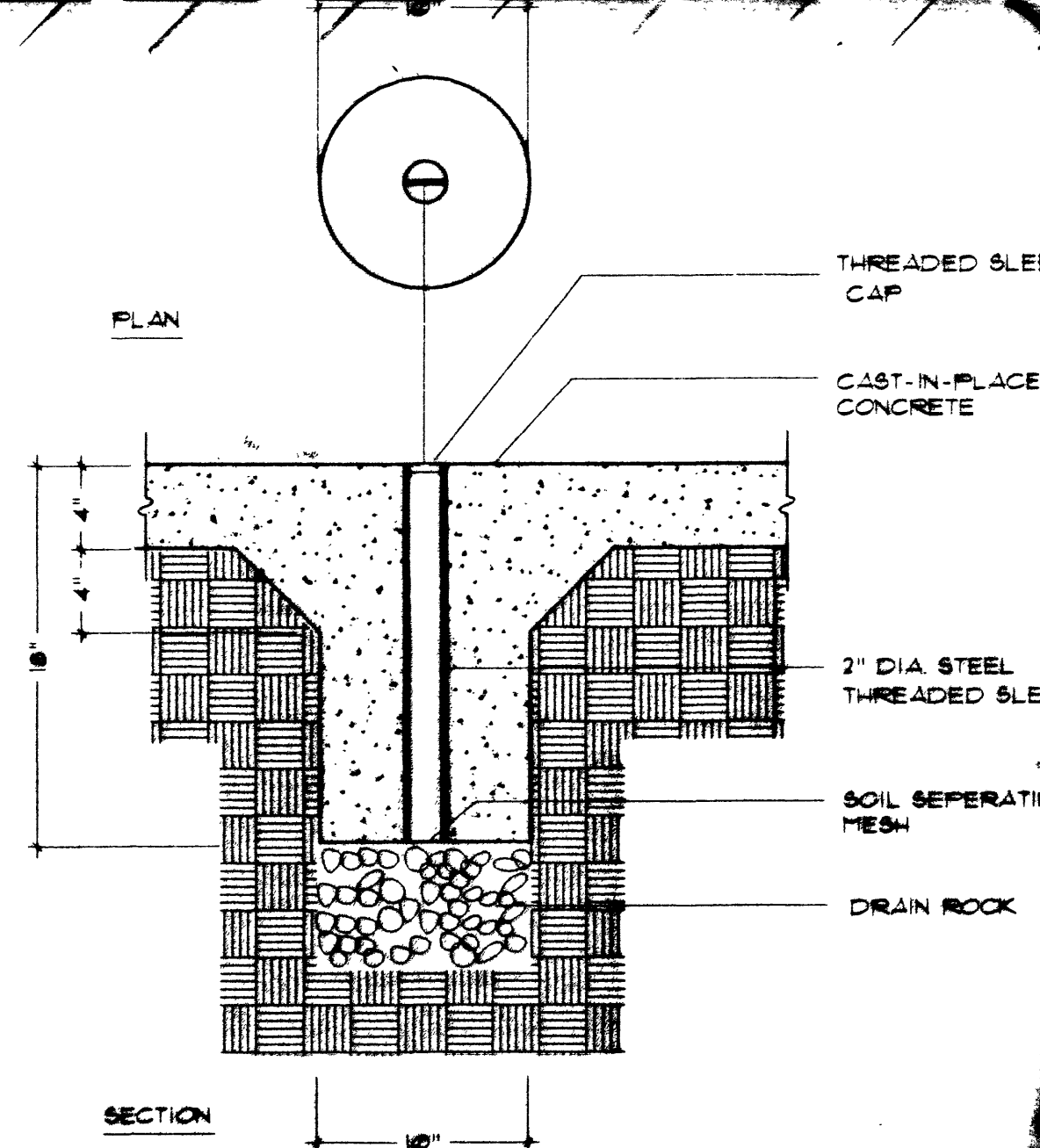

UMBRELLA SLEEVE IN CONC.
 SCALE: 3/4"=1'-0"

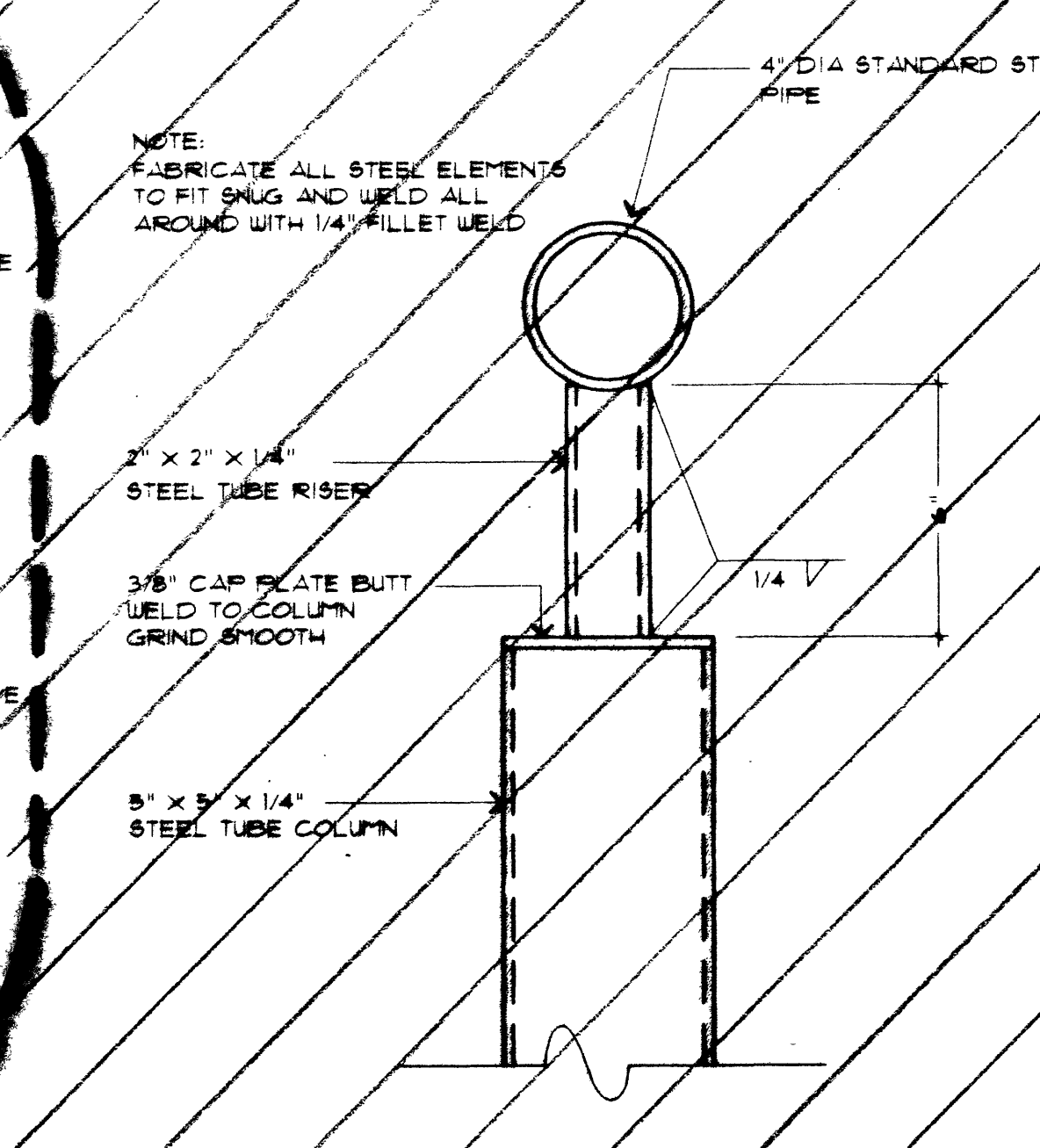

POST TO ROOF CONNECTION
 SCALE: 3/8"=1'-0"