

DESIGNED BY: DRG	DRAWN BY: DRG	DATE: 3/97
CHECKED BY:	JOB NUMBER: 001-700X	BY DATE
NO.	REVISION	

WATT HOMES - NEVADA DIVISION  
 ELKHORN SPRINGS - PARCEL 2  
 UNIT 2 - SHADY GLEN AVENUE

ORION ENGINEERING AND SURVEYING, INC.  
 2700 CHANDLER AVENUE, SUITE B-1  
 LAS VEGAS, NEVADA 89120  
 (702) 739-5921 FAX (702) 739-5929

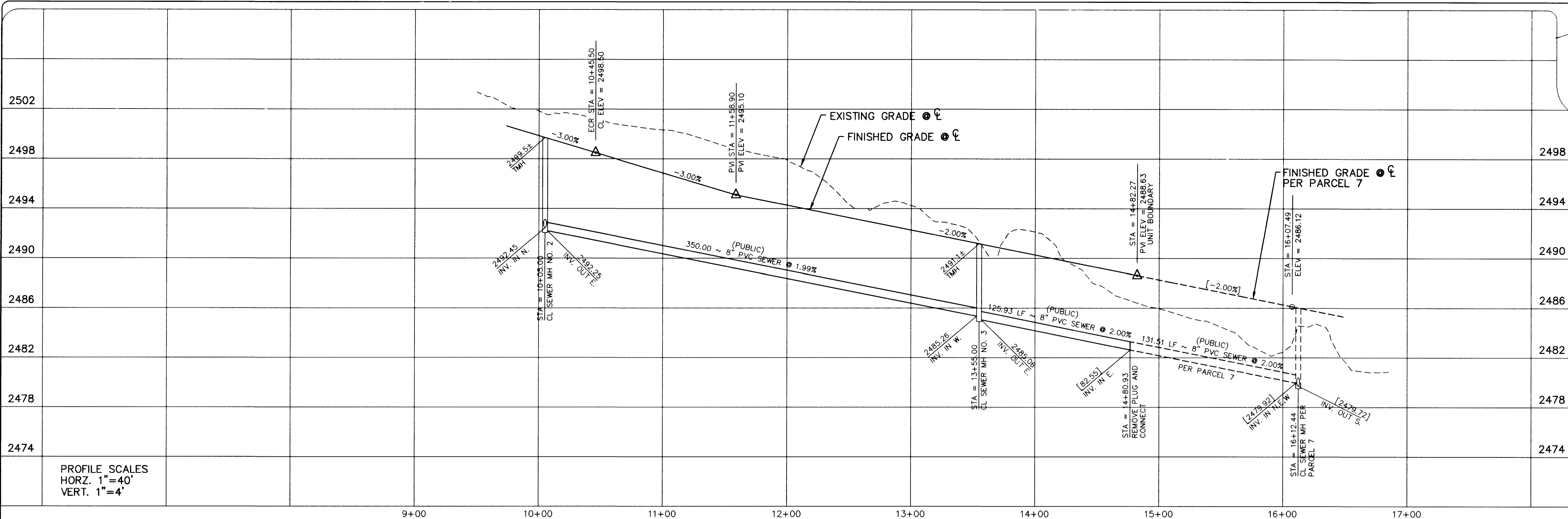
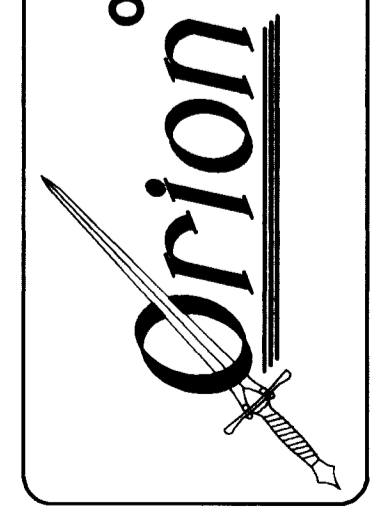

CURVE DATA - CENTERLINE

CURVE	RADIUS	LENGTH	TANGENT	DELTA
C4	45.50'	71.47'	45.50'	90°00'00"

CURVE DATA - BACK OF CURB

CURVE	RADIUS	LENGTH	TANGENT	DELTA
C1	25.00'	39.27'	25.00'	90°00'00"
C2	25.00'	14.99'	7.73'	34°21'09"
C3	61.00'	168.97'	324.46'	158°42'18"

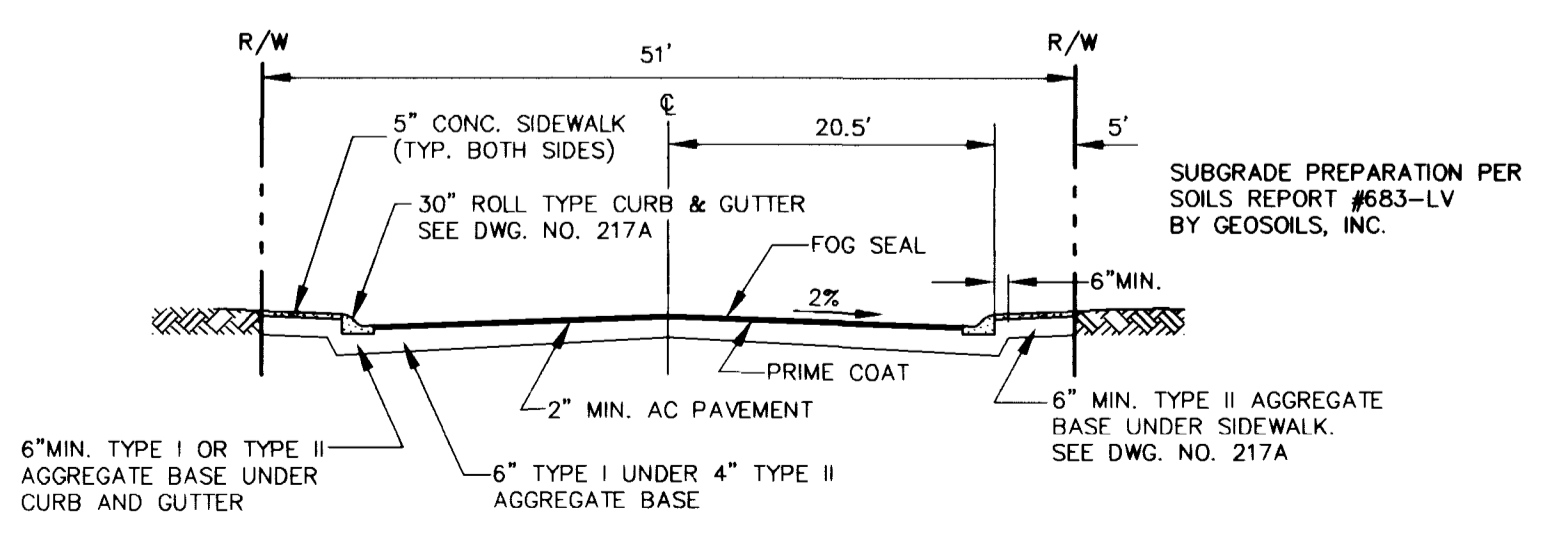
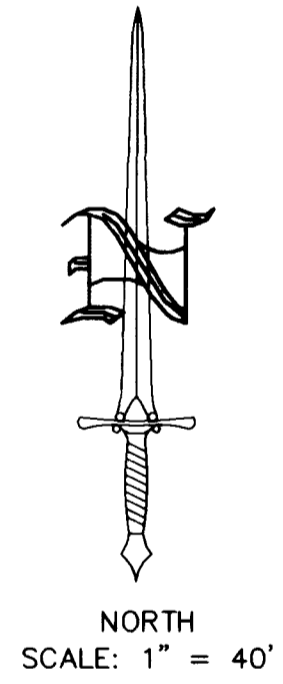
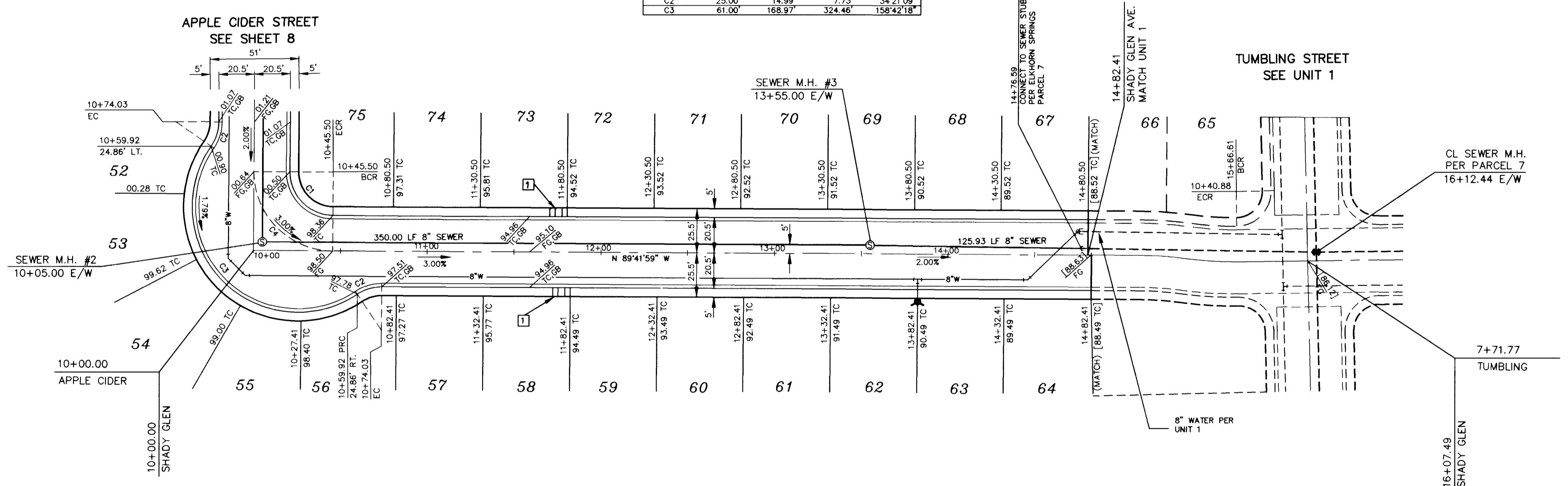
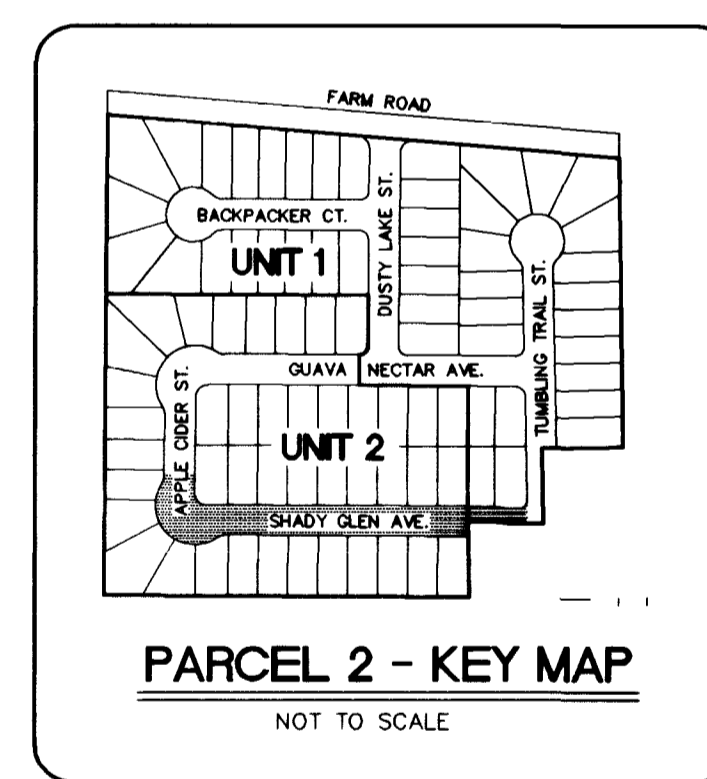

CONSTRUCTION NOTE:  
 [ ] CONSTRUCT CASE 1 SIDEWALK RAMP PER STD. DWG. NO. 235  
 A = 8', B = 8'

Avoid overhead power line contact.  
**Call before you Overhead**  
 1-702-593-6111  
 NEVADA POWER ENVIRONMENT AND SAFETY SERVICES DEPARTMENT

Avoid cutting underground utility lines. It's costly.  
**Call before you Dig.**  
 1-800-227-2600  
 UNDERGROUND SERVICE ALERT (USA)

# SHADY GLEN AVENUE

## PUBLIC

TYP. STREET CROSS-SECTION (51' R/W)  
 NO SCALE STD. DWG. No. 207

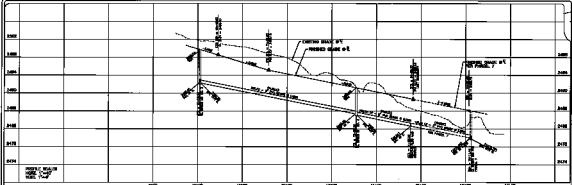

DATE: 10/1/01  
 DRAWN BY: J. J. JONES

SYMBOL	DESCRIPTION
(Symbol)	12" DIA. MANHOLE
(Symbol)	18" DIA. MANHOLE
(Symbol)	24" DIA. MANHOLE
(Symbol)	30" DIA. MANHOLE
(Symbol)	36" DIA. MANHOLE
(Symbol)	42" DIA. MANHOLE
(Symbol)	48" DIA. MANHOLE
(Symbol)	54" DIA. MANHOLE
(Symbol)	60" DIA. MANHOLE
(Symbol)	66" DIA. MANHOLE
(Symbol)	72" DIA. MANHOLE
(Symbol)	78" DIA. MANHOLE
(Symbol)	84" DIA. MANHOLE
(Symbol)	90" DIA. MANHOLE
(Symbol)	96" DIA. MANHOLE
(Symbol)	102" DIA. MANHOLE
(Symbol)	108" DIA. MANHOLE
(Symbol)	114" DIA. MANHOLE
(Symbol)	120" DIA. MANHOLE
(Symbol)	126" DIA. MANHOLE
(Symbol)	132" DIA. MANHOLE
(Symbol)	138" DIA. MANHOLE
(Symbol)	144" DIA. MANHOLE
(Symbol)	150" DIA. MANHOLE
(Symbol)	156" DIA. MANHOLE
(Symbol)	162" DIA. MANHOLE
(Symbol)	168" DIA. MANHOLE
(Symbol)	174" DIA. MANHOLE
(Symbol)	180" DIA. MANHOLE
(Symbol)	186" DIA. MANHOLE
(Symbol)	192" DIA. MANHOLE
(Symbol)	198" DIA. MANHOLE
(Symbol)	204" DIA. MANHOLE
(Symbol)	210" DIA. MANHOLE
(Symbol)	216" DIA. MANHOLE
(Symbol)	222" DIA. MANHOLE
(Symbol)	228" DIA. MANHOLE
(Symbol)	234" DIA. MANHOLE
(Symbol)	240" DIA. MANHOLE
(Symbol)	246" DIA. MANHOLE
(Symbol)	252" DIA. MANHOLE
(Symbol)	258" DIA. MANHOLE
(Symbol)	264" DIA. MANHOLE
(Symbol)	270" DIA. MANHOLE
(Symbol)	276" DIA. MANHOLE
(Symbol)	282" DIA. MANHOLE
(Symbol)	288" DIA. MANHOLE
(Symbol)	294" DIA. MANHOLE
(Symbol)	300" DIA. MANHOLE
(Symbol)	306" DIA. MANHOLE
(Symbol)	312" DIA. MANHOLE
(Symbol)	318" DIA. MANHOLE
(Symbol)	324" DIA. MANHOLE
(Symbol)	330" DIA. MANHOLE
(Symbol)	336" DIA. MANHOLE
(Symbol)	342" DIA. MANHOLE
(Symbol)	348" DIA. MANHOLE
(Symbol)	354" DIA. MANHOLE
(Symbol)	360" DIA. MANHOLE
(Symbol)	366" DIA. MANHOLE
(Symbol)	372" DIA. MANHOLE
(Symbol)	378" DIA. MANHOLE
(Symbol)	384" DIA. MANHOLE
(Symbol)	390" DIA. MANHOLE
(Symbol)	396" DIA. MANHOLE
(Symbol)	402" DIA. MANHOLE
(Symbol)	408" DIA. MANHOLE
(Symbol)	414" DIA. MANHOLE
(Symbol)	420" DIA. MANHOLE
(Symbol)	426" DIA. MANHOLE
(Symbol)	432" DIA. MANHOLE
(Symbol)	438" DIA. MANHOLE
(Symbol)	444" DIA. MANHOLE
(Symbol)	450" DIA. MANHOLE
(Symbol)	456" DIA. MANHOLE
(Symbol)	462" DIA. MANHOLE
(Symbol)	468" DIA. MANHOLE
(Symbol)	474" DIA. MANHOLE
(Symbol)	480" DIA. MANHOLE
(Symbol)	486" DIA. MANHOLE
(Symbol)	492" DIA. MANHOLE
(Symbol)	498" DIA. MANHOLE
(Symbol)	504" DIA. MANHOLE
(Symbol)	510" DIA. MANHOLE
(Symbol)	516" DIA. MANHOLE
(Symbol)	522" DIA. MANHOLE
(Symbol)	528" DIA. MANHOLE
(Symbol)	534" DIA. MANHOLE
(Symbol)	540" DIA. MANHOLE
(Symbol)	546" DIA. MANHOLE
(Symbol)	552" DIA. MANHOLE
(Symbol)	558" DIA. MANHOLE
(Symbol)	564" DIA. MANHOLE
(Symbol)	570" DIA. MANHOLE
(Symbol)	576" DIA. MANHOLE
(Symbol)	582" DIA. MANHOLE
(Symbol)	588" DIA. MANHOLE
(Symbol)	594" DIA. MANHOLE
(Symbol)	600" DIA. MANHOLE
(Symbol)	606" DIA. MANHOLE
(Symbol)	612" DIA. MANHOLE
(Symbol)	618" DIA. MANHOLE
(Symbol)	624" DIA. MANHOLE
(Symbol)	630" DIA. MANHOLE
(Symbol)	636" DIA. MANHOLE
(Symbol)	642" DIA. MANHOLE
(Symbol)	648" DIA. MANHOLE
(Symbol)	654" DIA. MANHOLE
(Symbol)	660" DIA. MANHOLE
(Symbol)	666" DIA. MANHOLE
(Symbol)	672" DIA. MANHOLE
(Symbol)	678" DIA. MANHOLE
(Symbol)	684" DIA. MANHOLE
(Symbol)	690" DIA. MANHOLE
(Symbol)	696" DIA. MANHOLE
(Symbol)	702" DIA. MANHOLE
(Symbol)	708" DIA. MANHOLE
(Symbol)	714" DIA. MANHOLE
(Symbol)	720" DIA. MANHOLE
(Symbol)	726" DIA. MANHOLE
(Symbol)	732" DIA. MANHOLE
(Symbol)	738" DIA. MANHOLE
(Symbol)	744" DIA. MANHOLE
(Symbol)	750" DIA. MANHOLE
(Symbol)	756" DIA. MANHOLE
(Symbol)	762" DIA. MANHOLE
(Symbol)	768" DIA. MANHOLE
(Symbol)	774" DIA. MANHOLE
(Symbol)	780" DIA. MANHOLE
(Symbol)	786" DIA. MANHOLE
(Symbol)	792" DIA. MANHOLE
(Symbol)	798" DIA. MANHOLE
(Symbol)	804" DIA. MANHOLE
(Symbol)	810" DIA. MANHOLE
(Symbol)	816" DIA. MANHOLE
(Symbol)	822" DIA. MANHOLE
(Symbol)	828" DIA. MANHOLE
(Symbol)	834" DIA. MANHOLE
(Symbol)	840" DIA. MANHOLE
(Symbol)	846" DIA. MANHOLE
(Symbol)	852" DIA. MANHOLE
(Symbol)	858" DIA. MANHOLE
(Symbol)	864" DIA. MANHOLE
(Symbol)	870" DIA. MANHOLE
(Symbol)	876" DIA. MANHOLE
(Symbol)	882" DIA. MANHOLE
(Symbol)	888" DIA. MANHOLE
(Symbol)	894" DIA. MANHOLE
(Symbol)	900" DIA. MANHOLE
(Symbol)	906" DIA. MANHOLE
(Symbol)	912" DIA. MANHOLE
(Symbol)	918" DIA. MANHOLE
(Symbol)	924" DIA. MANHOLE
(Symbol)	930" DIA. MANHOLE
(Symbol)	936" DIA. MANHOLE
(Symbol)	942" DIA. MANHOLE
(Symbol)	948" DIA. MANHOLE
(Symbol)	954" DIA. MANHOLE
(Symbol)	960" DIA. MANHOLE
(Symbol)	966" DIA. MANHOLE
(Symbol)	972" DIA. MANHOLE
(Symbol)	978" DIA. MANHOLE
(Symbol)	984" DIA. MANHOLE
(Symbol)	990" DIA. MANHOLE
(Symbol)	996" DIA. MANHOLE
(Symbol)	1002" DIA. MANHOLE
(Symbol)	1008" DIA. MANHOLE
(Symbol)	1014" DIA. MANHOLE
(Symbol)	1020" DIA. MANHOLE
(Symbol)	1026" DIA. MANHOLE
(Symbol)	1032" DIA. MANHOLE
(Symbol)	1038" DIA. MANHOLE
(Symbol)	1044" DIA. MANHOLE
(Symbol)	1050" DIA. MANHOLE
(Symbol)	1056" DIA. MANHOLE
(Symbol)	1062" DIA. MANHOLE
(Symbol)	1068" DIA. MANHOLE
(Symbol)	1074" DIA. MANHOLE
(Symbol)	1080" DIA. MANHOLE
(Symbol)	1086" DIA. MANHOLE
(Symbol)	1092" DIA. MANHOLE
(Symbol)	1098" DIA. MANHOLE
(Symbol)	1104" DIA. MANHOLE
(Symbol)	1110" DIA. MANHOLE
(Symbol)	1116" DIA. MANHOLE
(Symbol)	1122" DIA. MANHOLE
(Symbol)	1128" DIA. MANHOLE
(Symbol)	1134" DIA. MANHOLE
(Symbol)	1140" DIA. MANHOLE
(Symbol)	1146" DIA. MANHOLE
(Symbol)	1152" DIA. MANHOLE
(Symbol)	1158" DIA. MANHOLE
(Symbol)	1164" DIA. MANHOLE
(Symbol)	1170" DIA. MANHOLE
(Symbol)	1176" DIA. MANHOLE
(Symbol)	1182" DIA. MANHOLE
(Symbol)	1188" DIA. MANHOLE
(Symbol)	1194" DIA. MANHOLE
(Symbol)	1200" DIA. MANHOLE

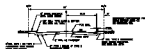
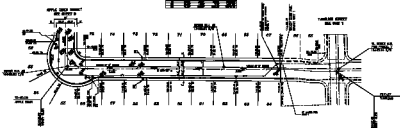

TYP. STREET CROSS-SECTION (10' R/W)  
 SEE SHEET 201-200-01

AMERICAN INCHES  
 1/8" = 1'-0"

# SHADY GLEN AVENUE

## PUBLIC

Call before you Overhead  
 1-708-385-6711

Call before you Dig  
 1-800-327-2803

DATE: 10/1/01
DRAWN BY: J. J. JONES
CHECKED BY: J. J. JONES
APPROVED BY: J. J. JONES
PROJECT NO.: 201-200-01
SHEET NO.: 201-200-01

NOTE: OWNER - METROPOLITAN WATERWORKS & SEWERAGE DEPARTMENT - 1500 N. WASHINGTON ST. - CHICAGO, IL 60610  
 SHEET 2 OF 201-200-01

FOR INFORMATION AND REFERENCE ONLY  
 CALL 1-800-327-2803  
 BEFORE YOU DIG

DATE: 10/1/01  
 SHEET 2 OF 201-200-01