

HEAD
SCALE: 8" : 1'-0"

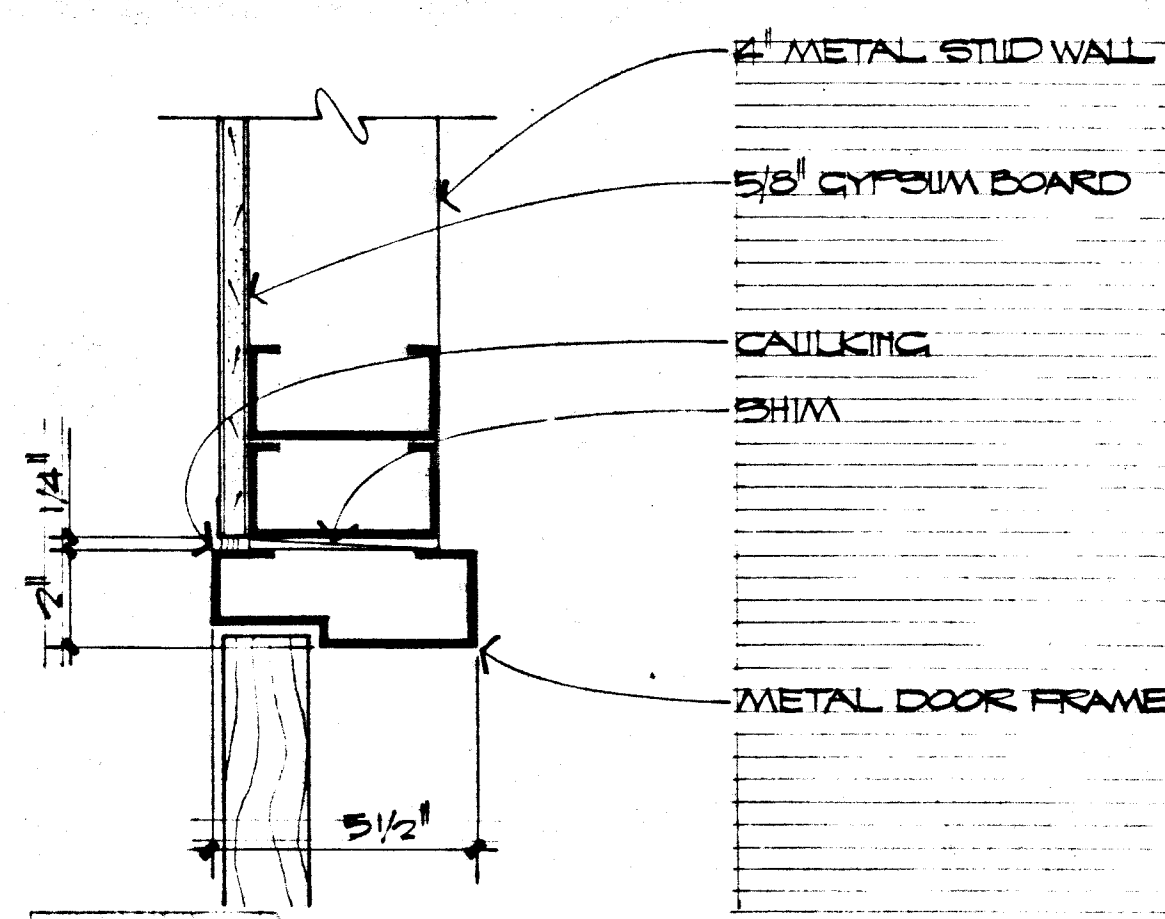

JAMB
SCALE: 8" : 1'-0"

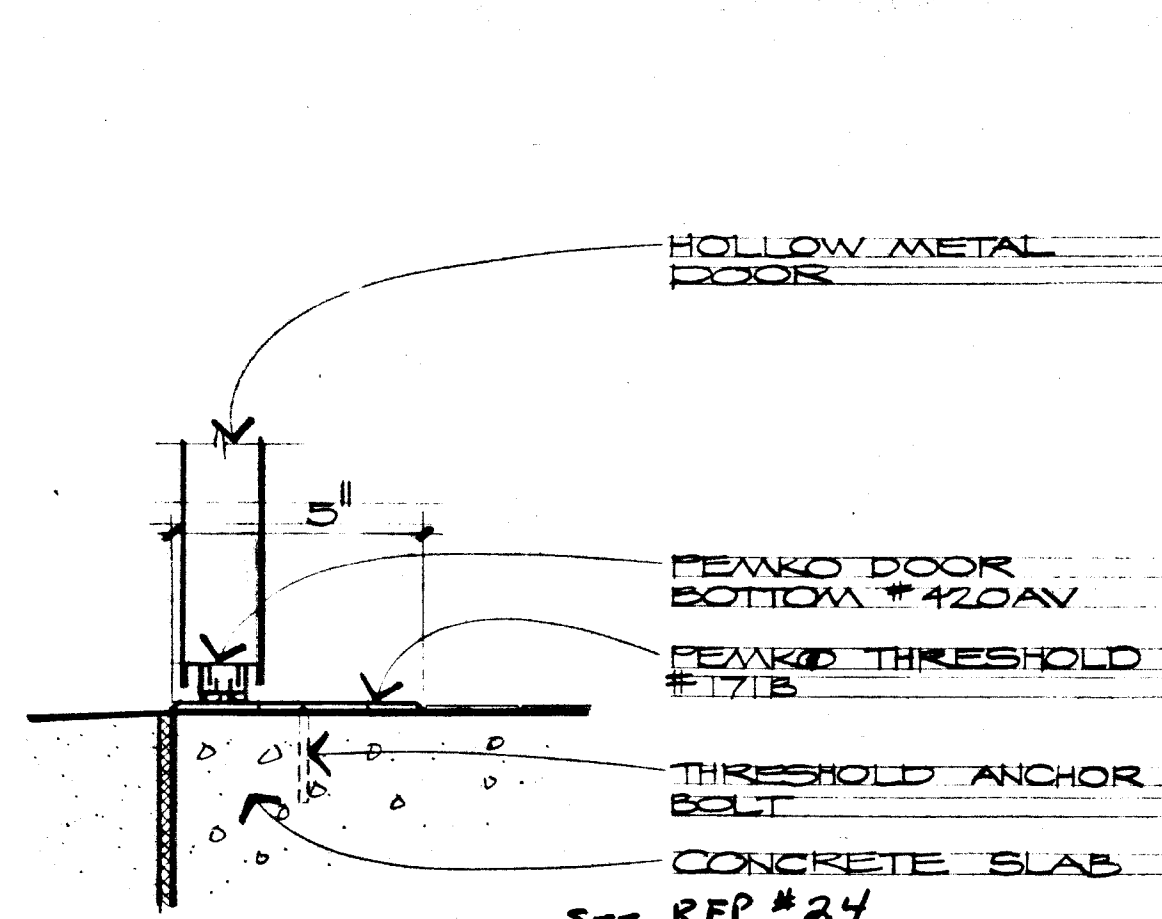

THRESHOLD see RFP #24
SCALE: 8" : 1'-0"

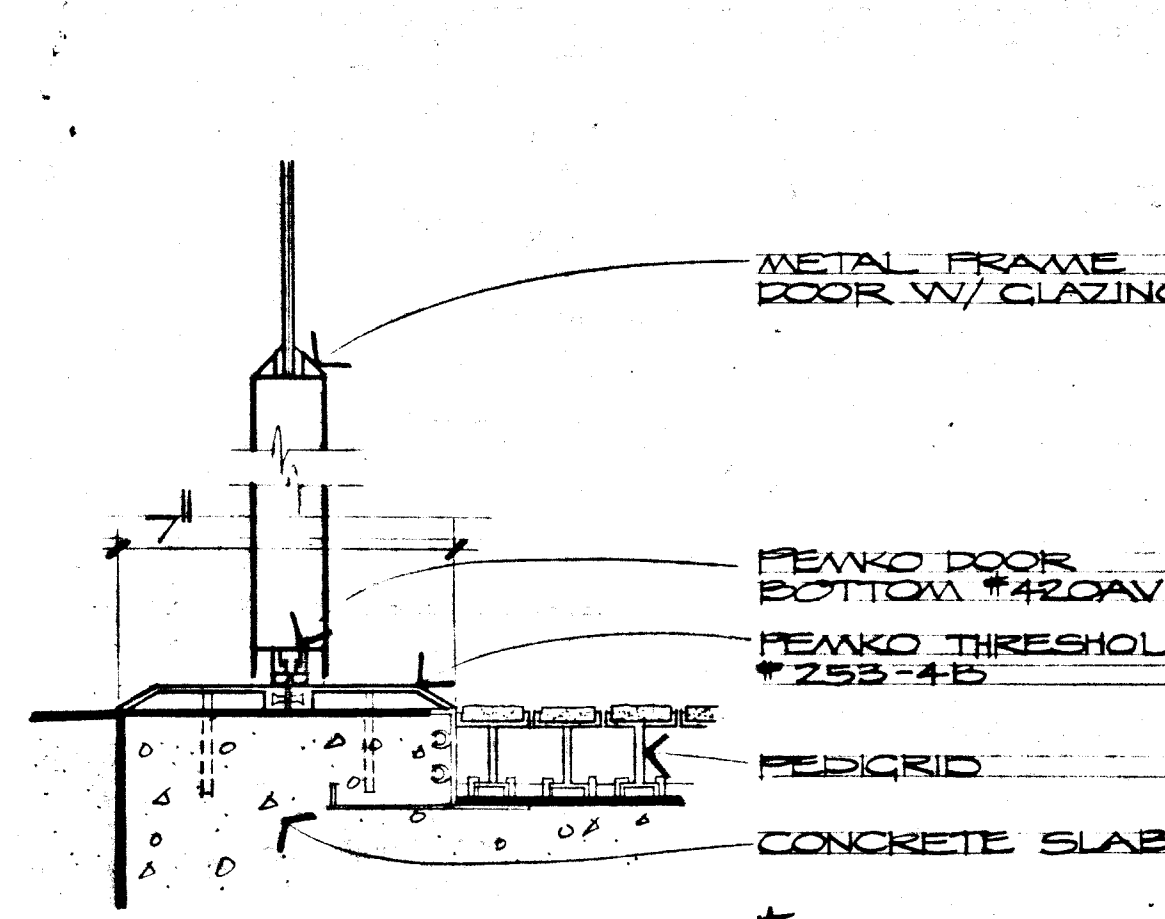

THRESHOLD see RFP #24
SCALE: 8" : 1'-0"

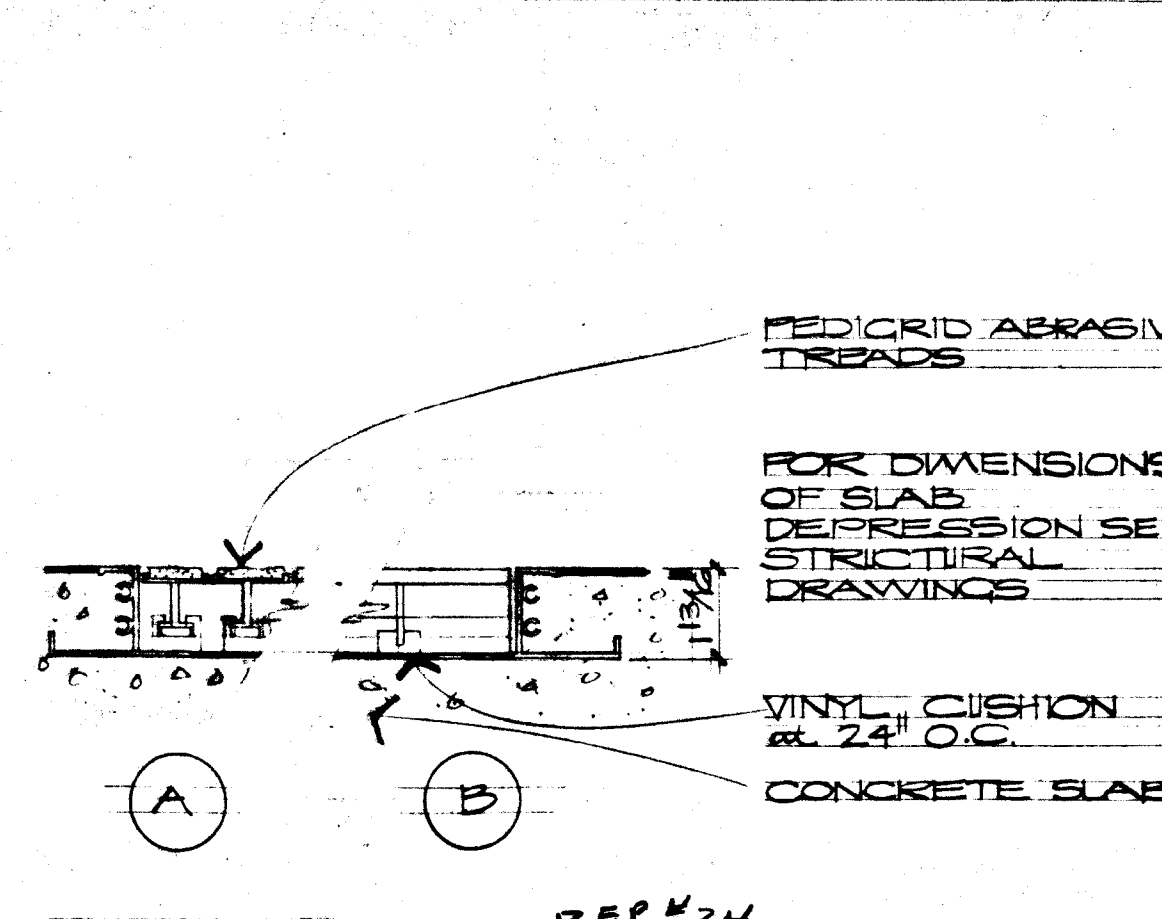

DETAIL see RFP #24
SCALE: 8" : 1'-0"

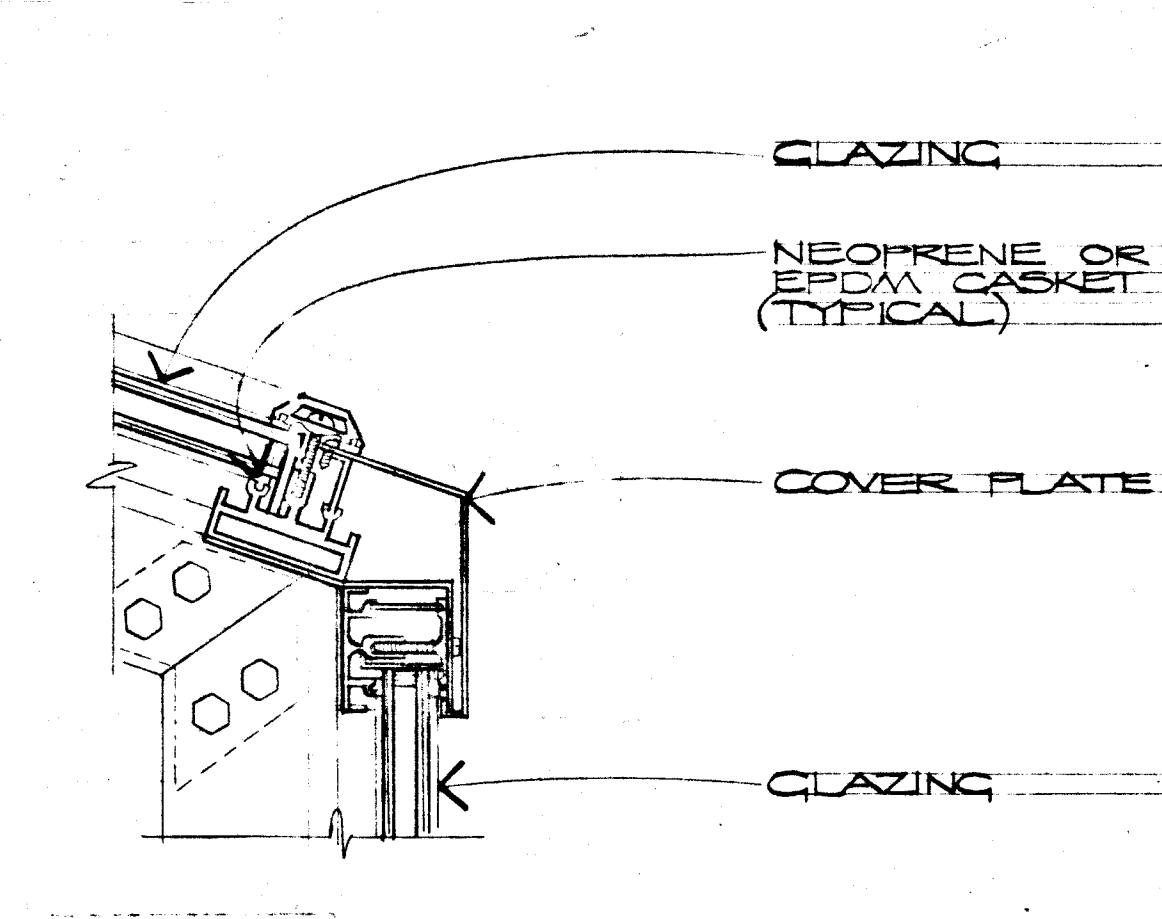

DETAIL
SCALE: 8" : 1'-0"

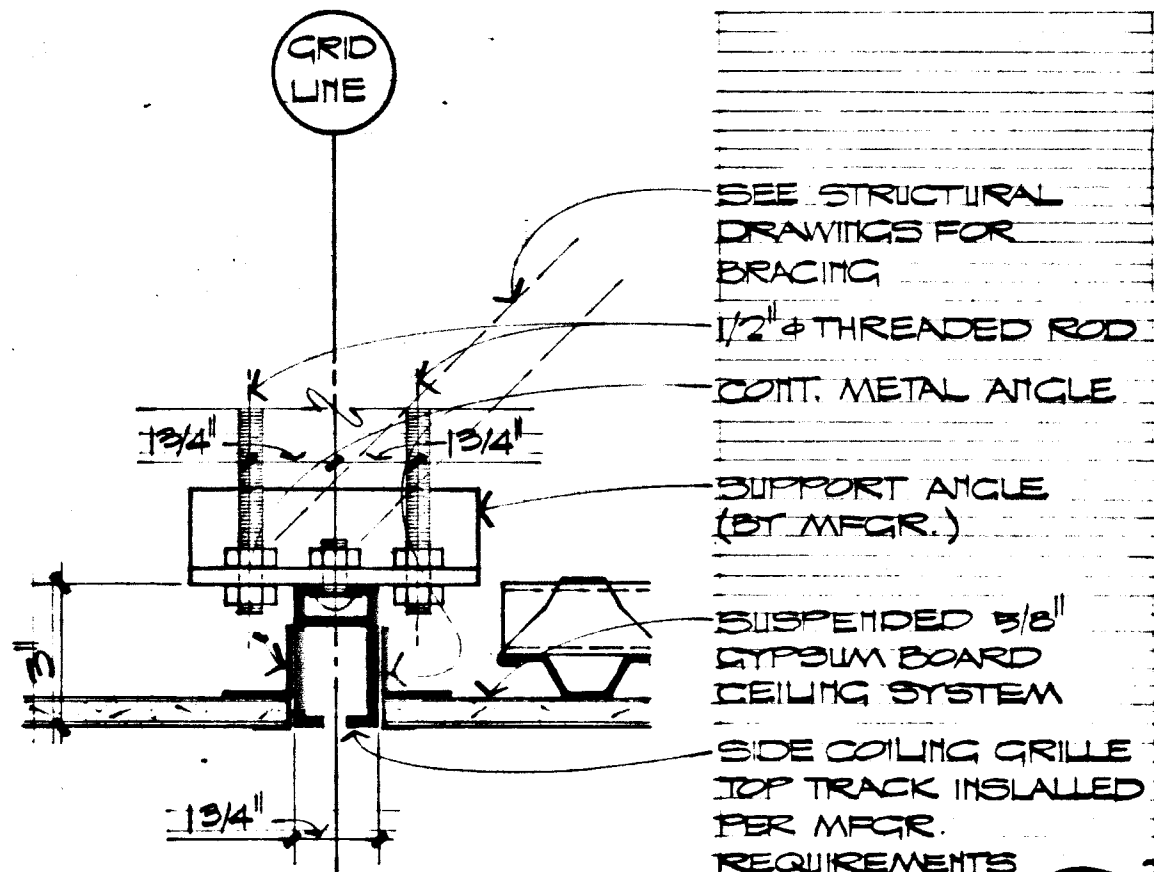

HEAD
SCALE: 8" : 1'-0"

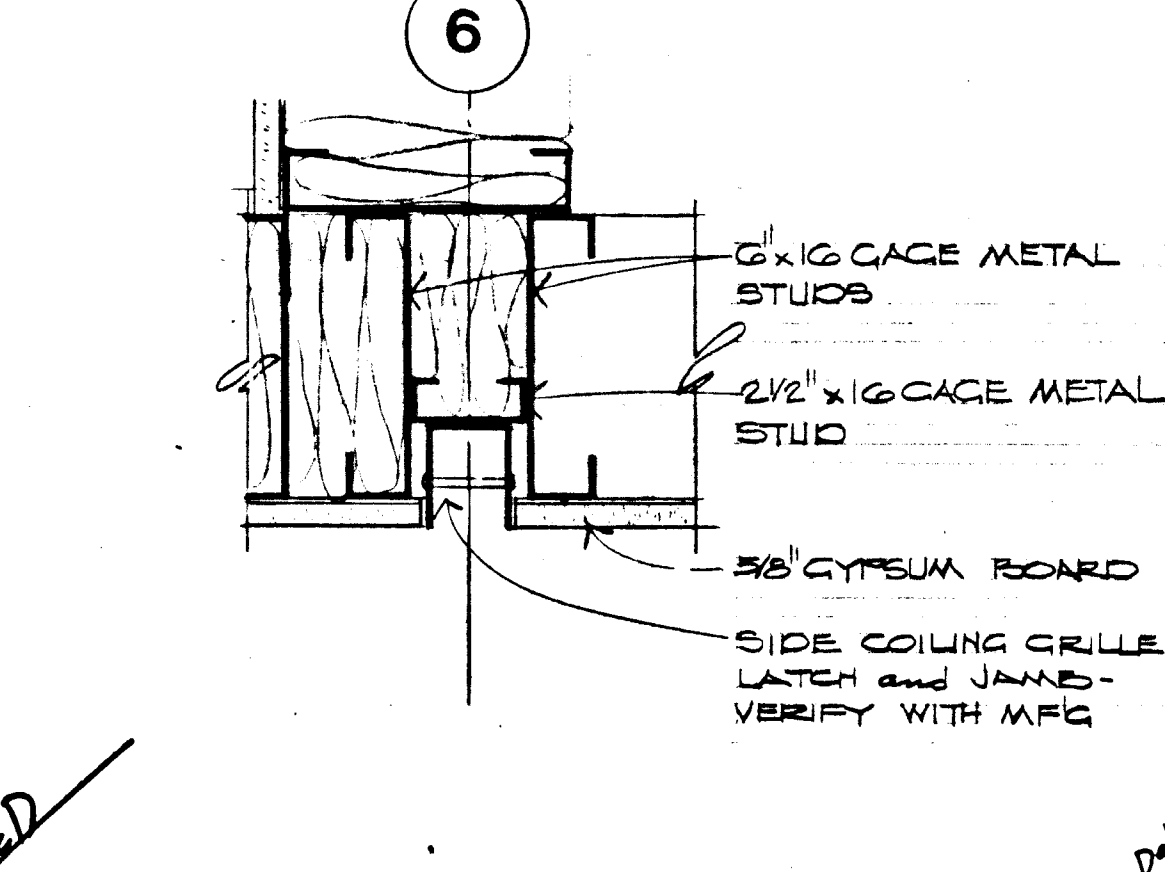

JAMB
SCALE: 8" : 1'-0"

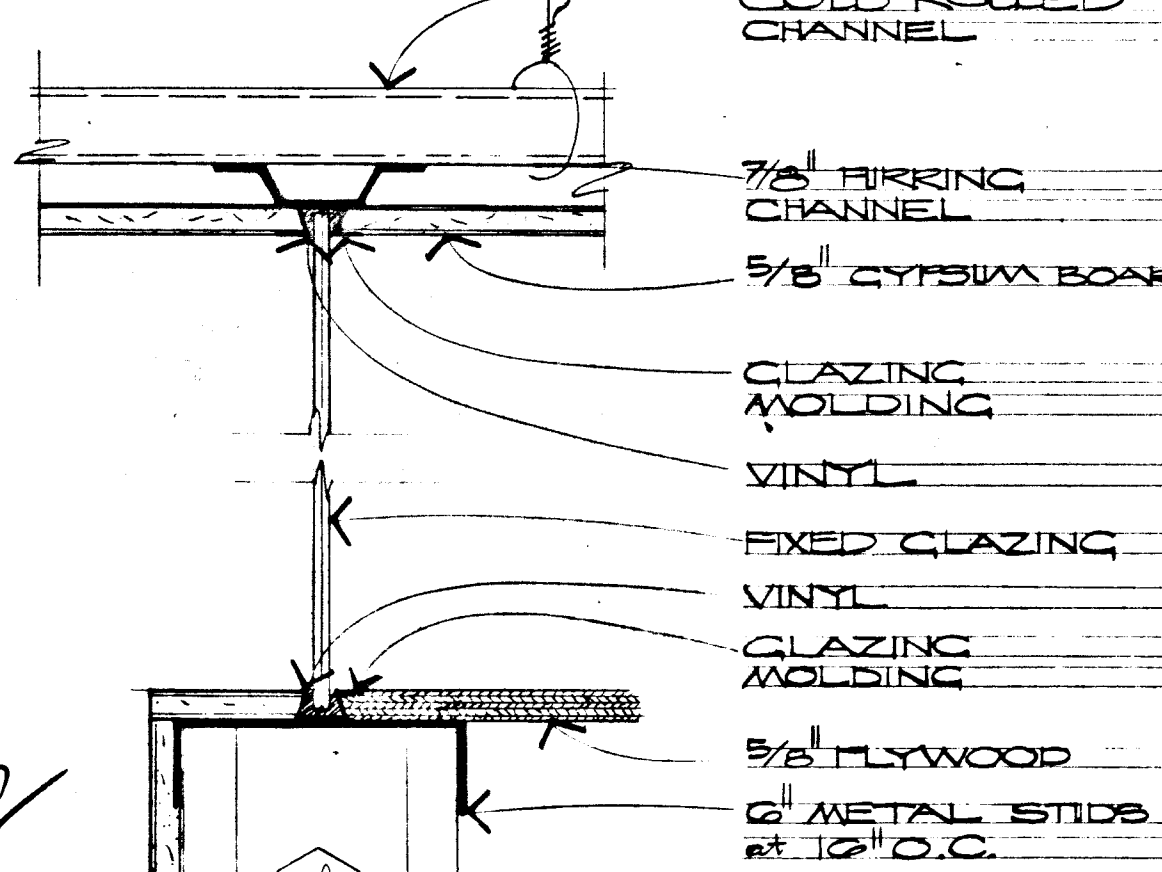

DETAIL
SCALE: 8" : 1'-0"

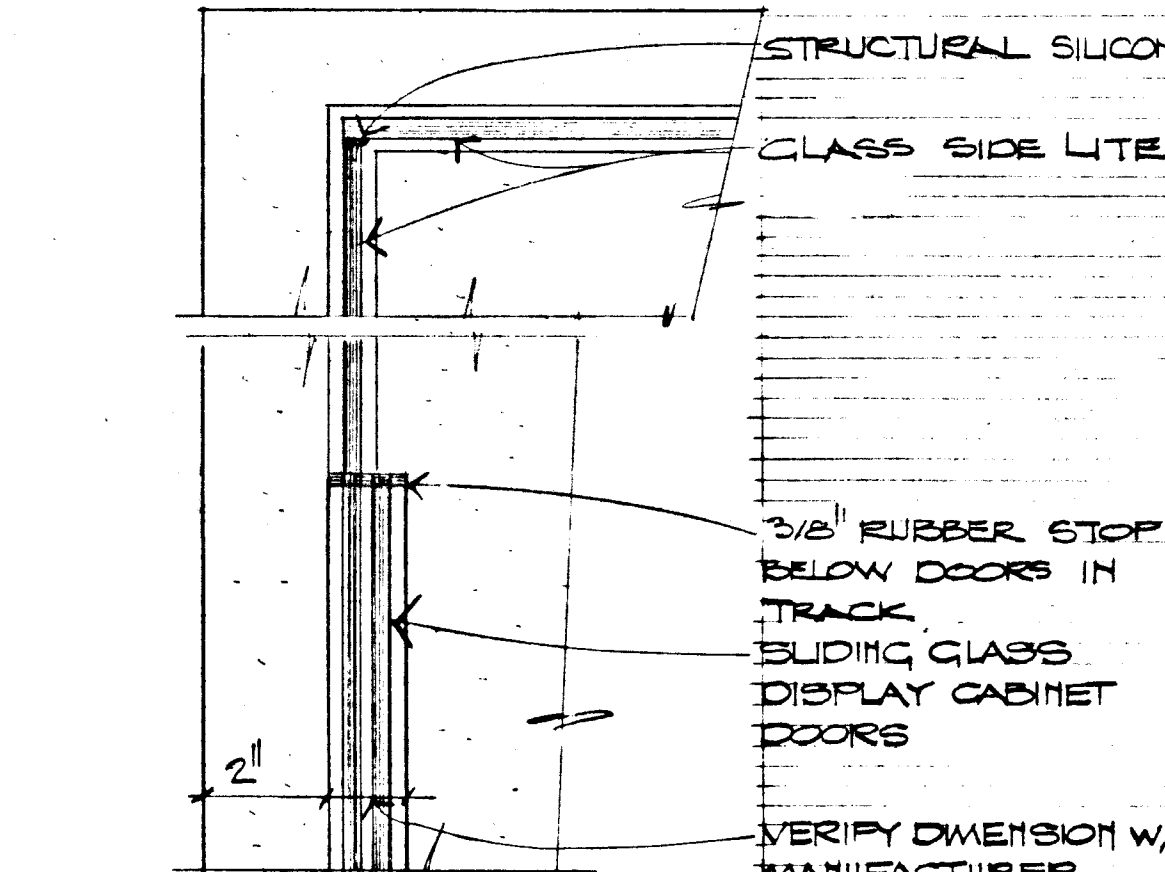

JAMB
SCALE: 8" : 1'-0"

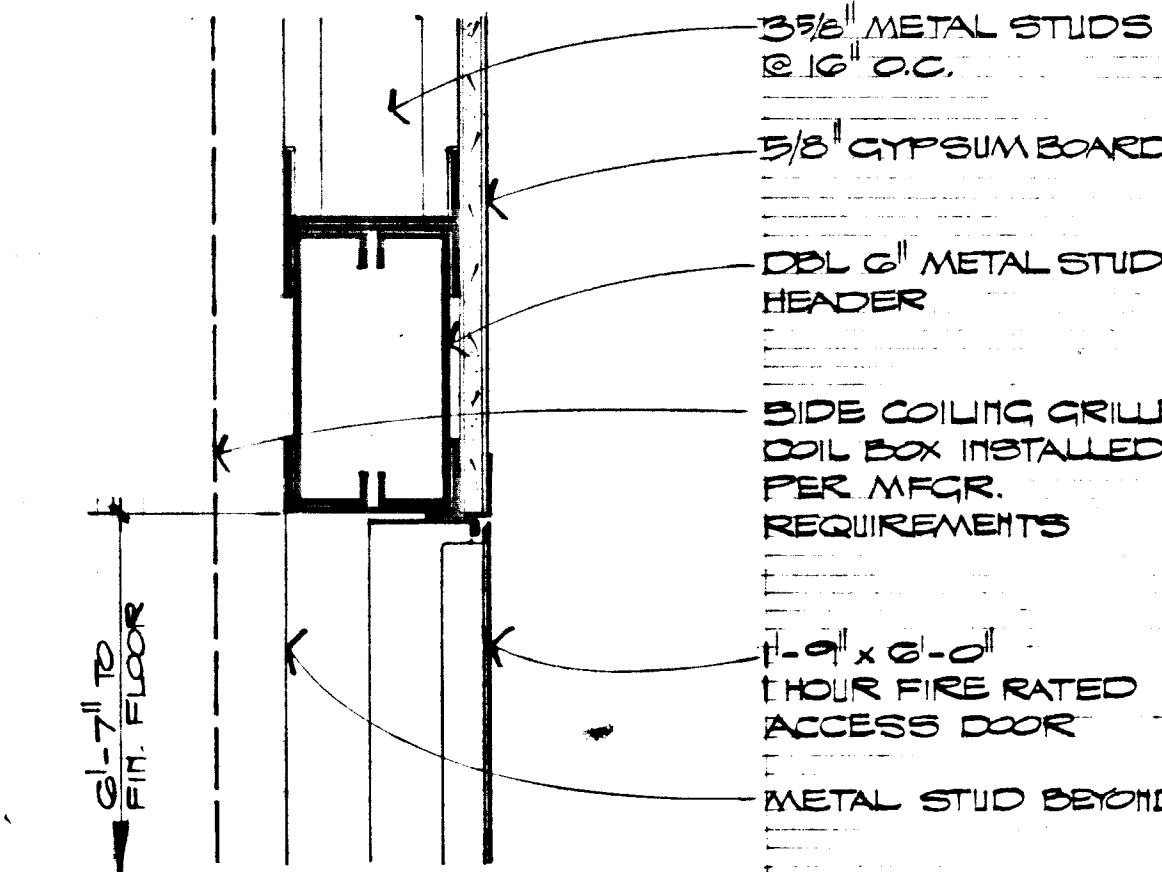

HEAD
SCALE: 8" : 1'-0"

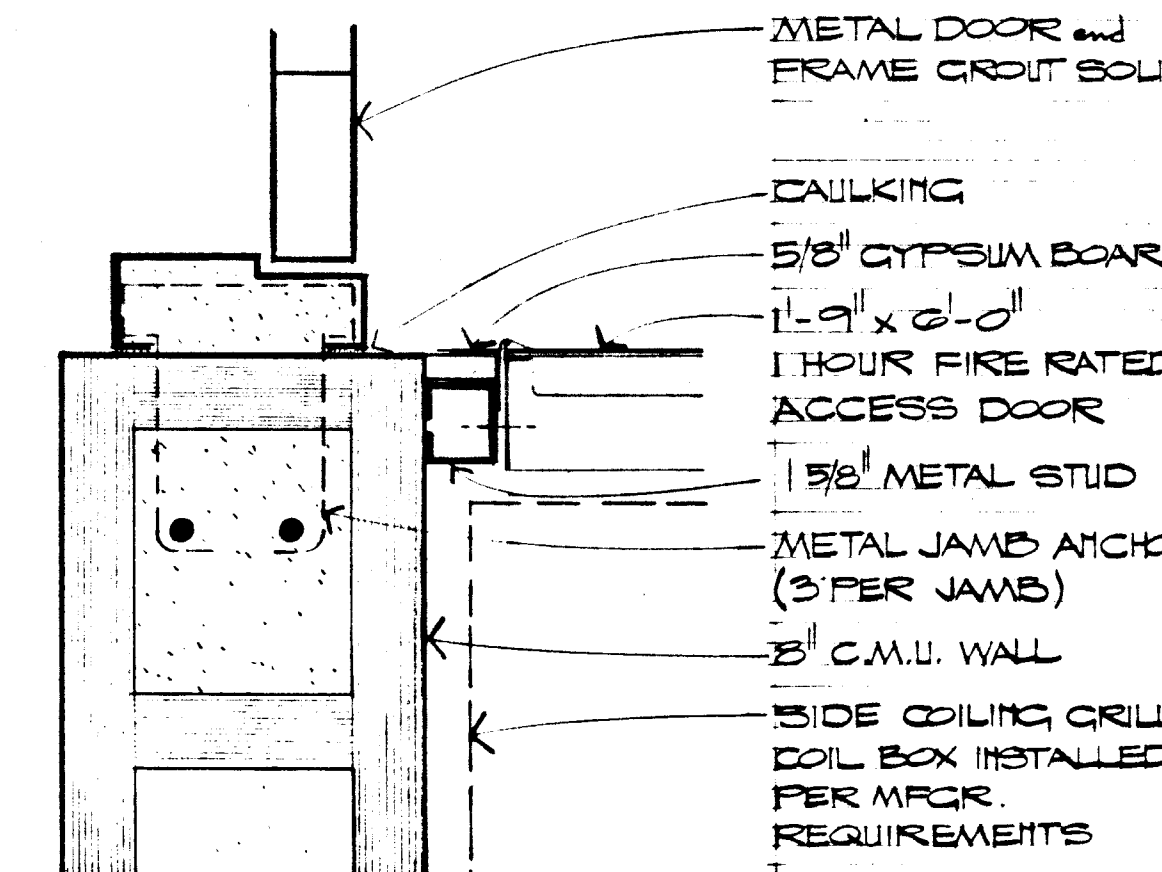

JAMB
SCALE: 8" : 1'-0"

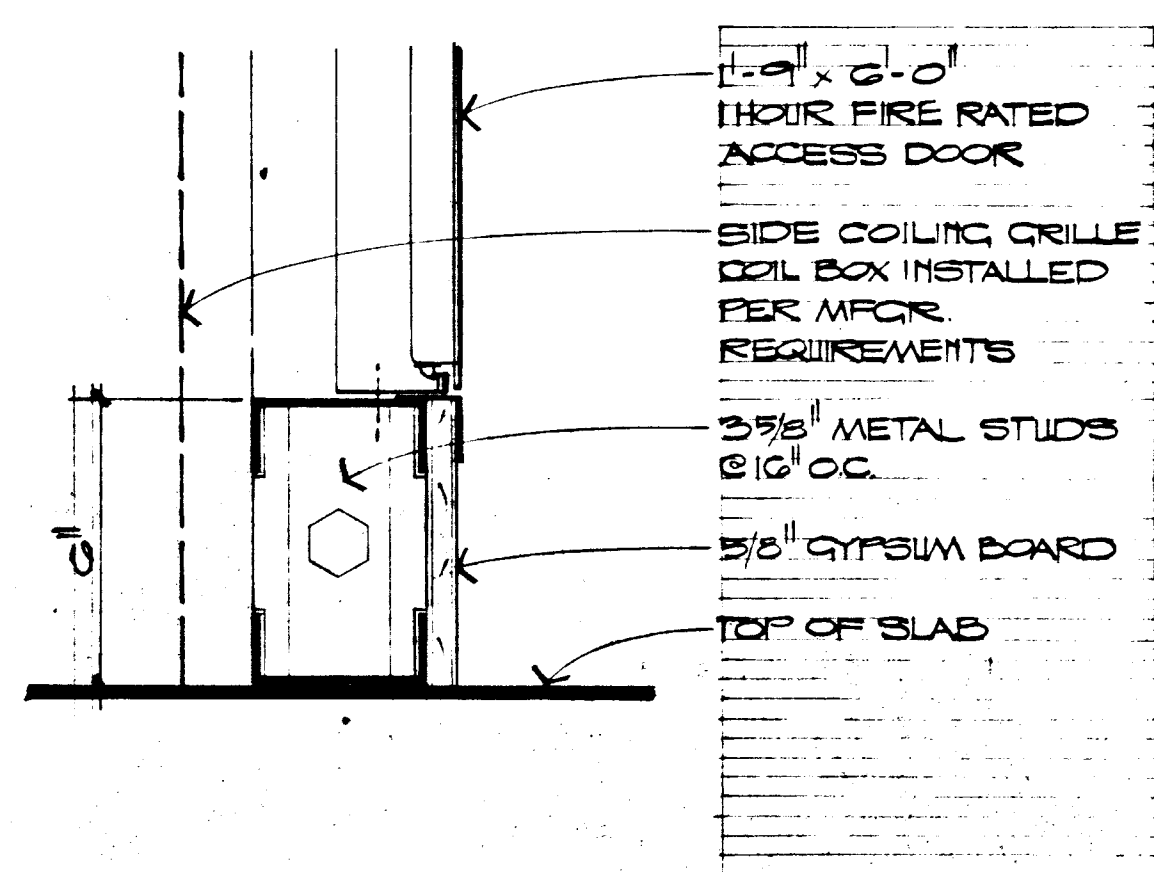

SILL
SCALE: 8" : 1'-0"

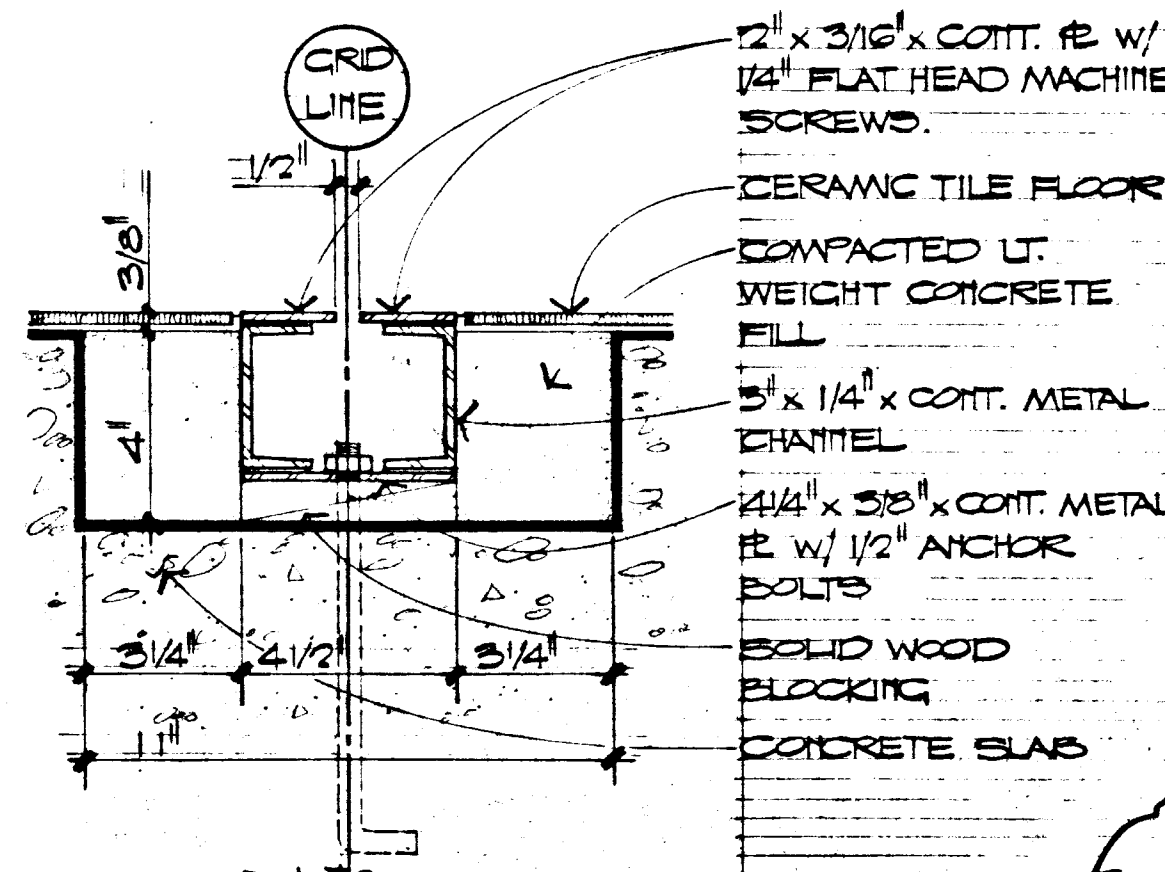

SILL see RFP #8
SCALE: 8" : 1'-0"

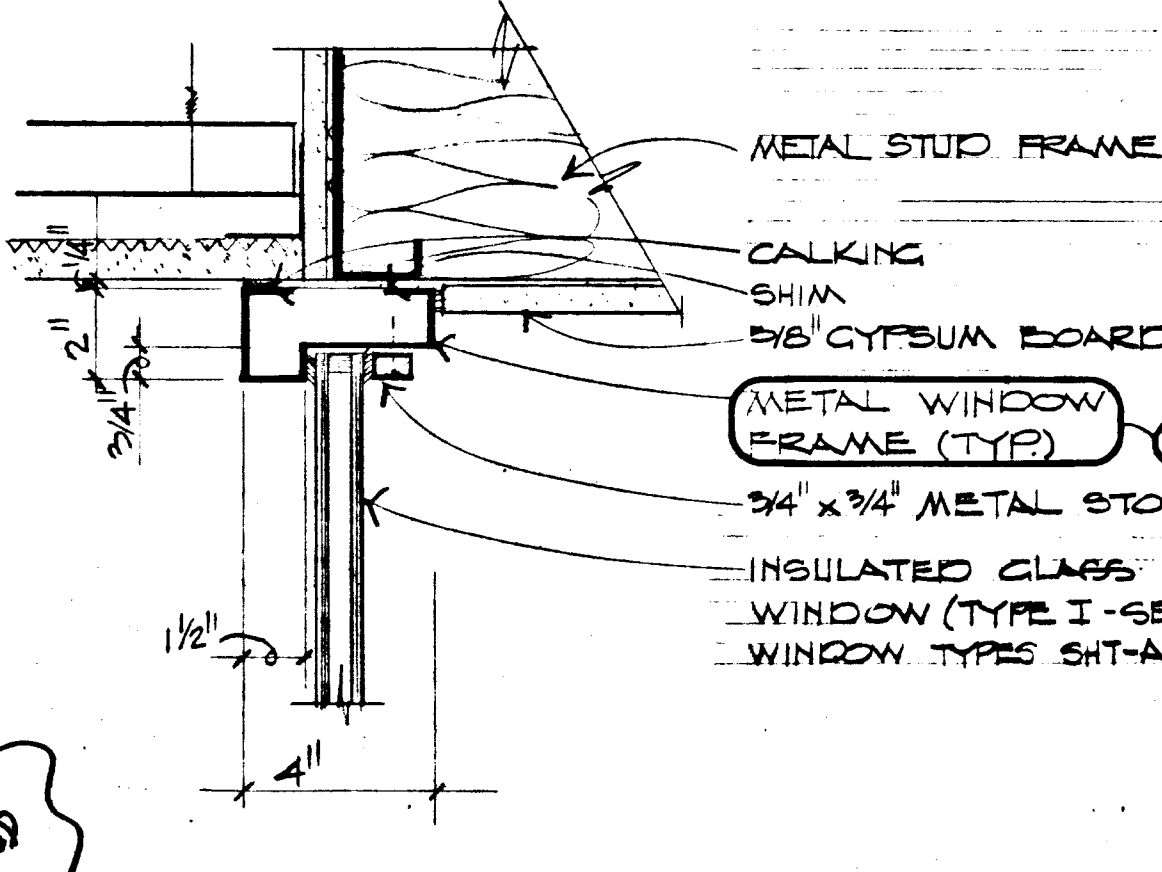

HEAD
SCALE: 8" : 1'-0"

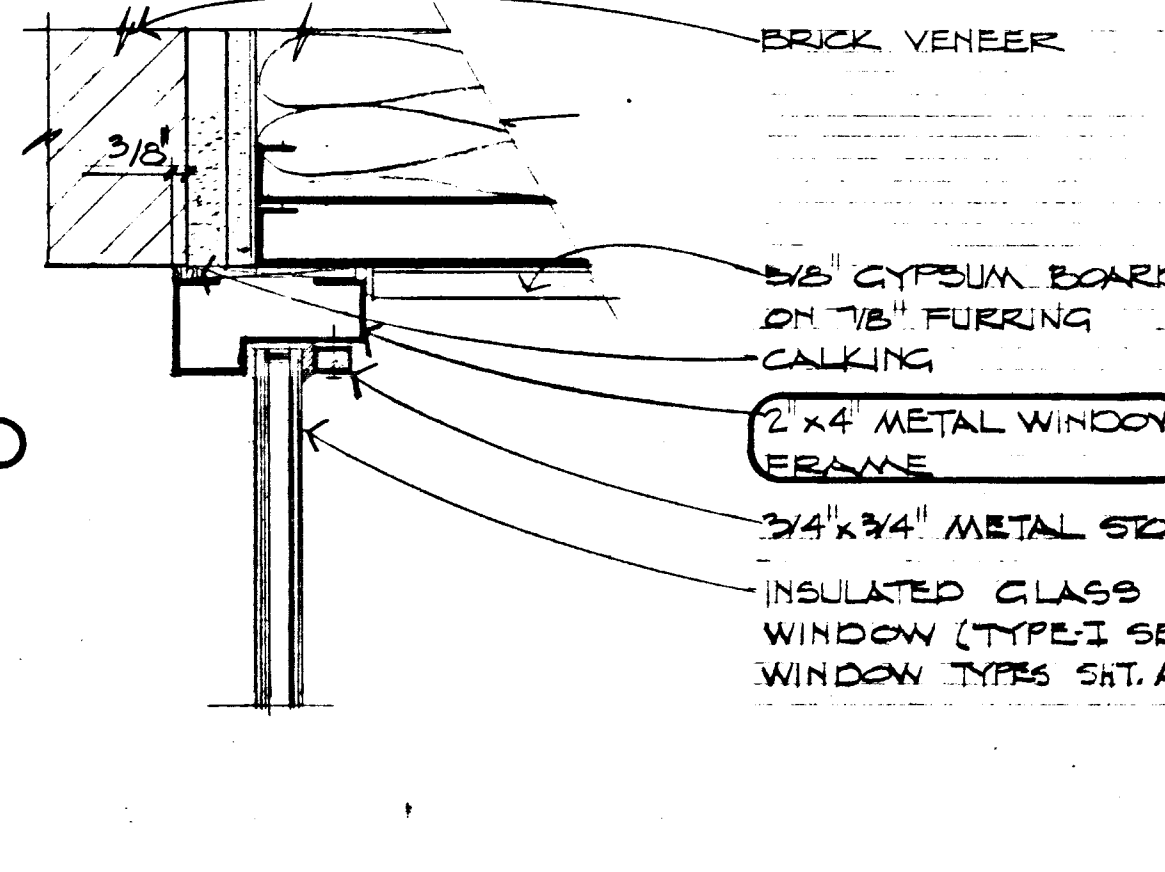

JAMB
SCALE: 8" : 1'-0"

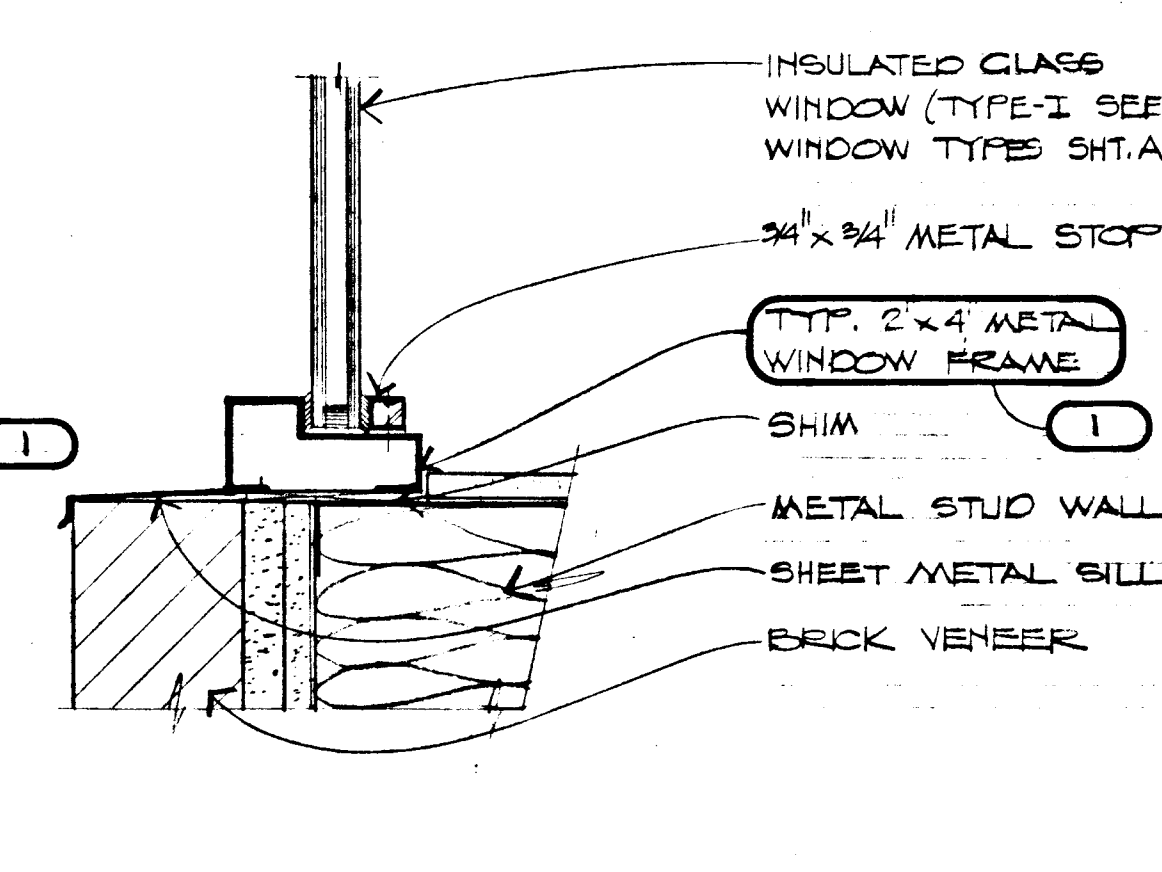

SILL
SCALE: 8" : 1'-0"

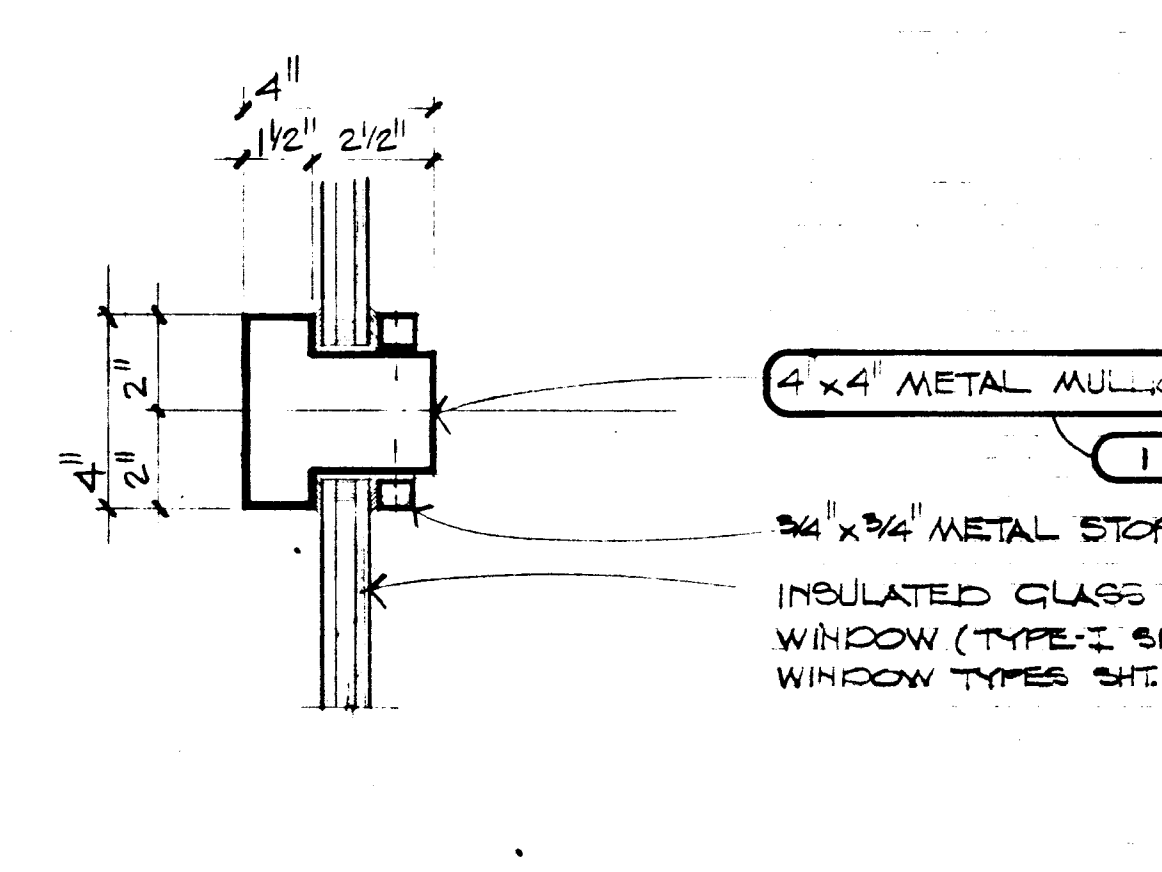

MULLION
SCALE: 8" : 1'-0"

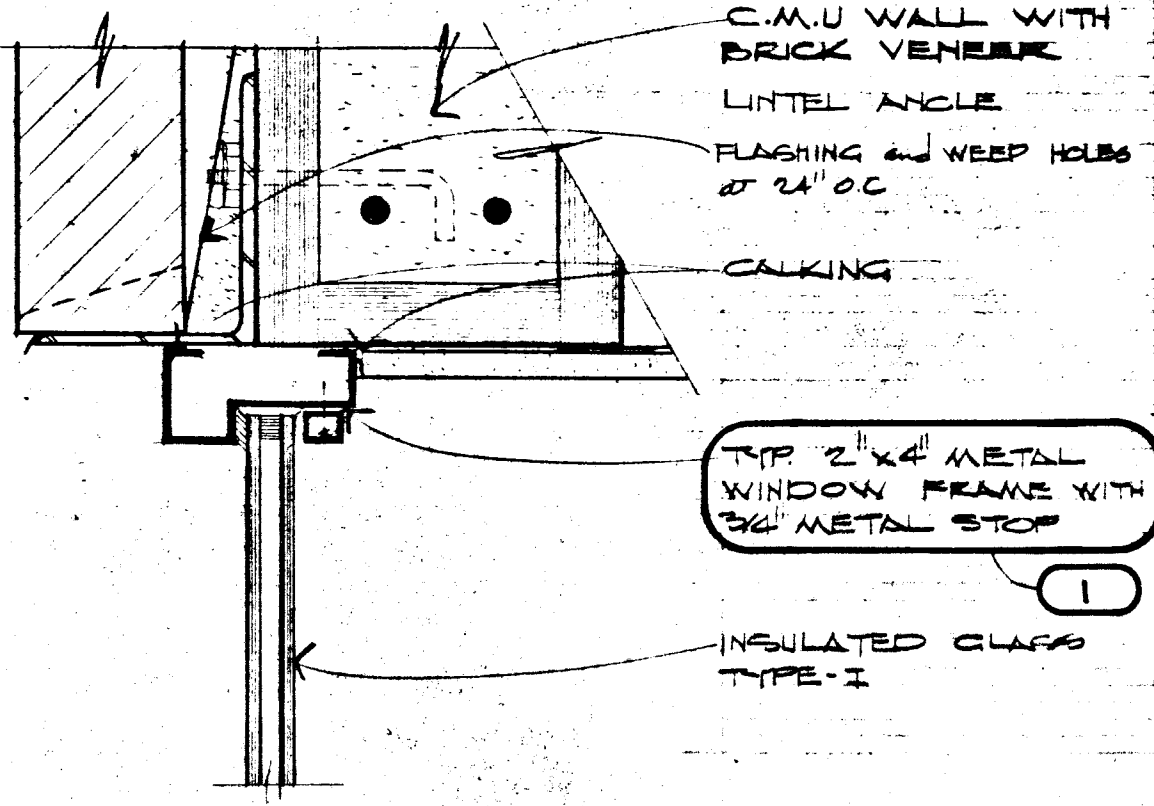

HEAD
SCALE: 8" : 1'-0"

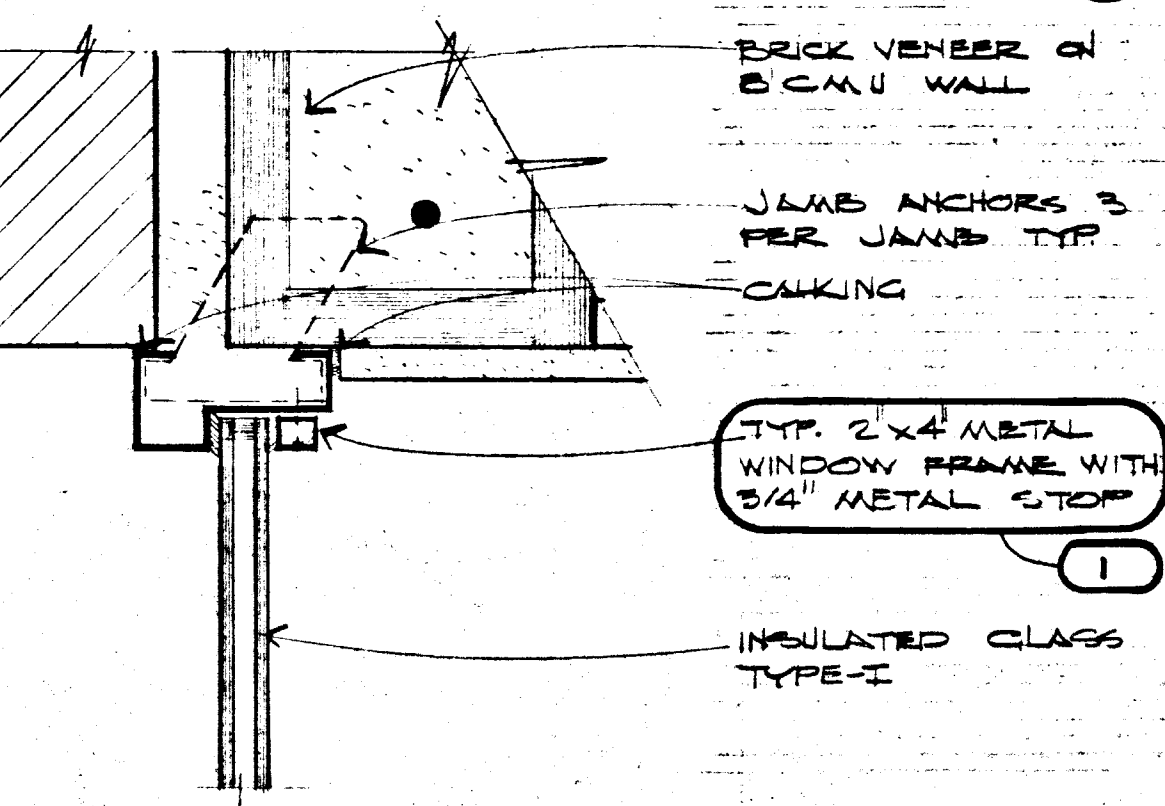

JAMB
SCALE: 8" : 1'-0"

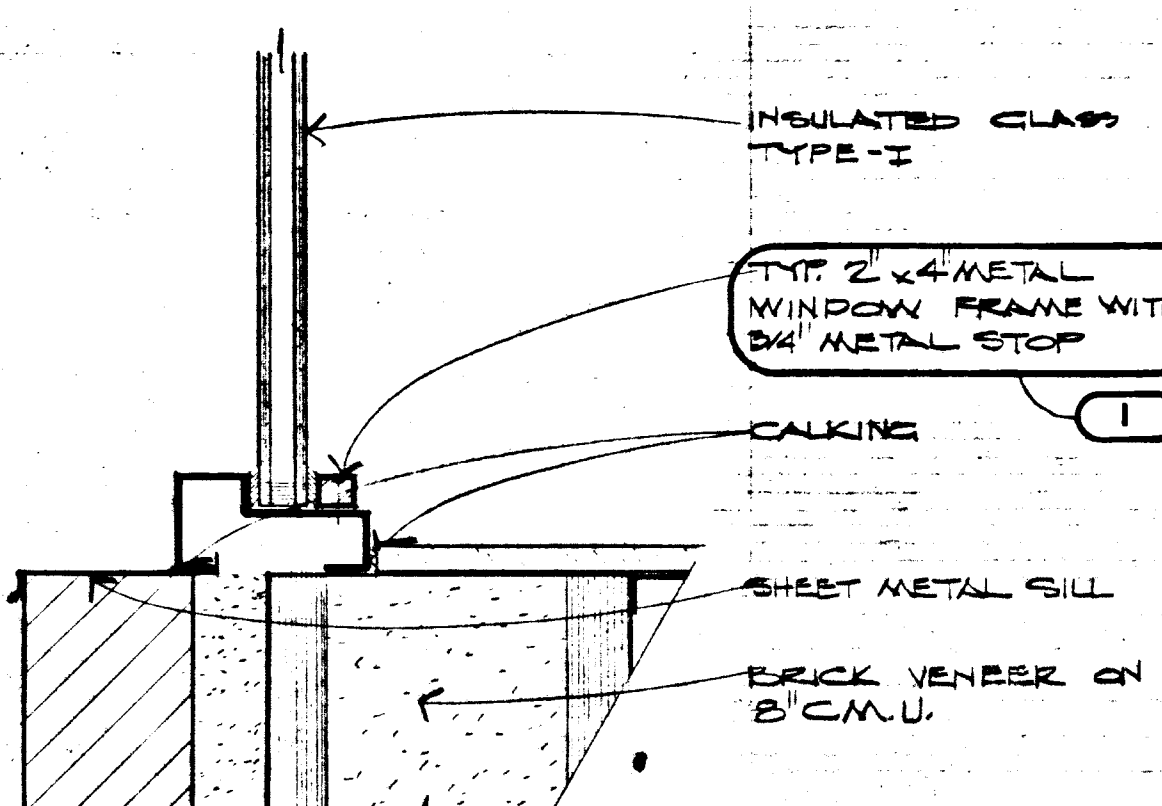

SILL
SCALE: 8" : 1'-0"

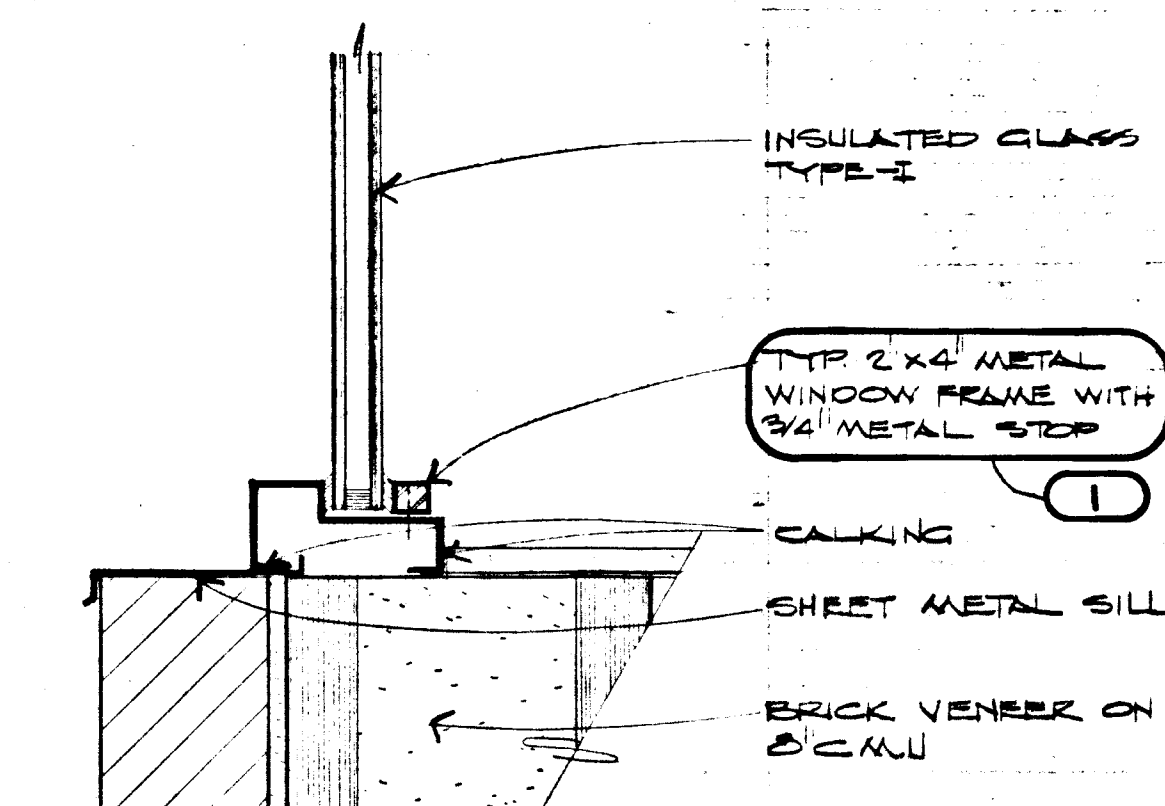

SILL
SCALE: 8" : 1'-0"

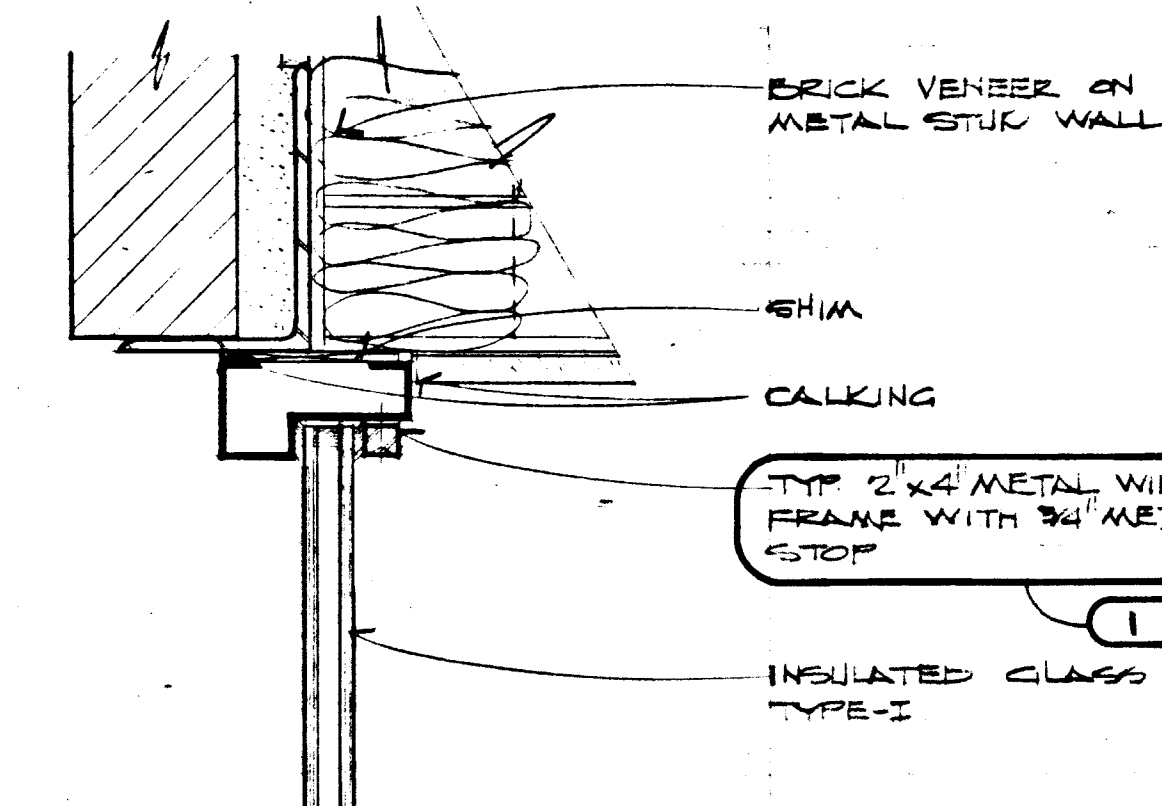

HEAD
SCALE: 8" : 1'-0"

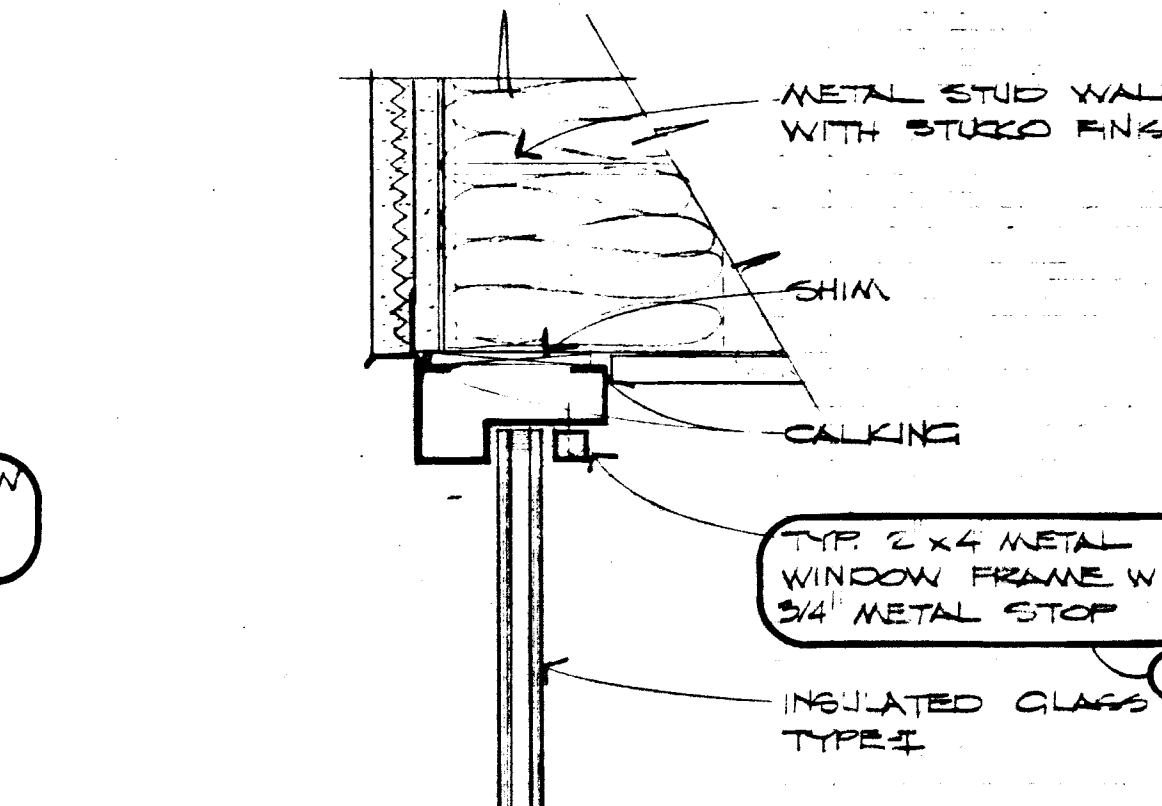

HEAD (JAMB SIMILAR)
SCALE: 8" : 1'-0"

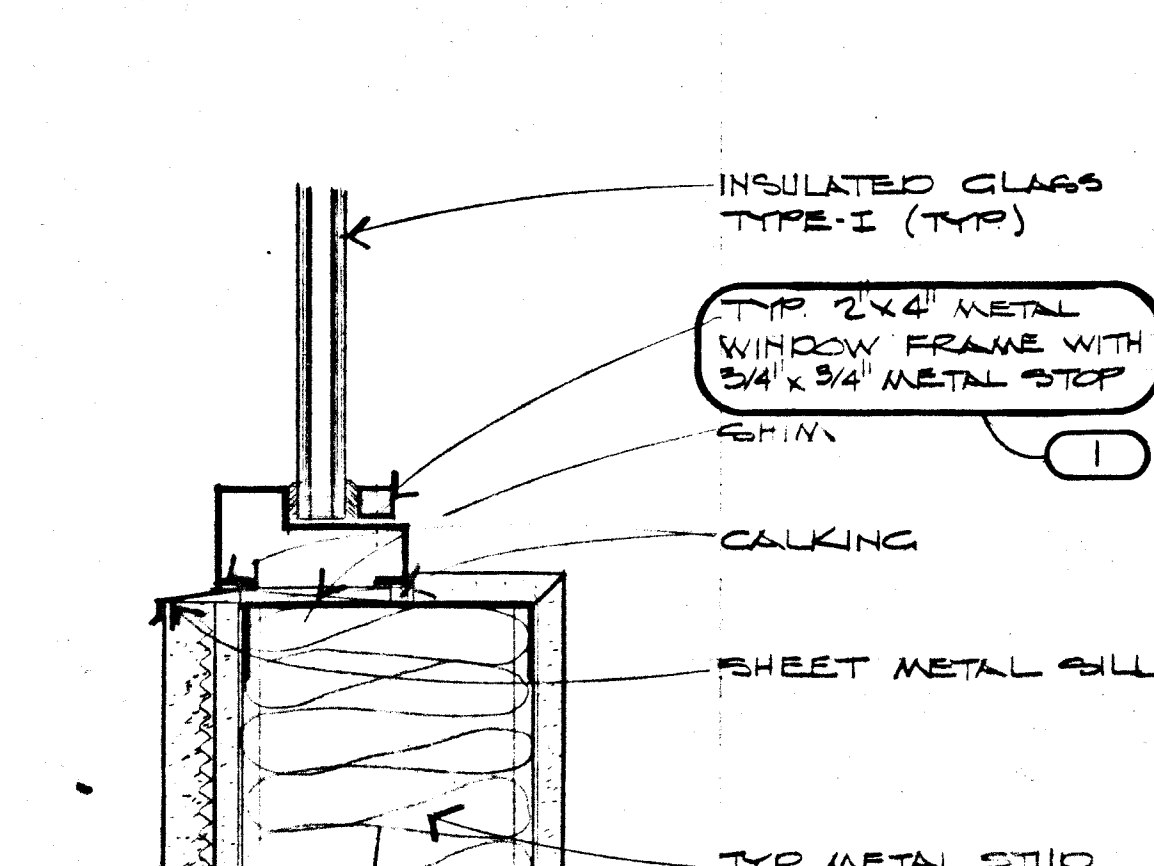

SILL
SCALE: 8" : 1'-0"

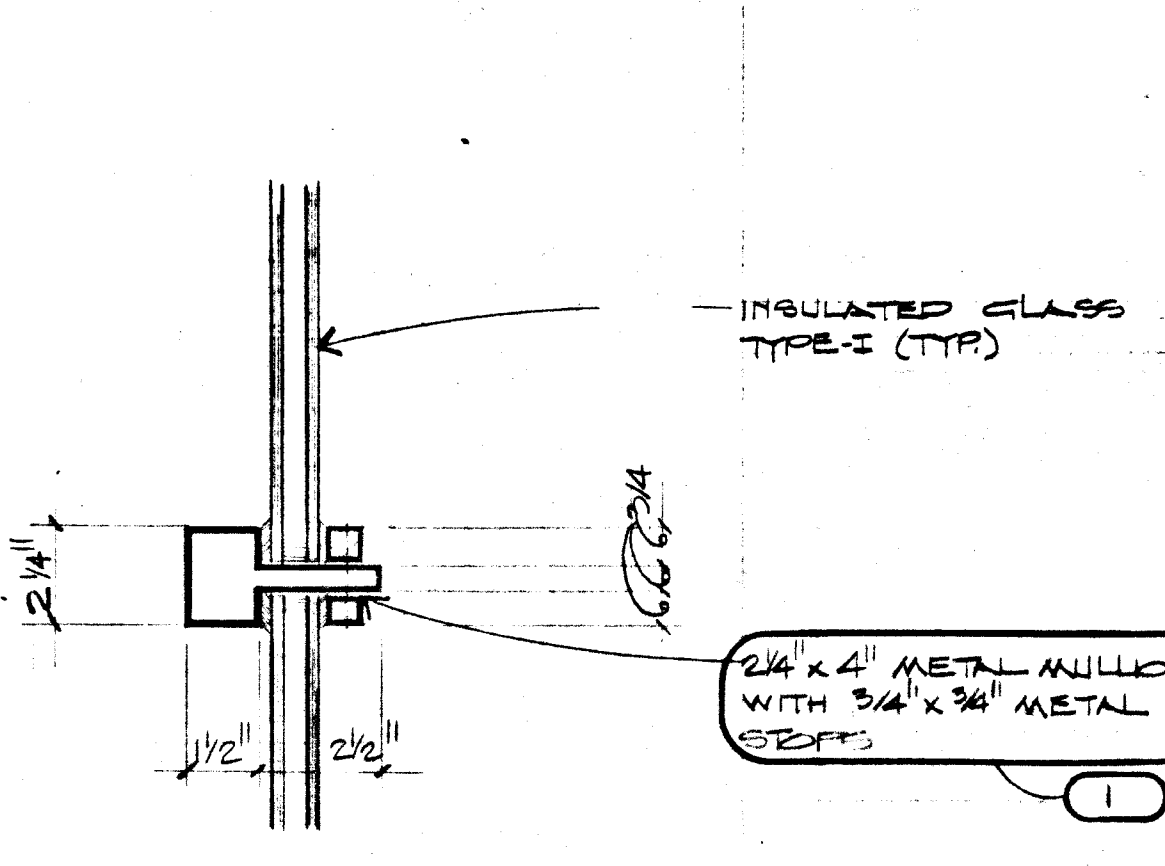

MULLION
SCALE: 8" : 1'-0"

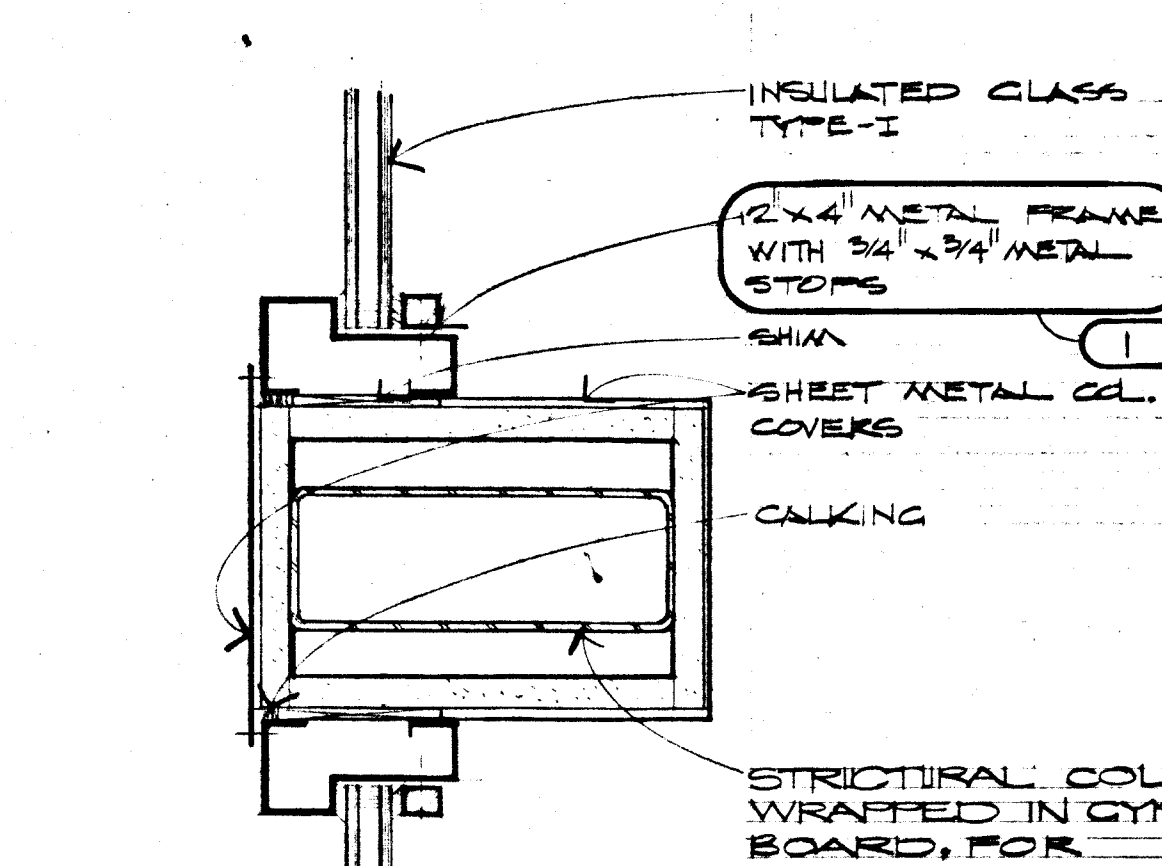

JAMB
SCALE: 8" : 1'-0"

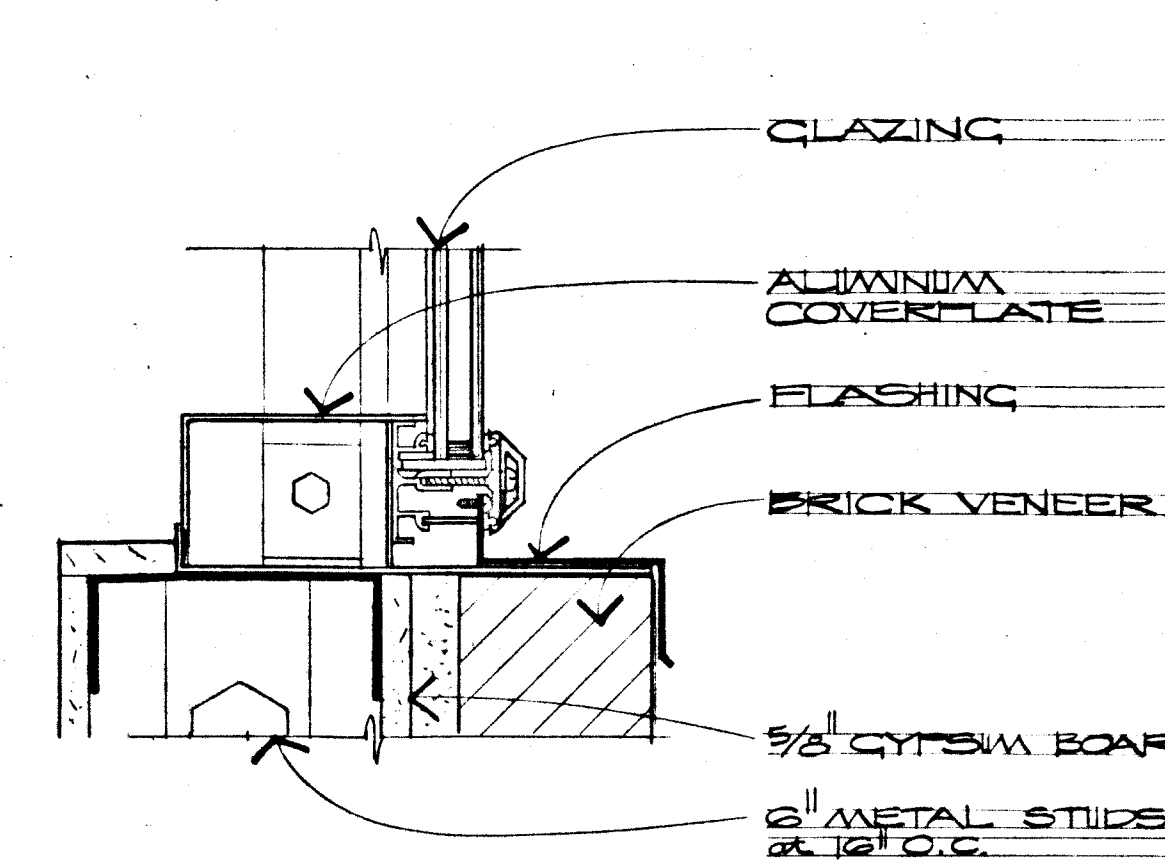

SILL
SCALE: 8" : 1'-0"

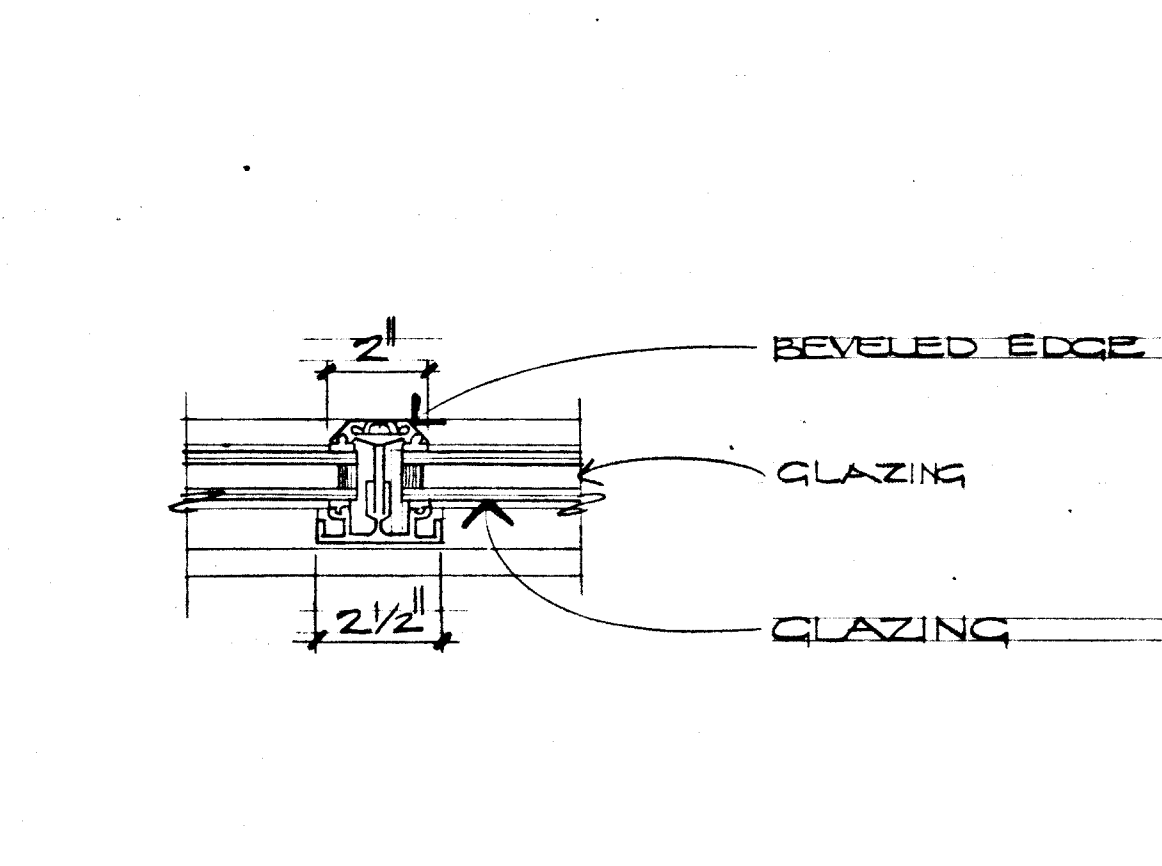

MULLION
SCALE: 8" : 1'-0"

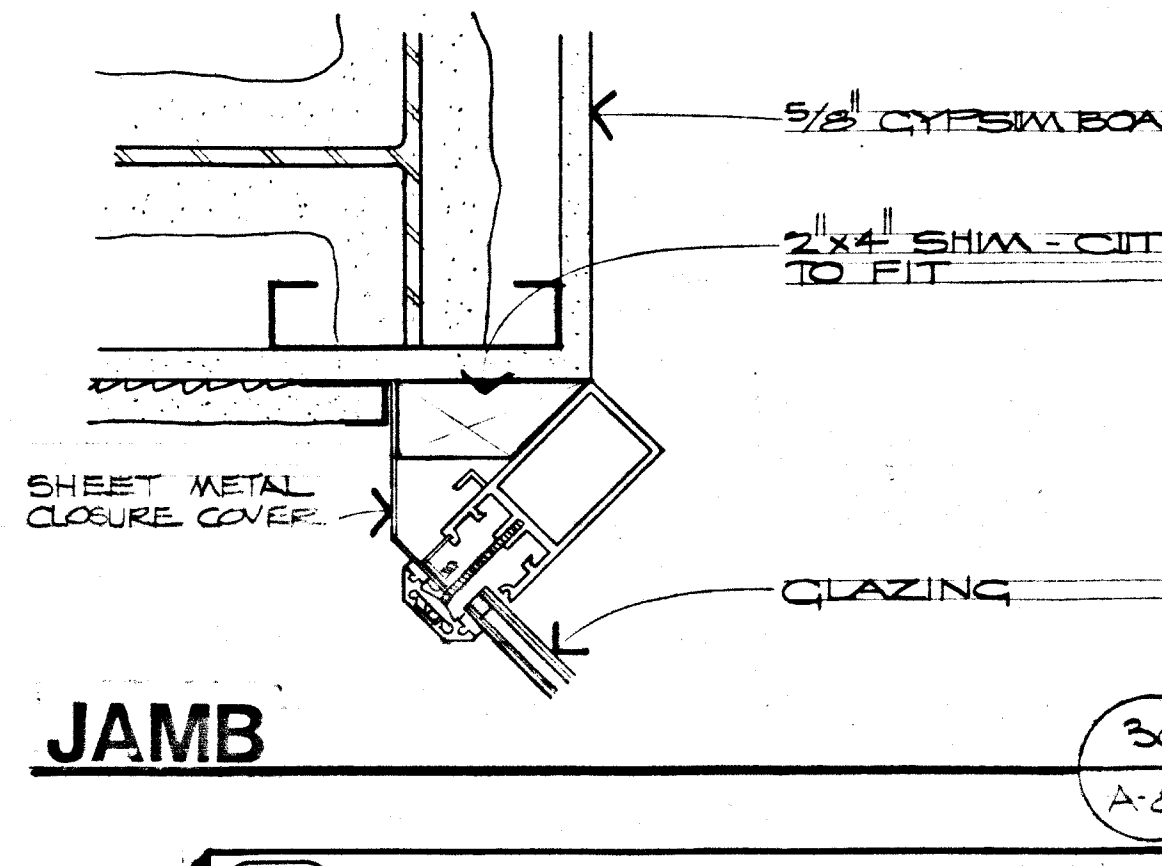

JAMB
SCALE: 8" : 1'-0"

1 DEDUCTIVE BID ITEM #1 (T)
IN LIEU OF METAL WINDOW FRAMES AS SHOWN SUBSTITUTE ALUM. WINDOW FRAMES FOR DETAIL DESCRIPTION SEE SPECIFICATIONS

DOBUSKY KITTRELL GARLOCK aita
 Architects
 3333 CAMBRIDGE ST. LAS VEGAS, NEVADA 89109 (702) 735-1455
 City of Las Vegas
 Transportation
 Downtown
 Las Vegas, Nevada
 A-8
 179165
 600-21