

HEAD
SCALE: 8" = 1'-0"
1 A-7

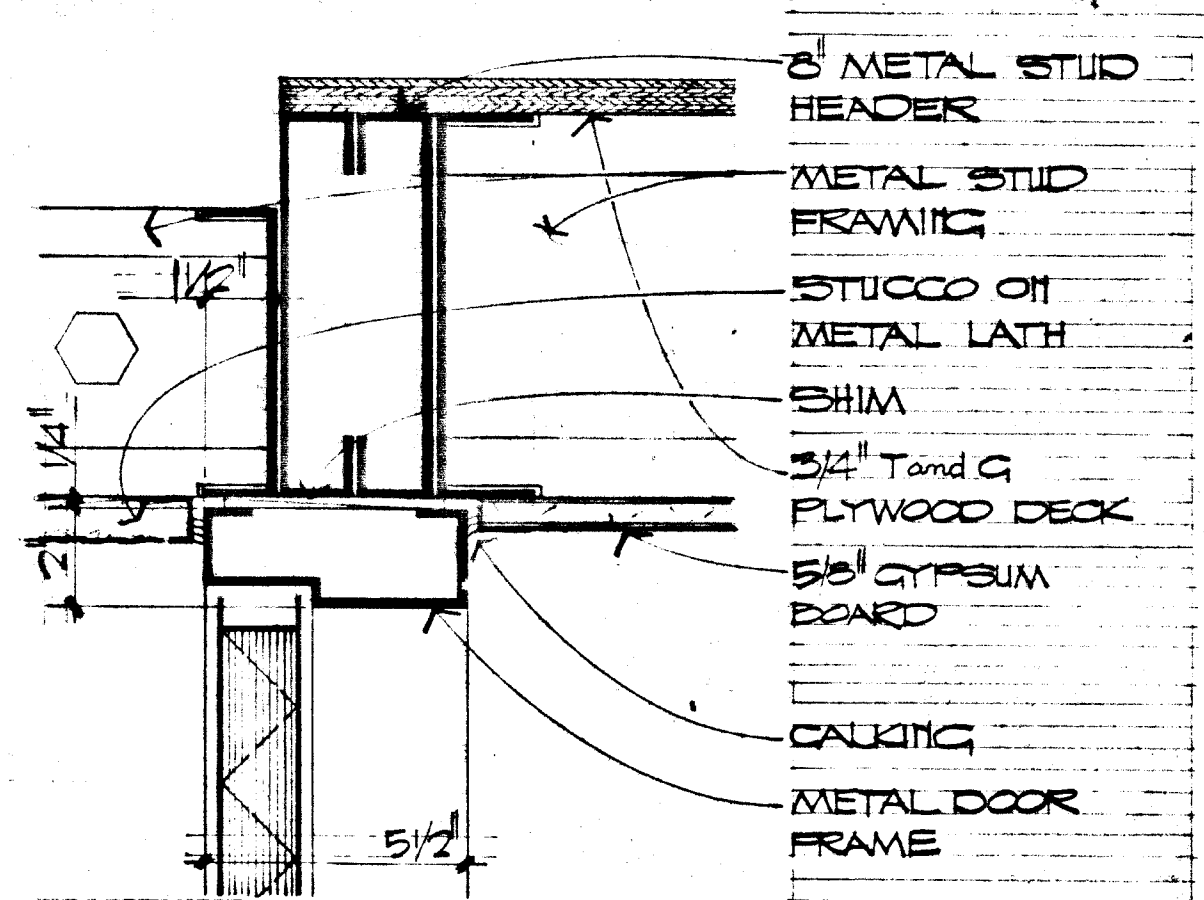

HEAD
SCALE: 8" = 1'-0"
2 A-7

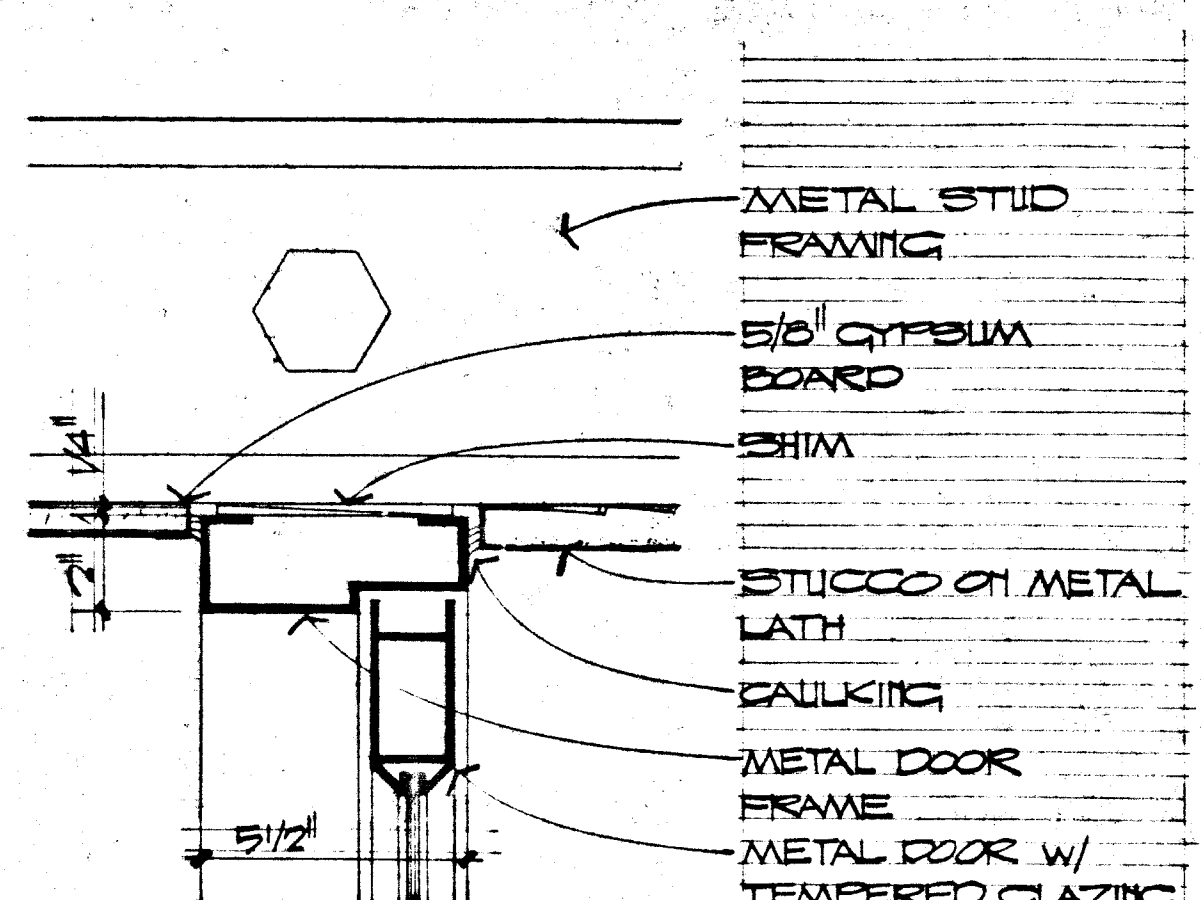

HEAD
SCALE: 8" = 1'-0"
3 A-7

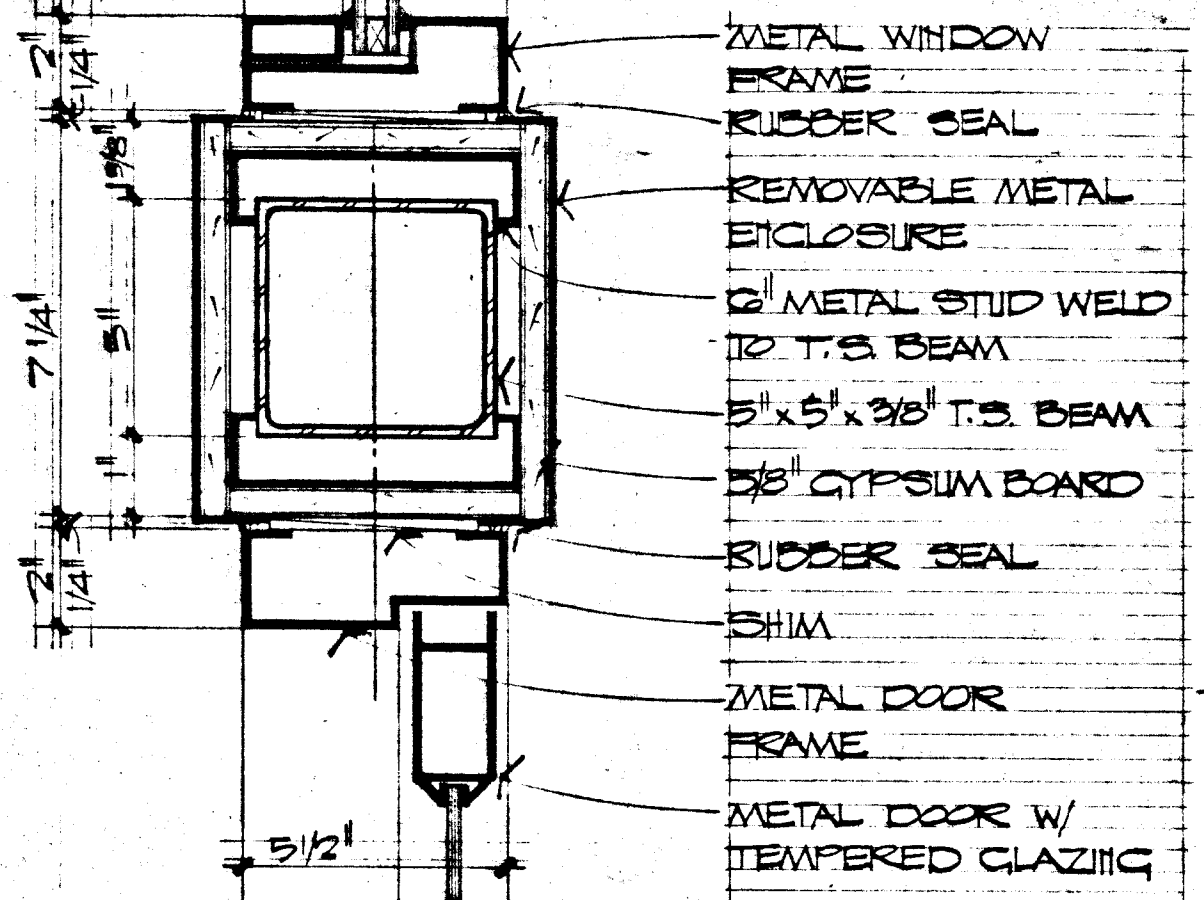

HEAD
SCALE: 8" = 1'-0"
4 A-7

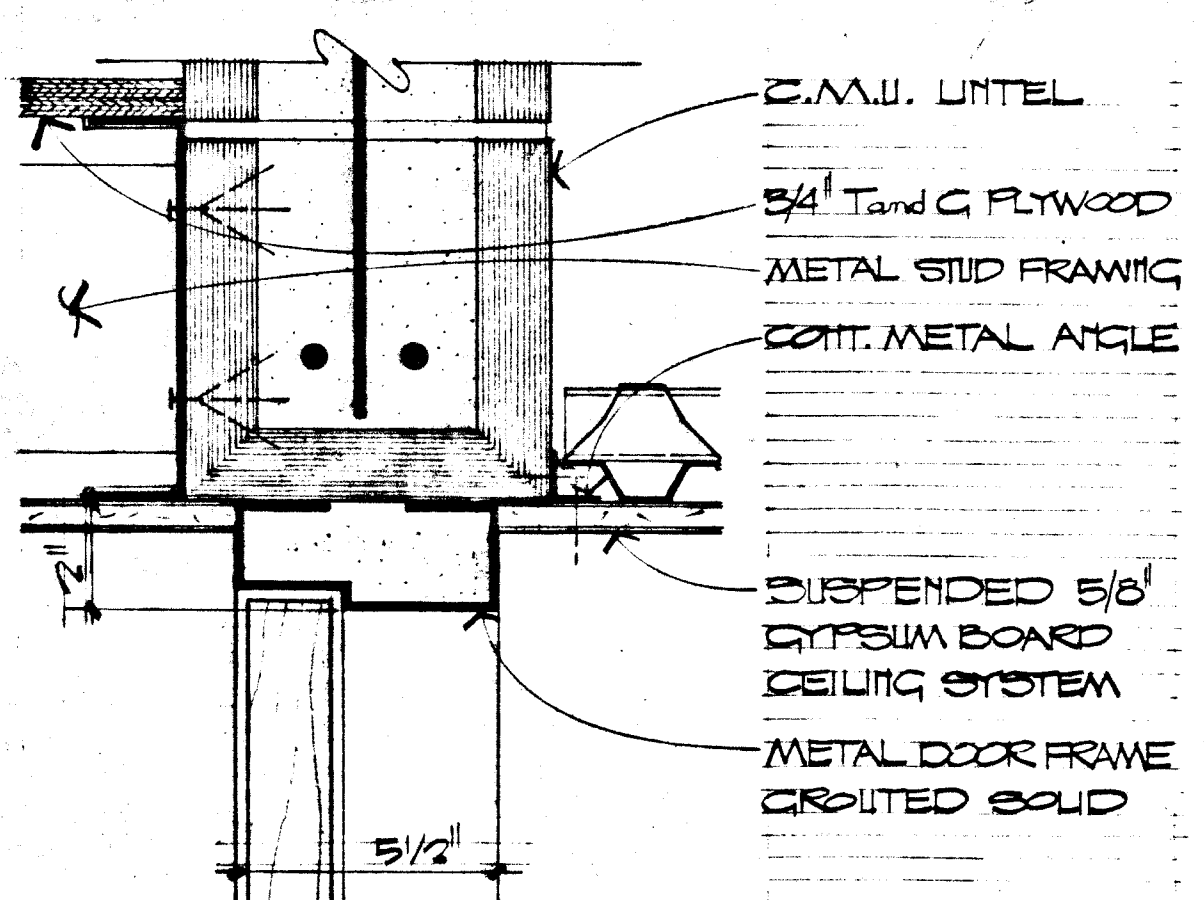

HEAD
SCALE: 8" = 1'-0"
5 A-7

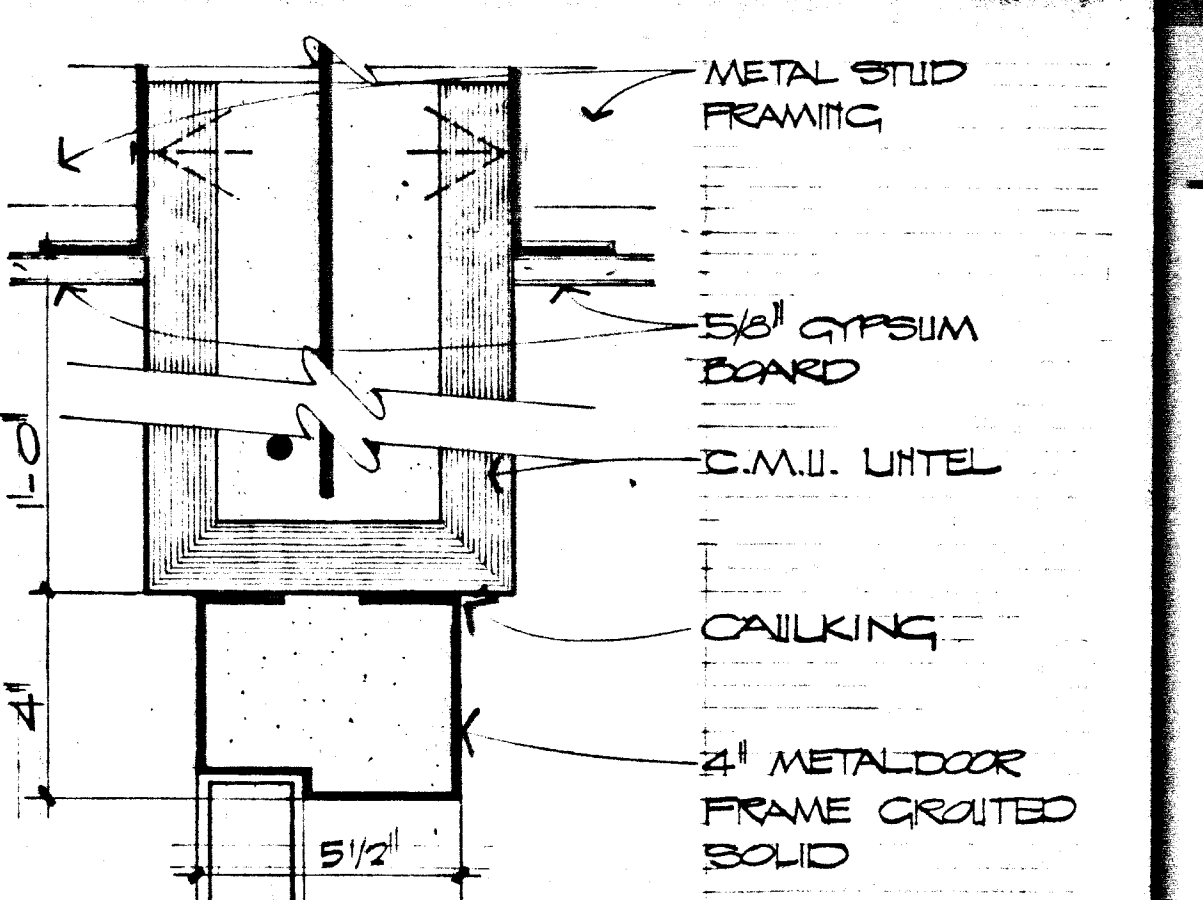

HEAD
SCALE: 8" = 1'-0"
6 A-7

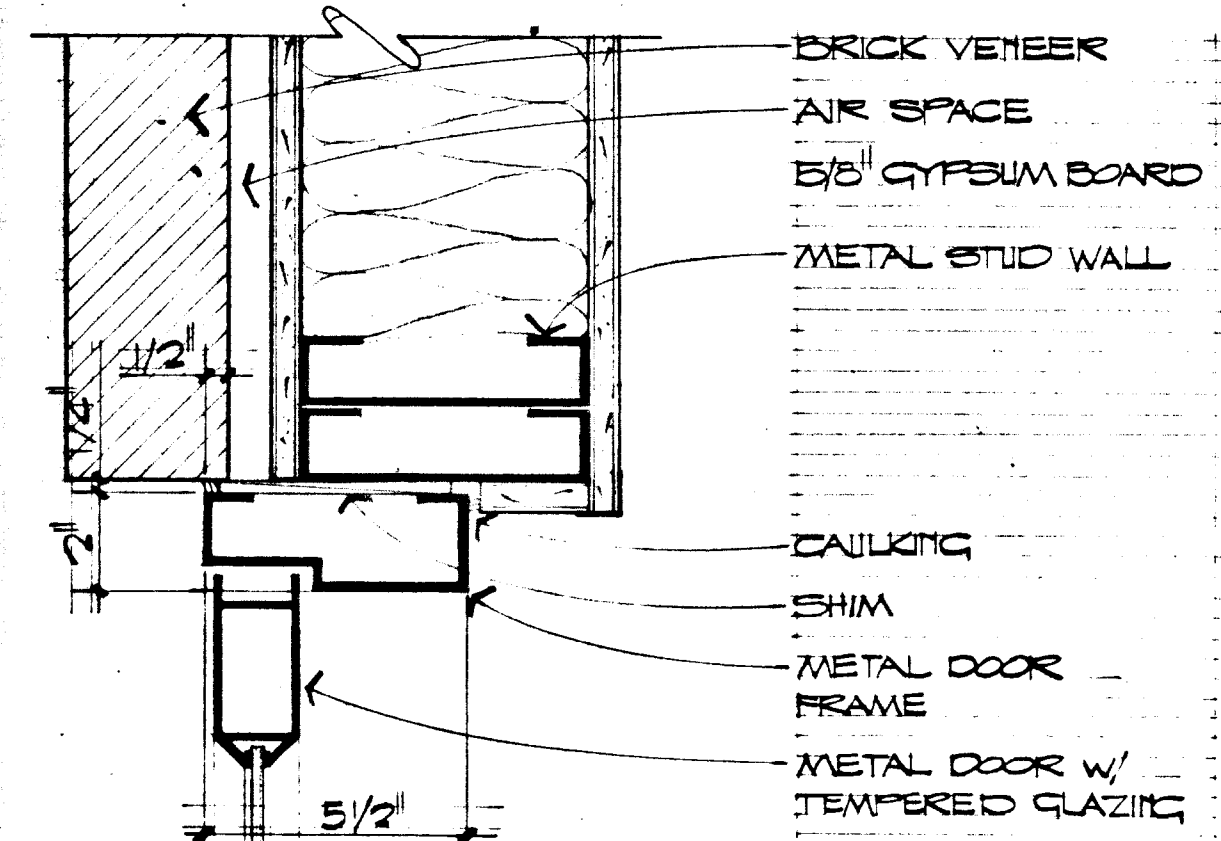

JAMB
SCALE: 8" = 1'-0"
7 A-7

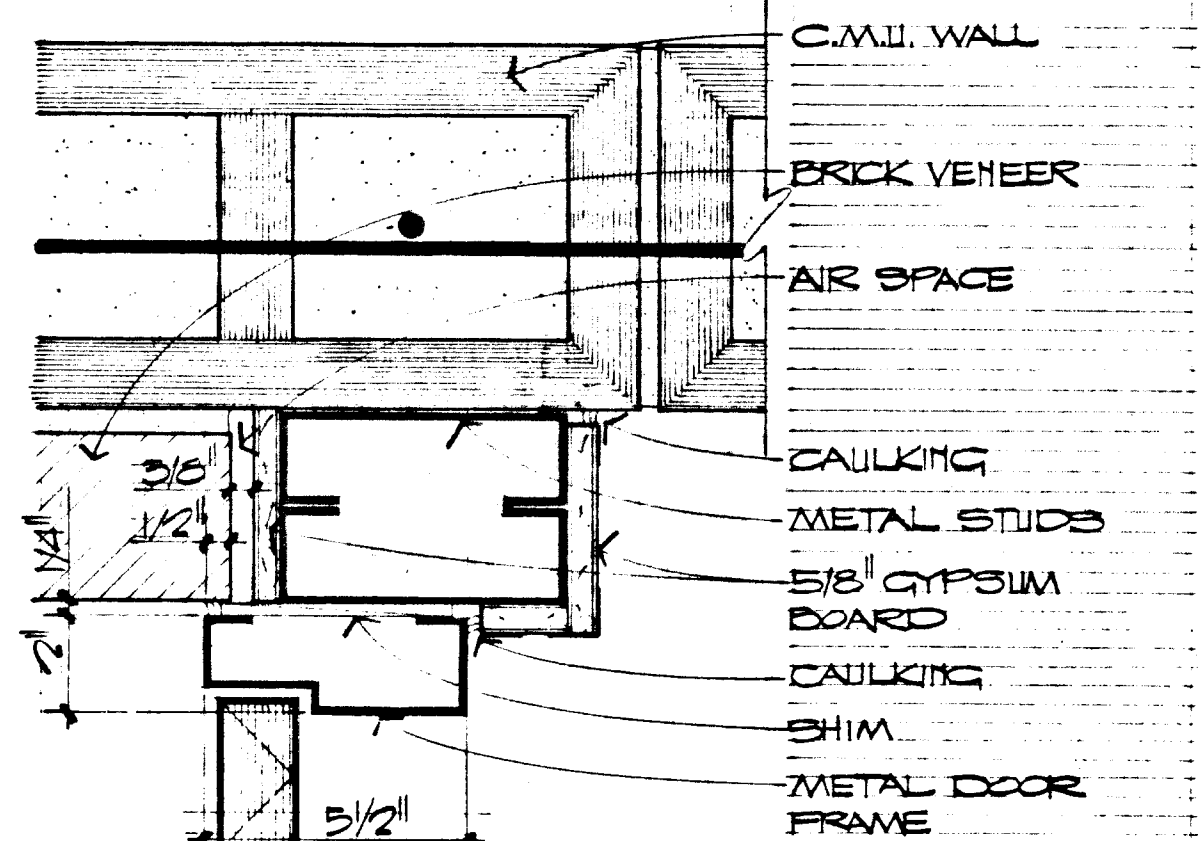

JAMB
SCALE: 8" = 1'-0"
8 A-7

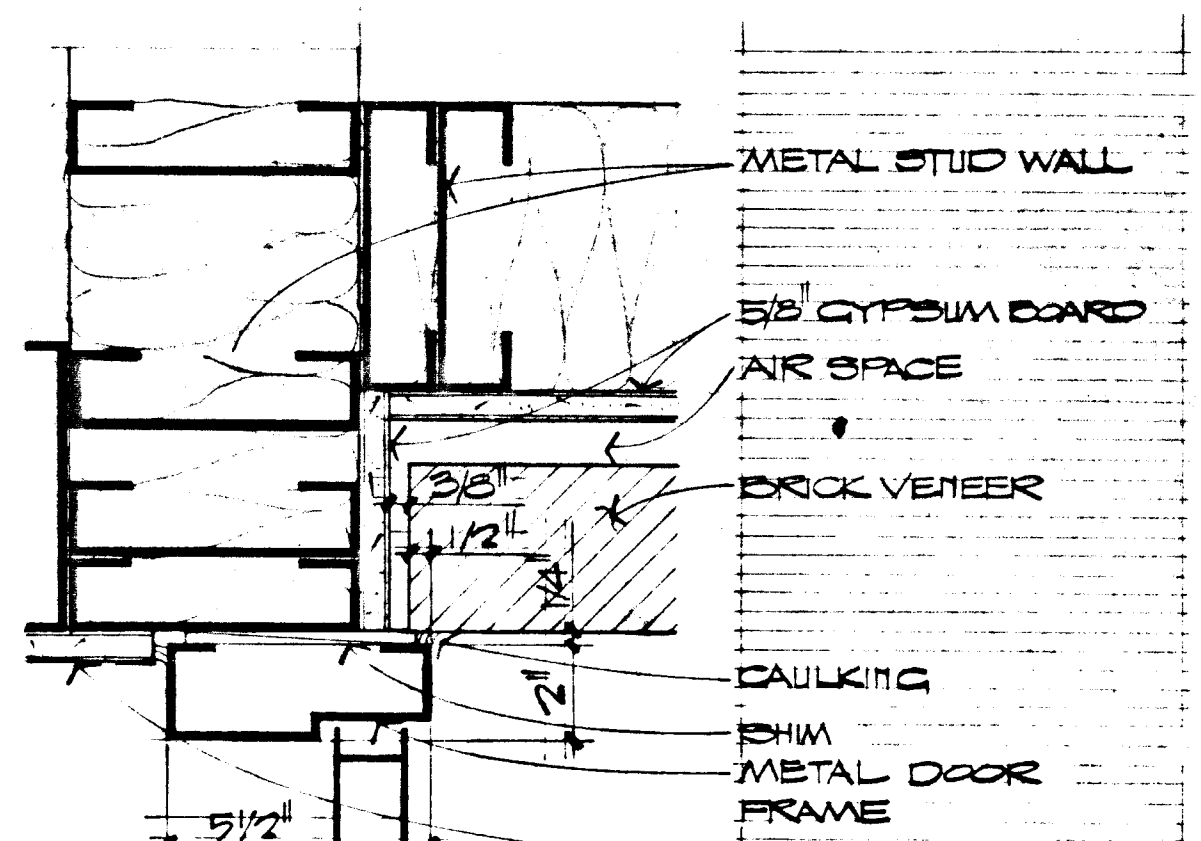

JAMB
SCALE: 8" = 1'-0"
9 A-7

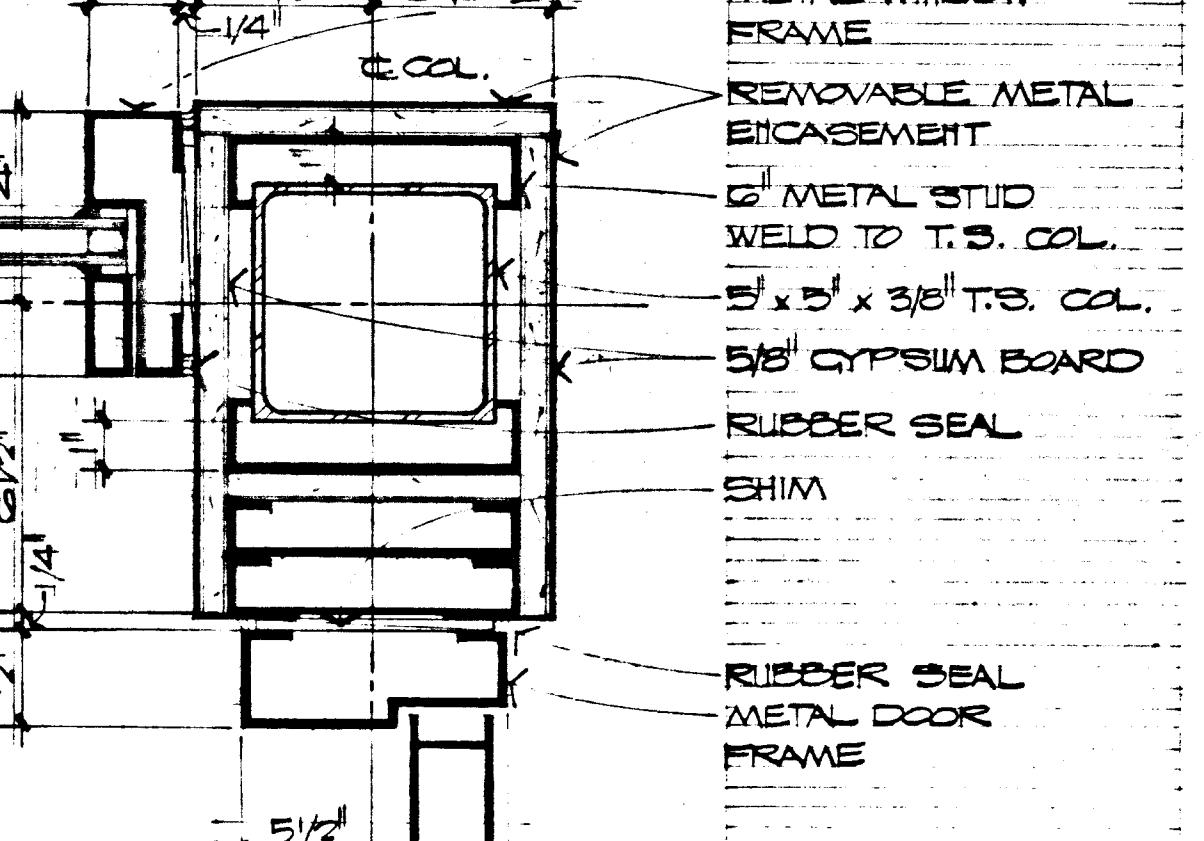

JAMB
SCALE: 8" = 1'-0"
10 A-7

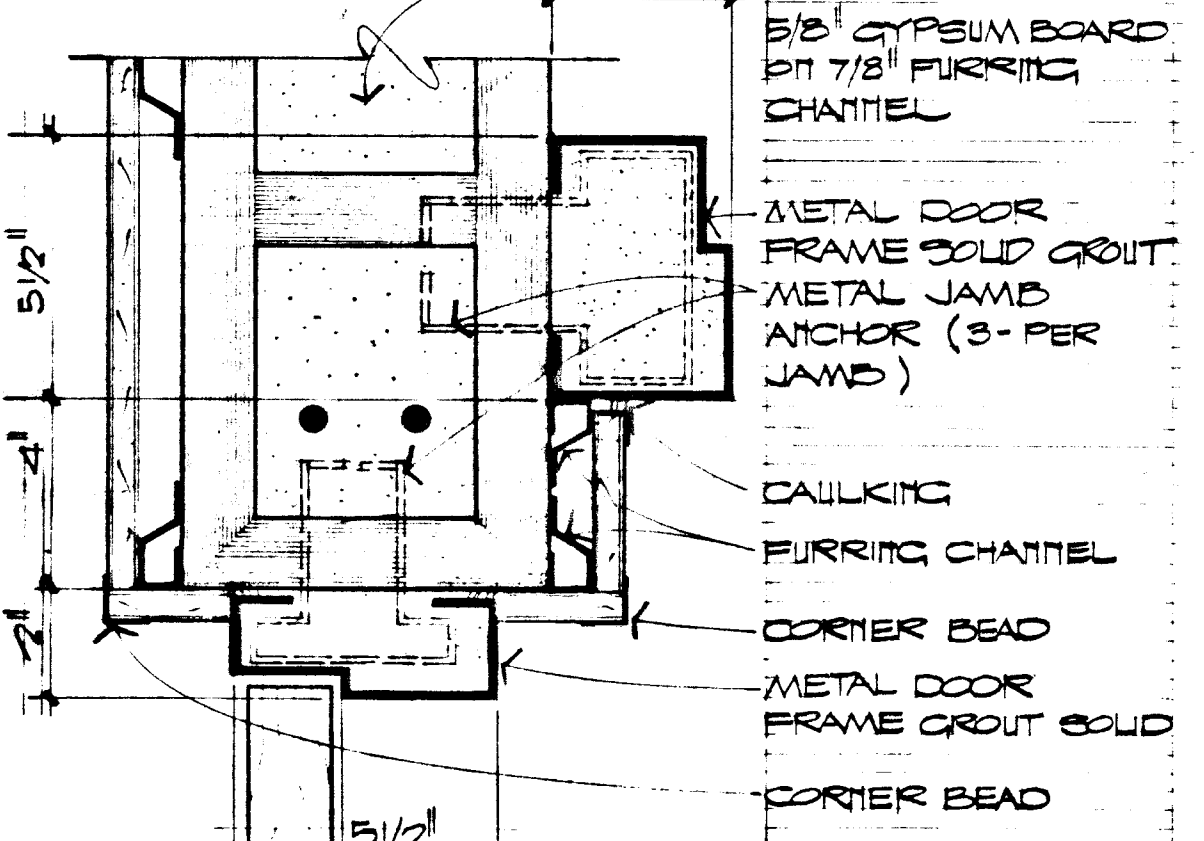

JAMB
SCALE: 8" = 1'-0"
11 A-7

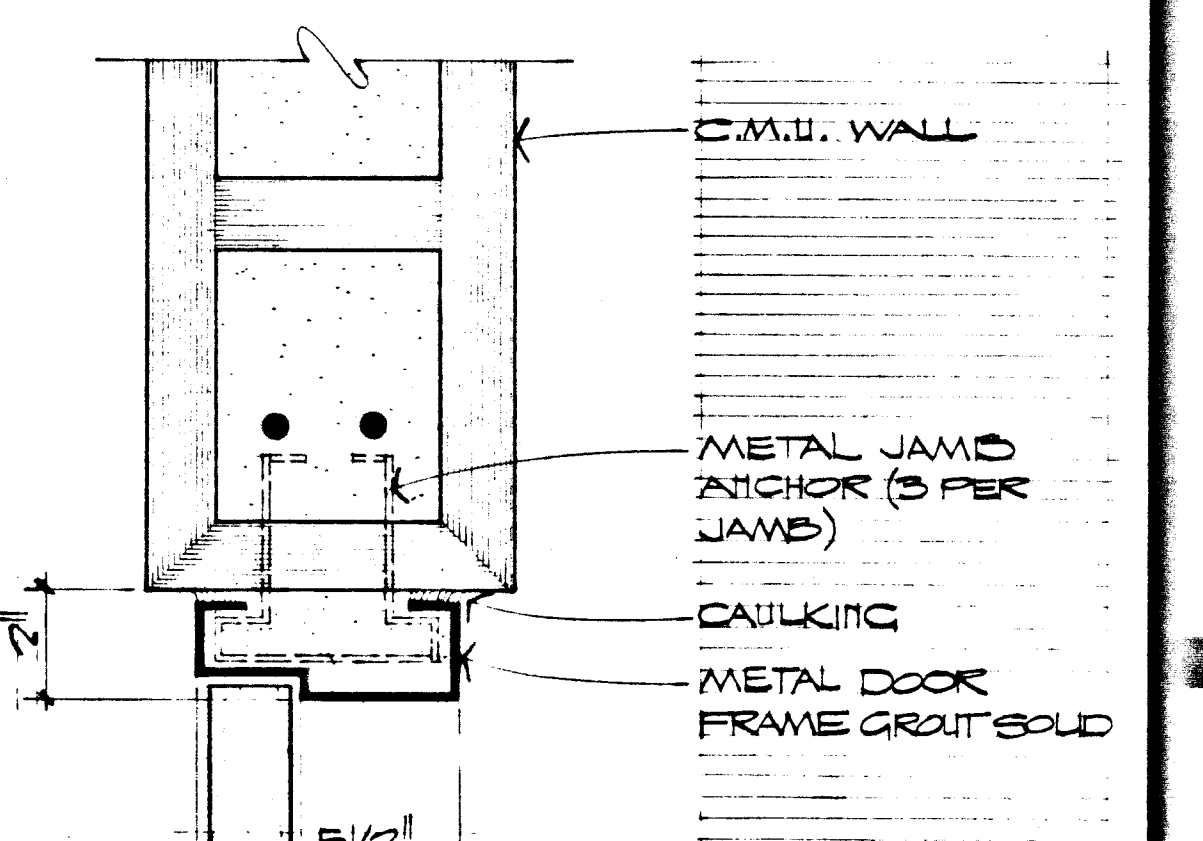

JAMB
SCALE: 8" = 1'-0"
12 A-7

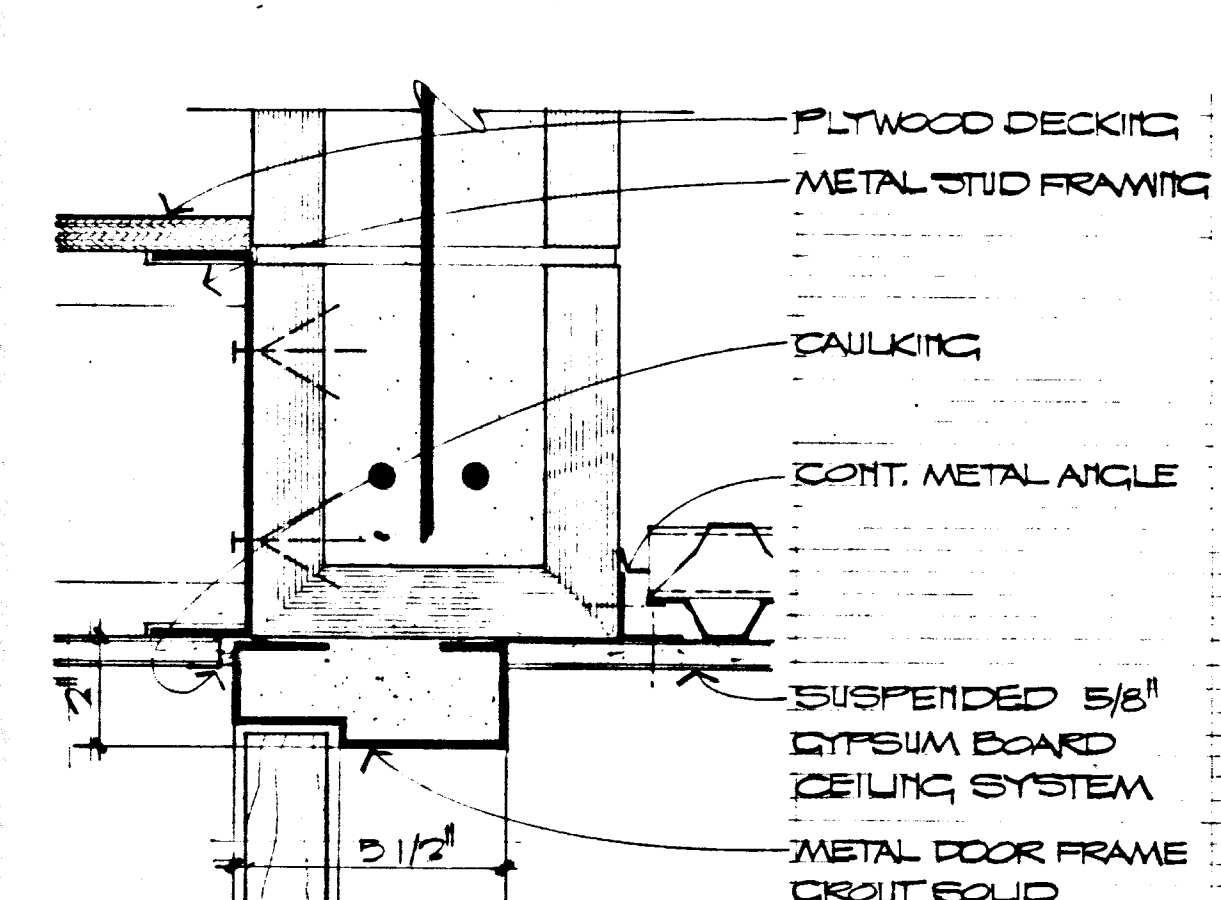

HEAD
SCALE: 8" = 1'-0"
13 A-7

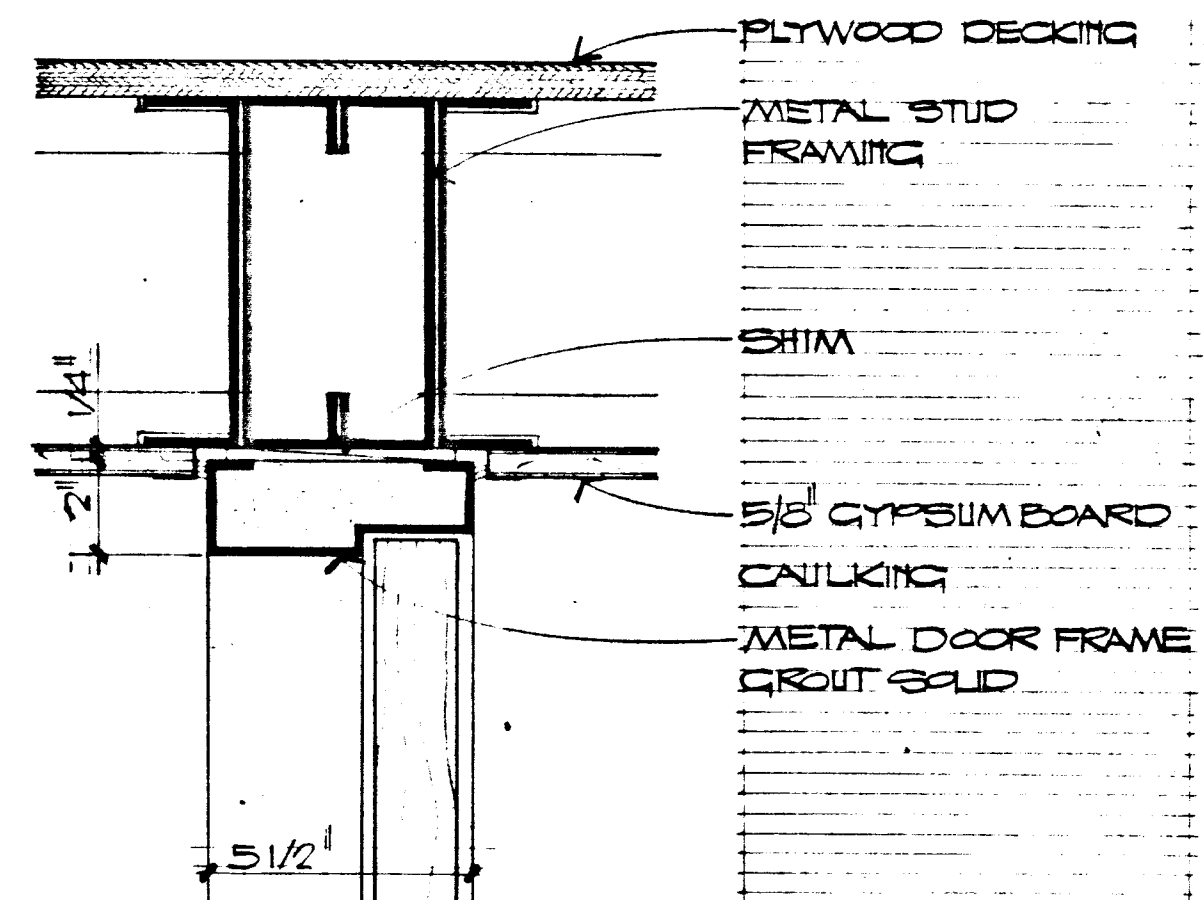

HEAD
SCALE: 8" = 1'-0"
14 A-7

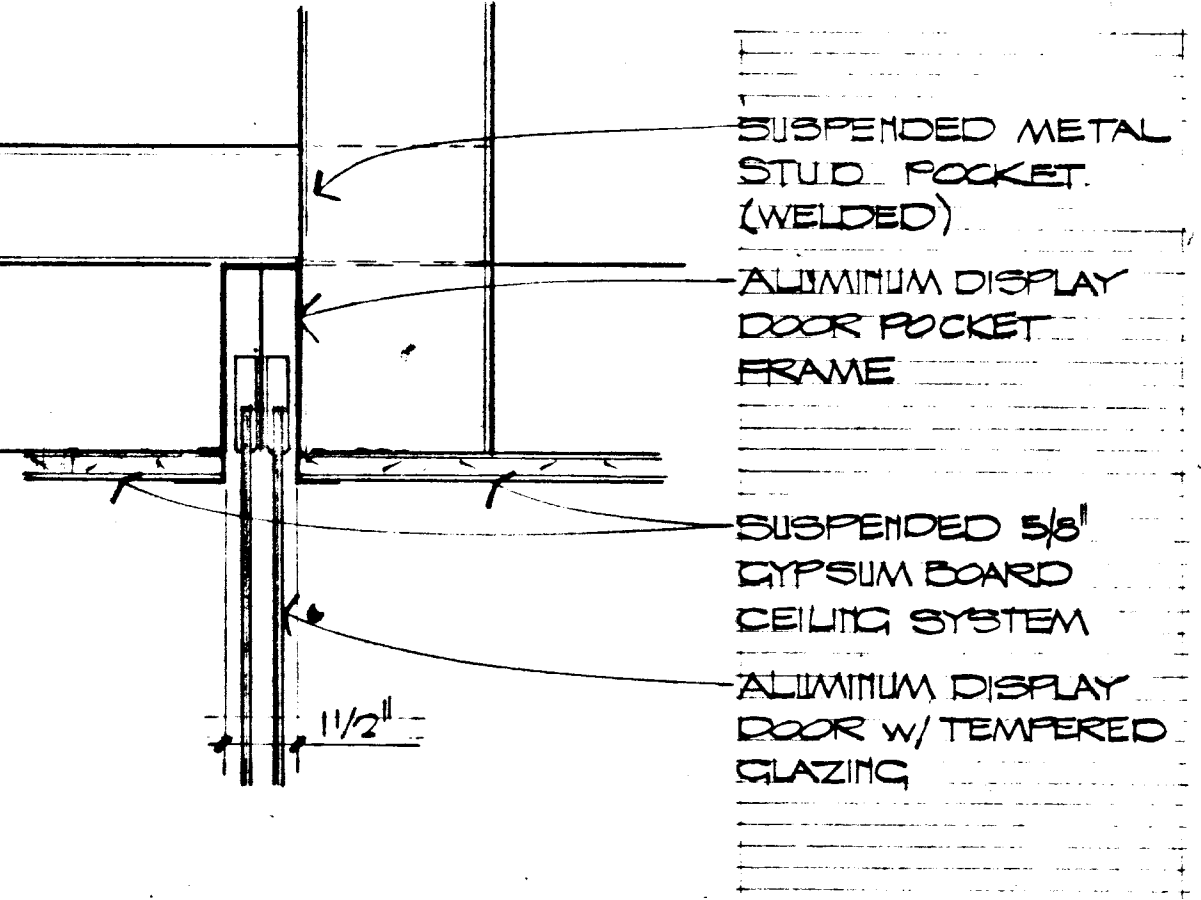

HEAD
SCALE: 8" = 1'-0"
15 A-7

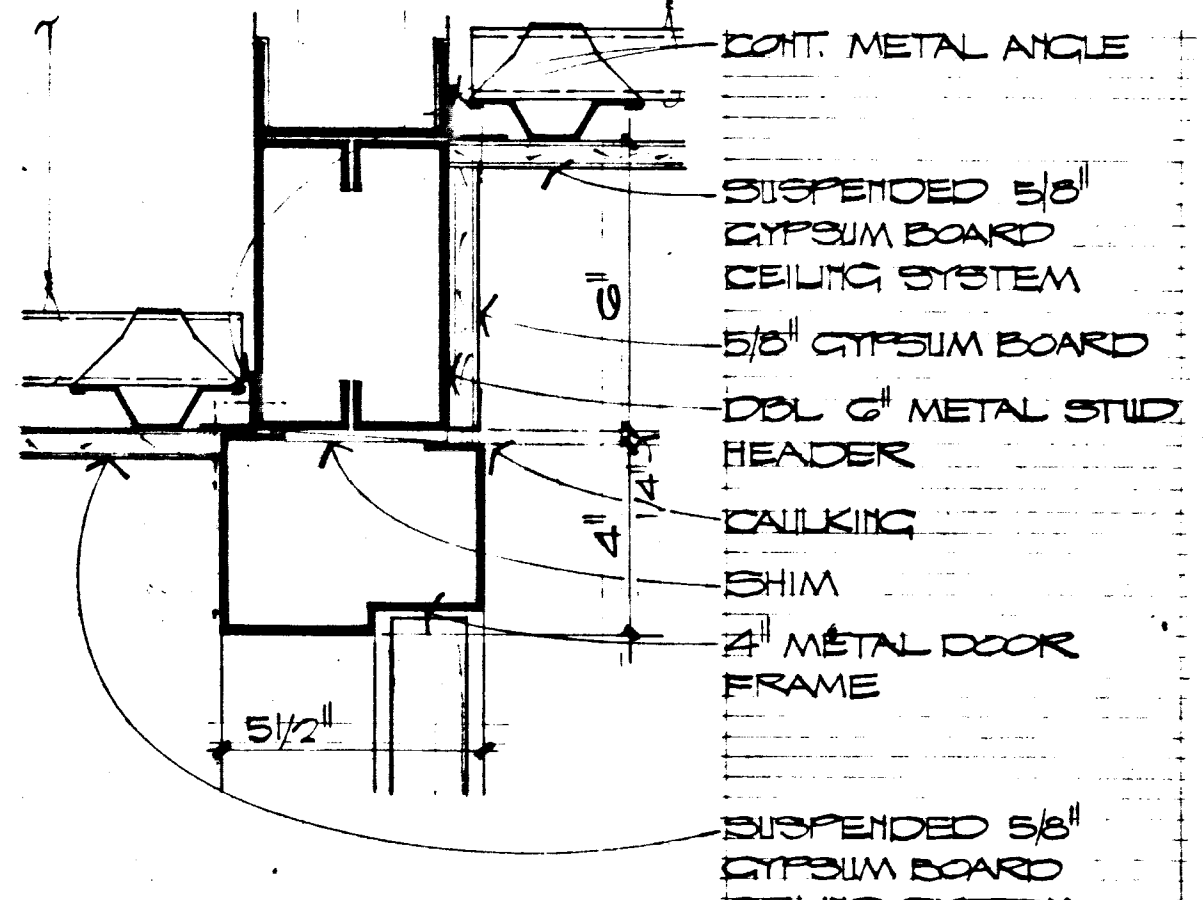

HEAD
SCALE: 8" = 1'-0"
16 A-7

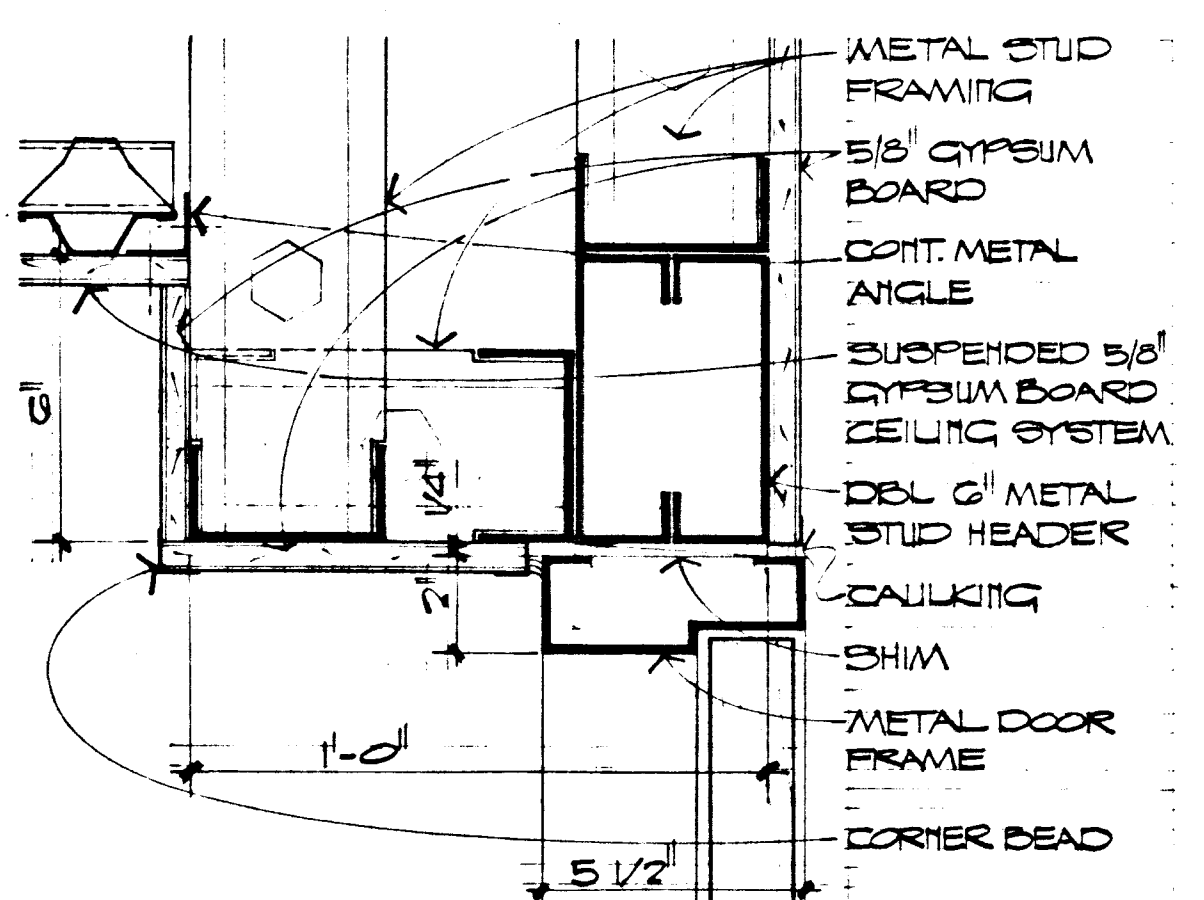

HEAD
SCALE: 8" = 1'-0"
17 A-7

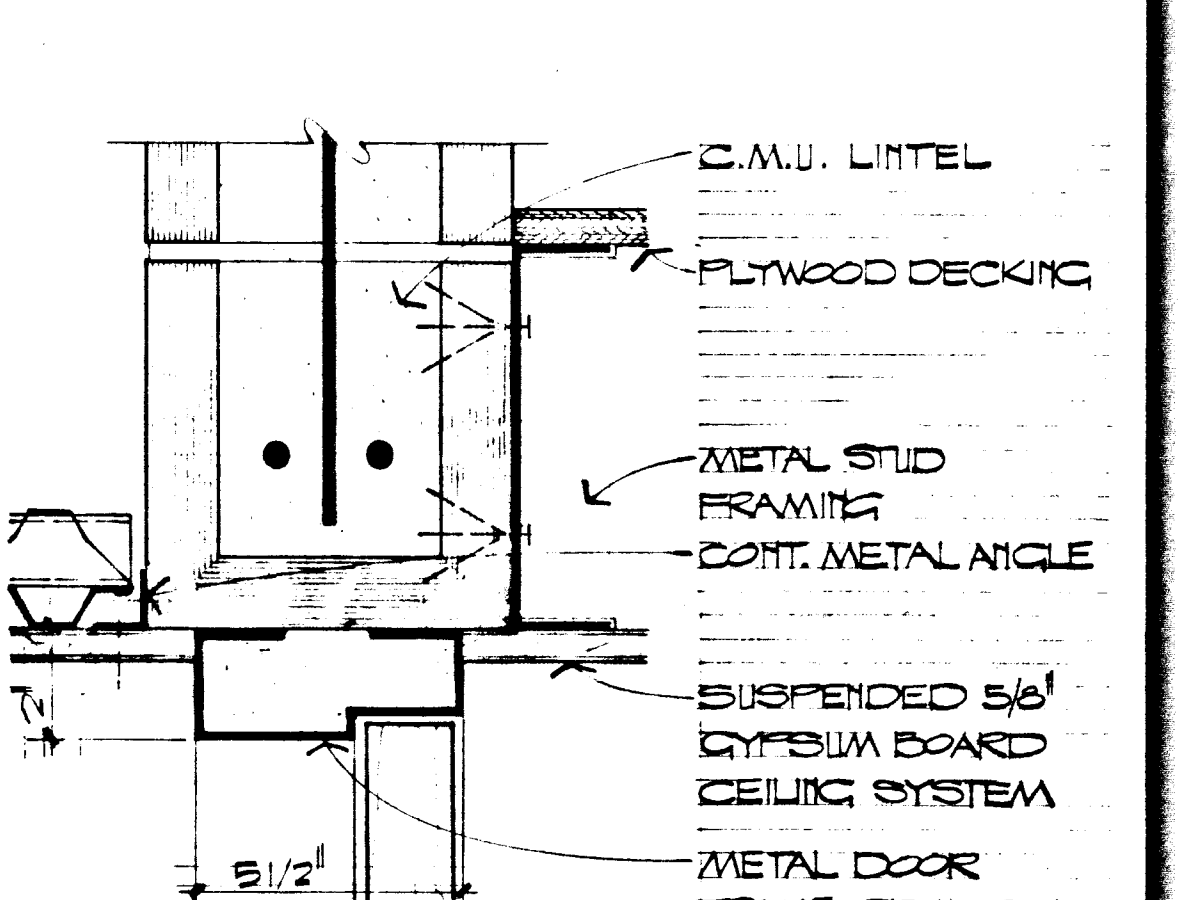

HEAD
SCALE: 8" = 1'-0"
18 A-7

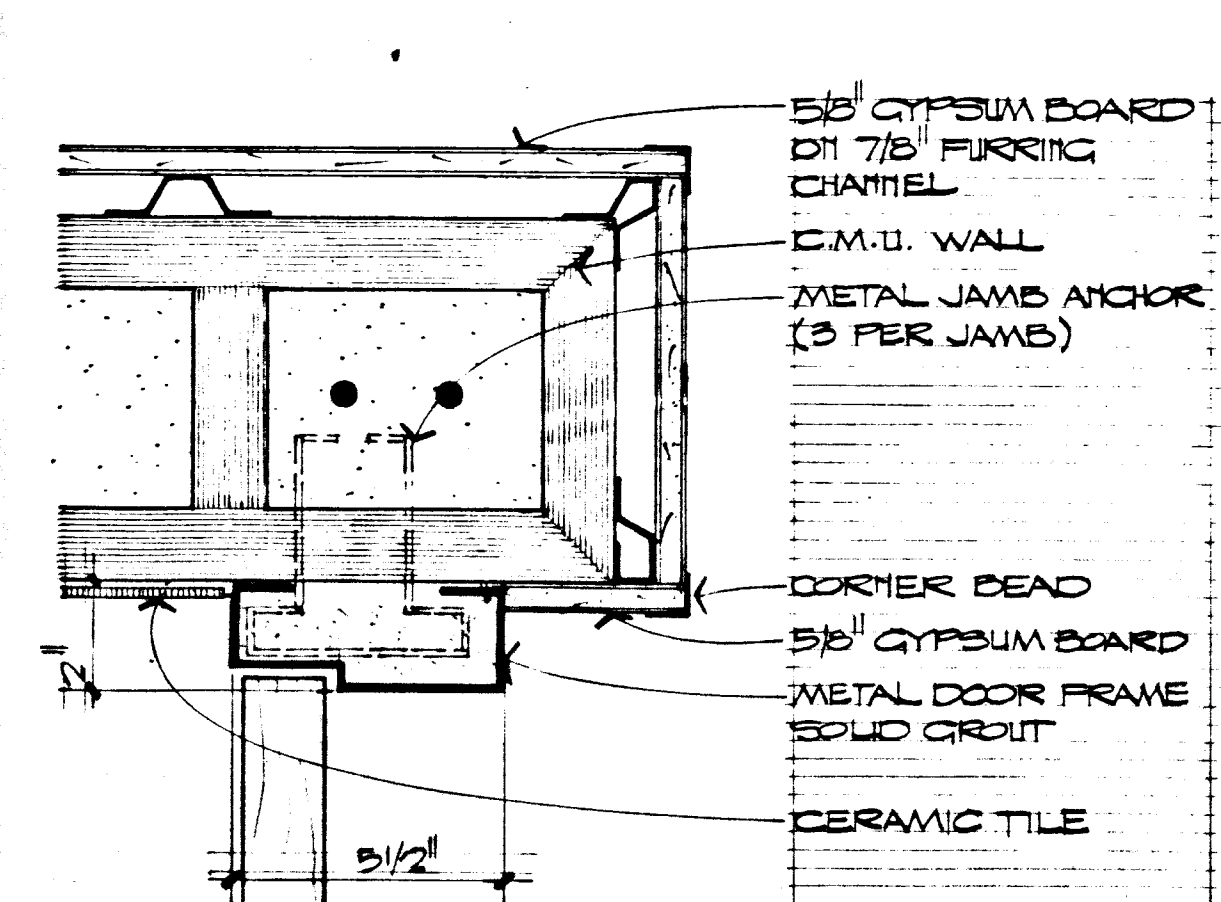

JAMB
SCALE: 8" = 1'-0"
19 A-7

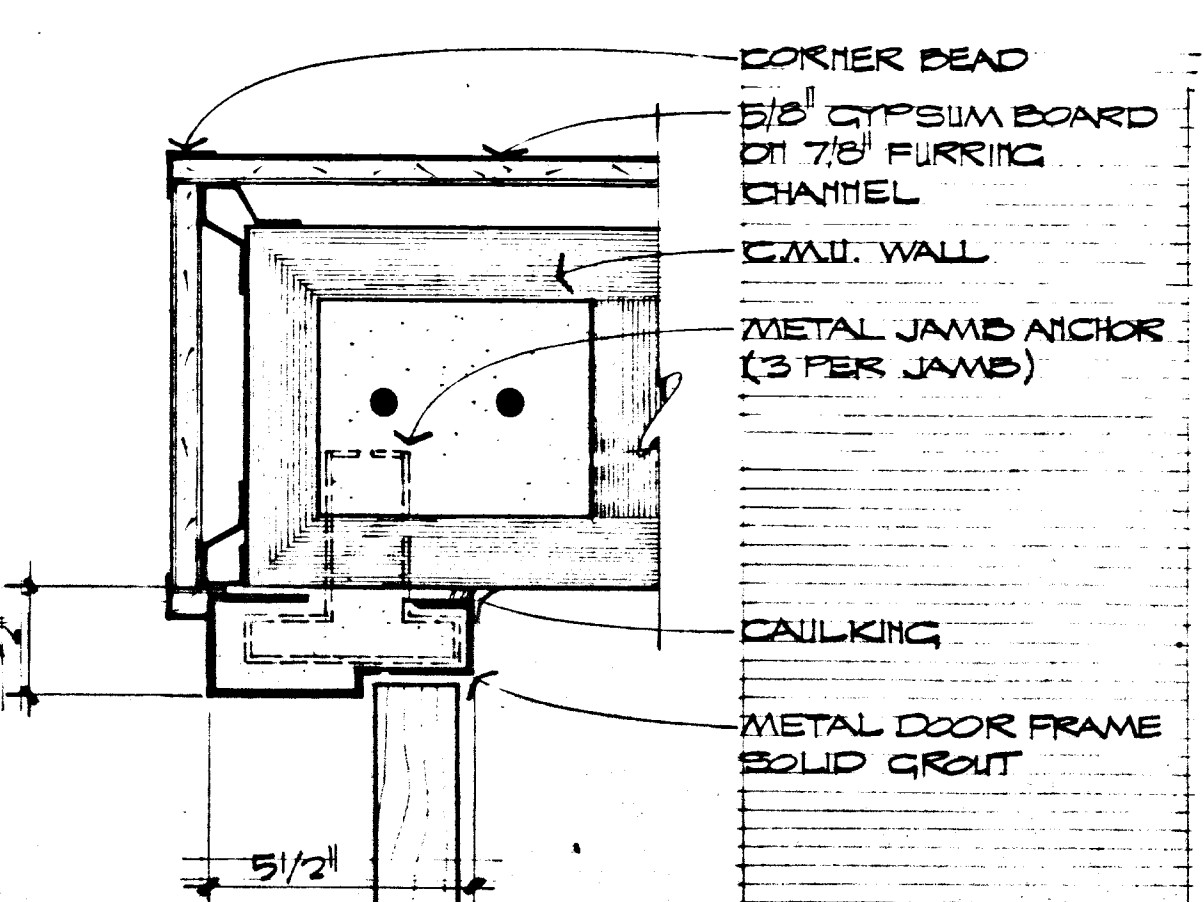

JAMB
SCALE: 8" = 1'-0"
20 A-7

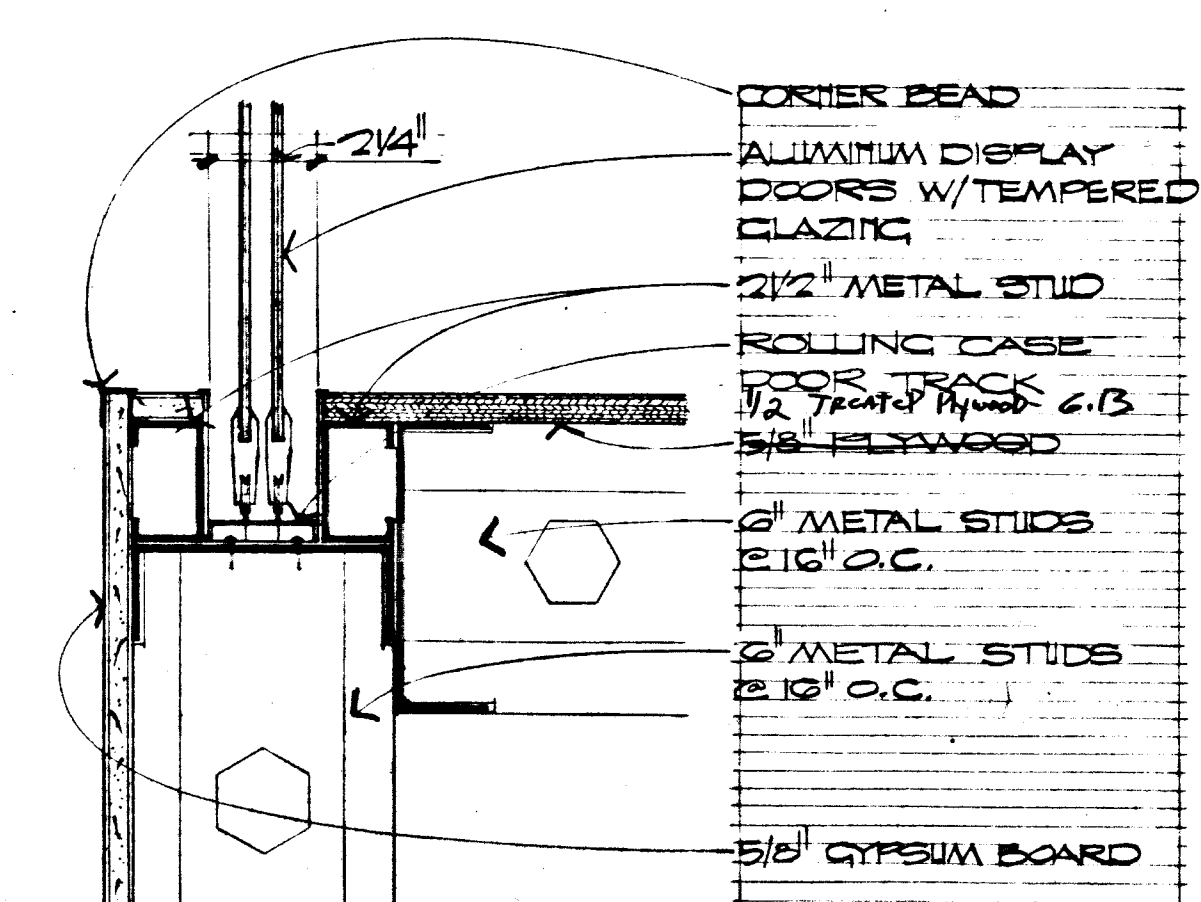

SILL
SCALE: 8" = 1'-0"
21 A-7

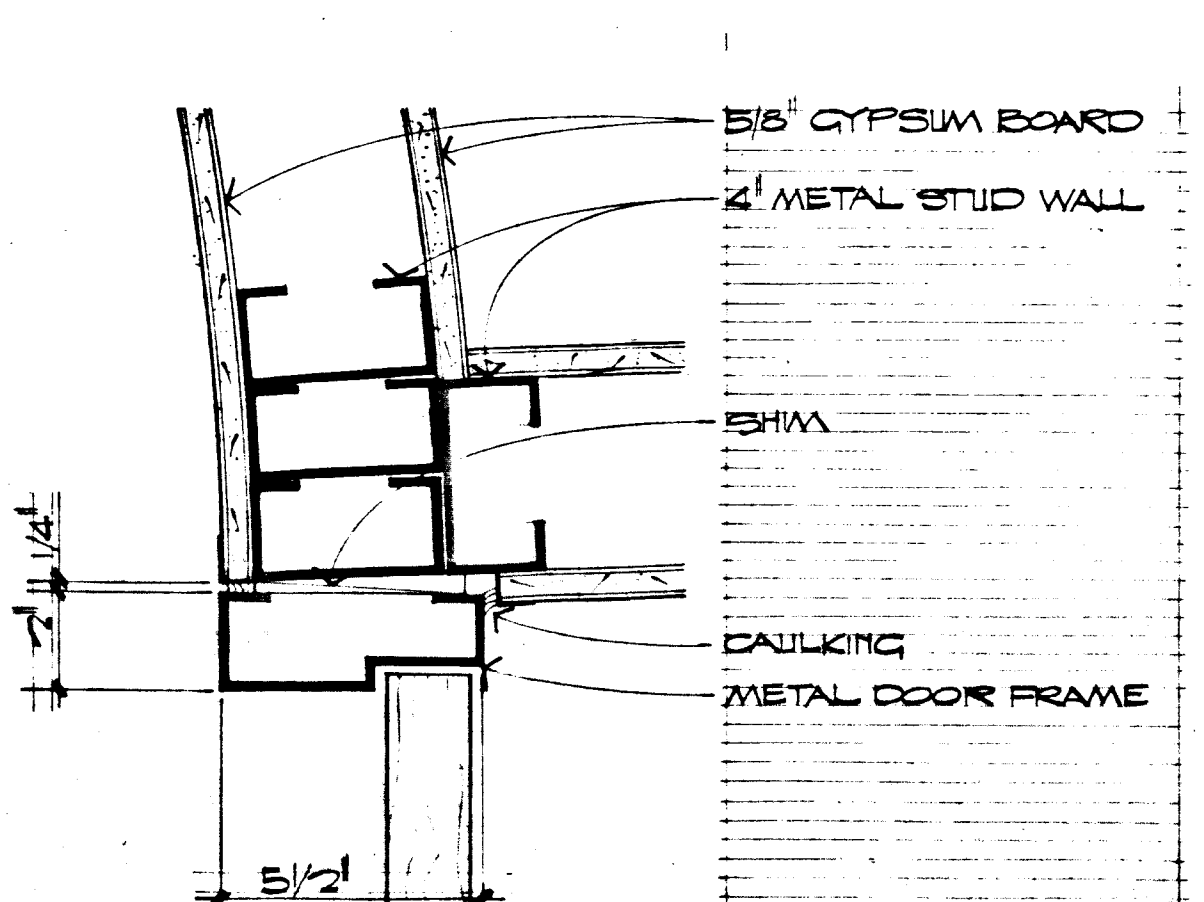

JAMB
SCALE: 8" = 1'-0"
22 A-7

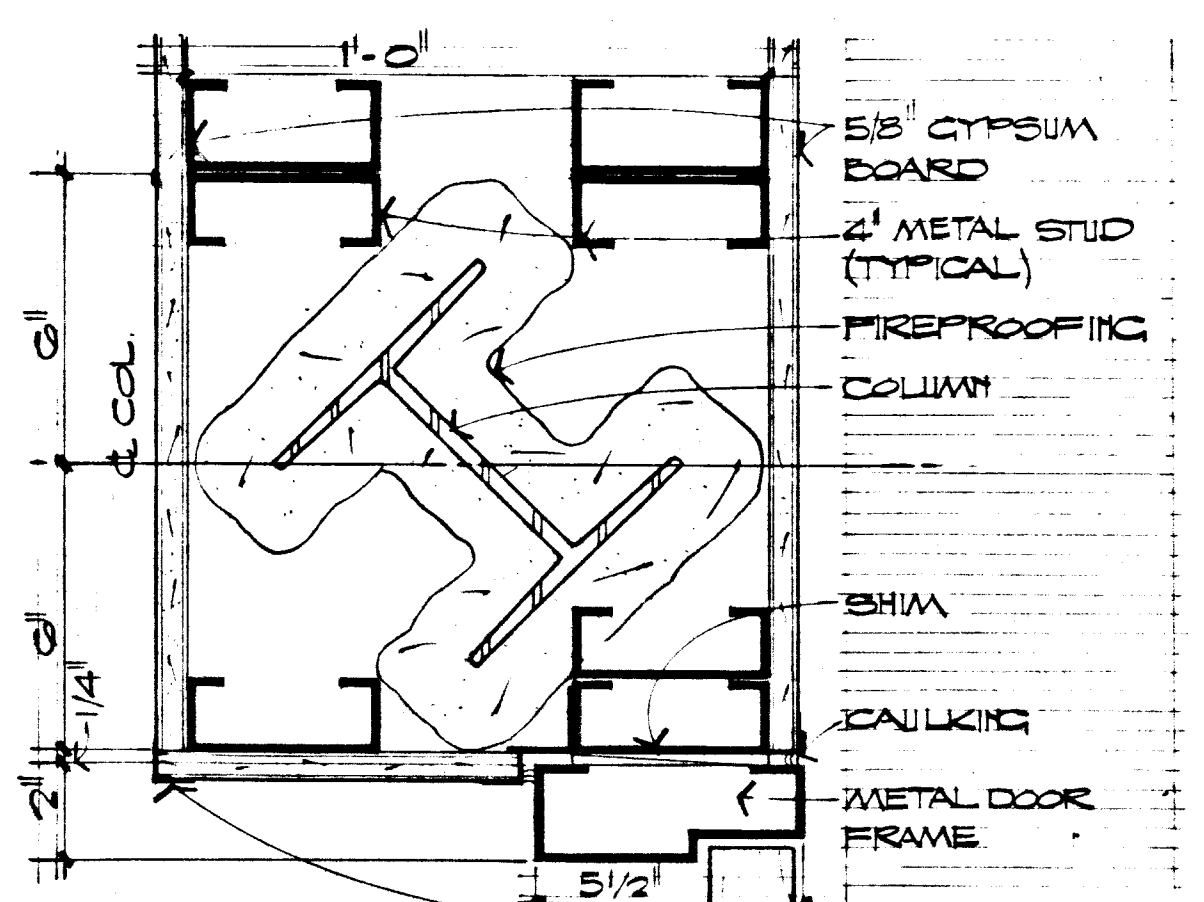

JAMB
SCALE: 8" = 1'-0"
23 A-7

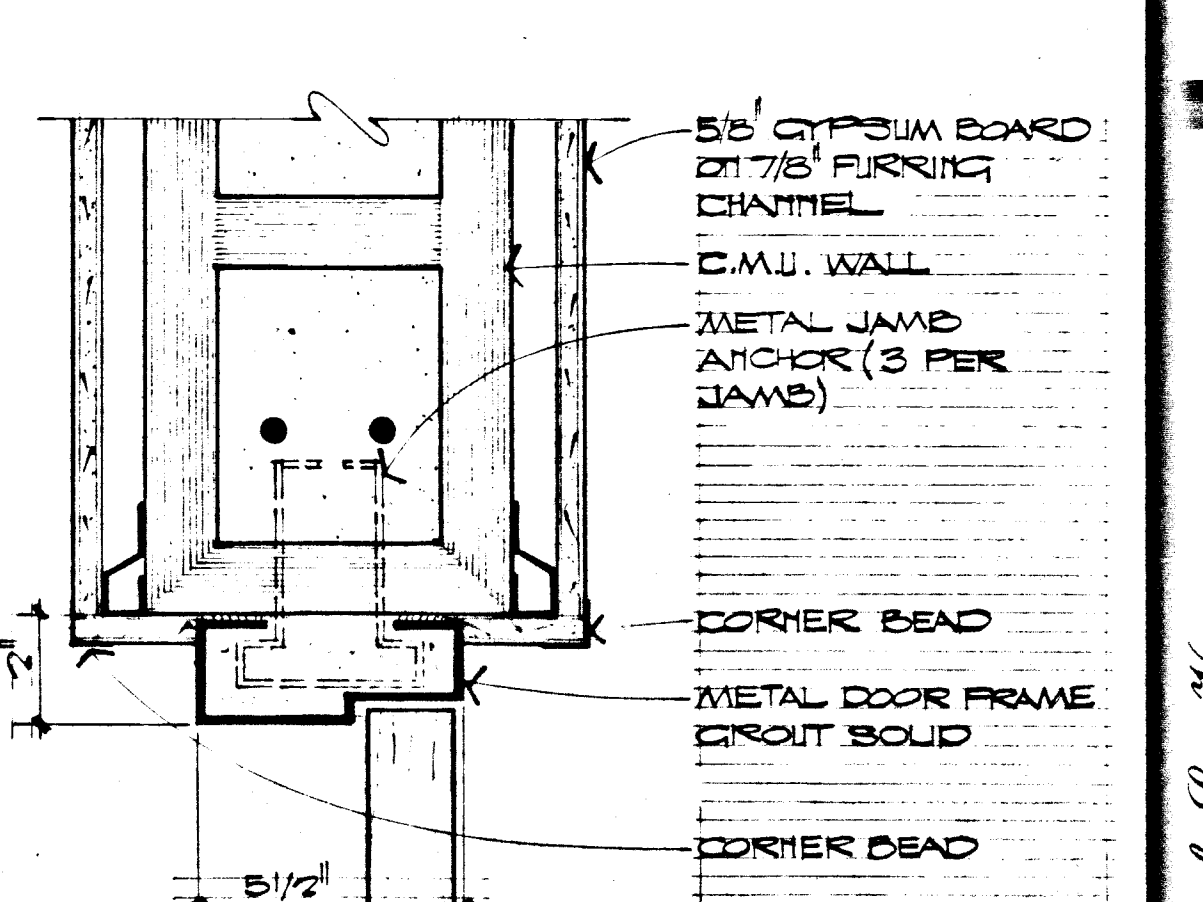

JAMB
SCALE: 8" = 1'-0"
24 A-7

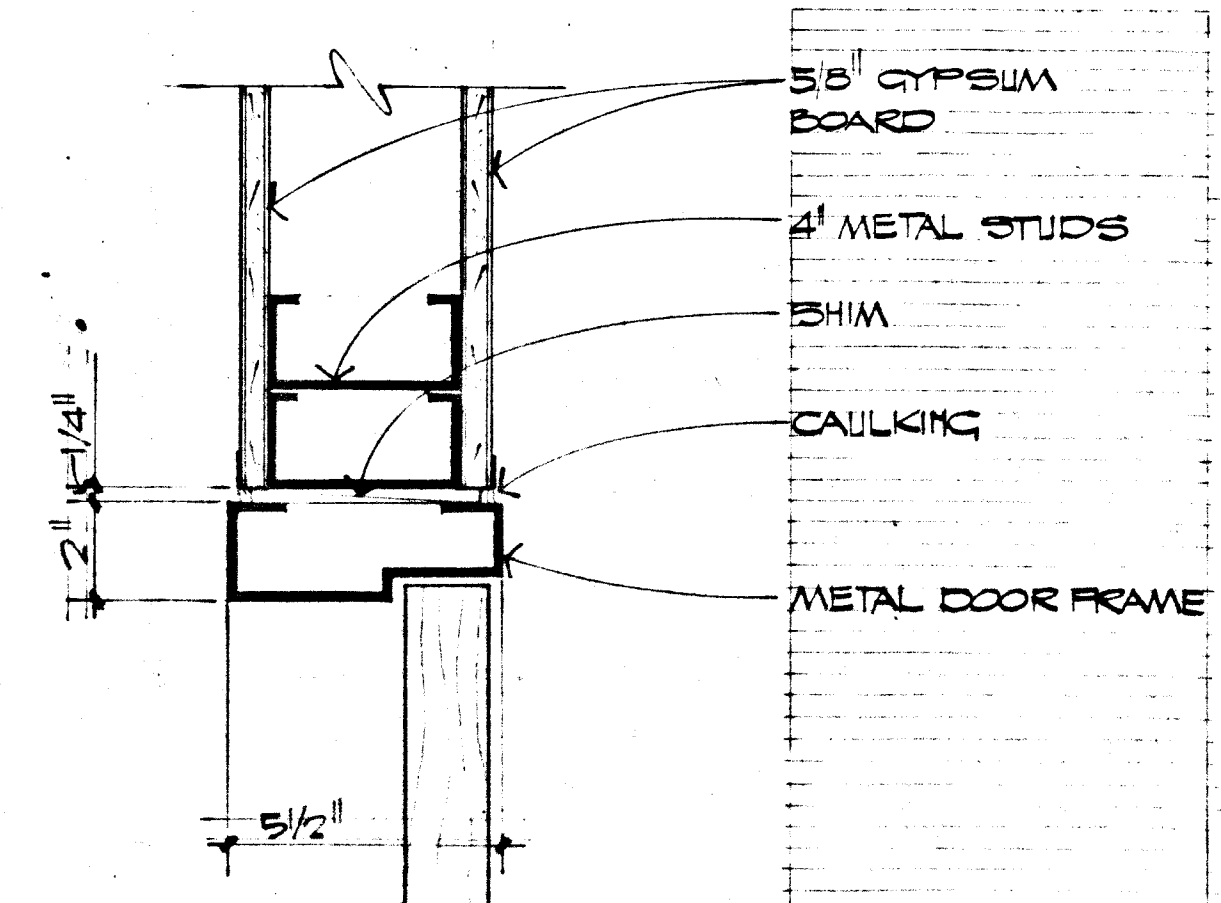

JAMB
SCALE: 8" = 1'-0"
25 A-7

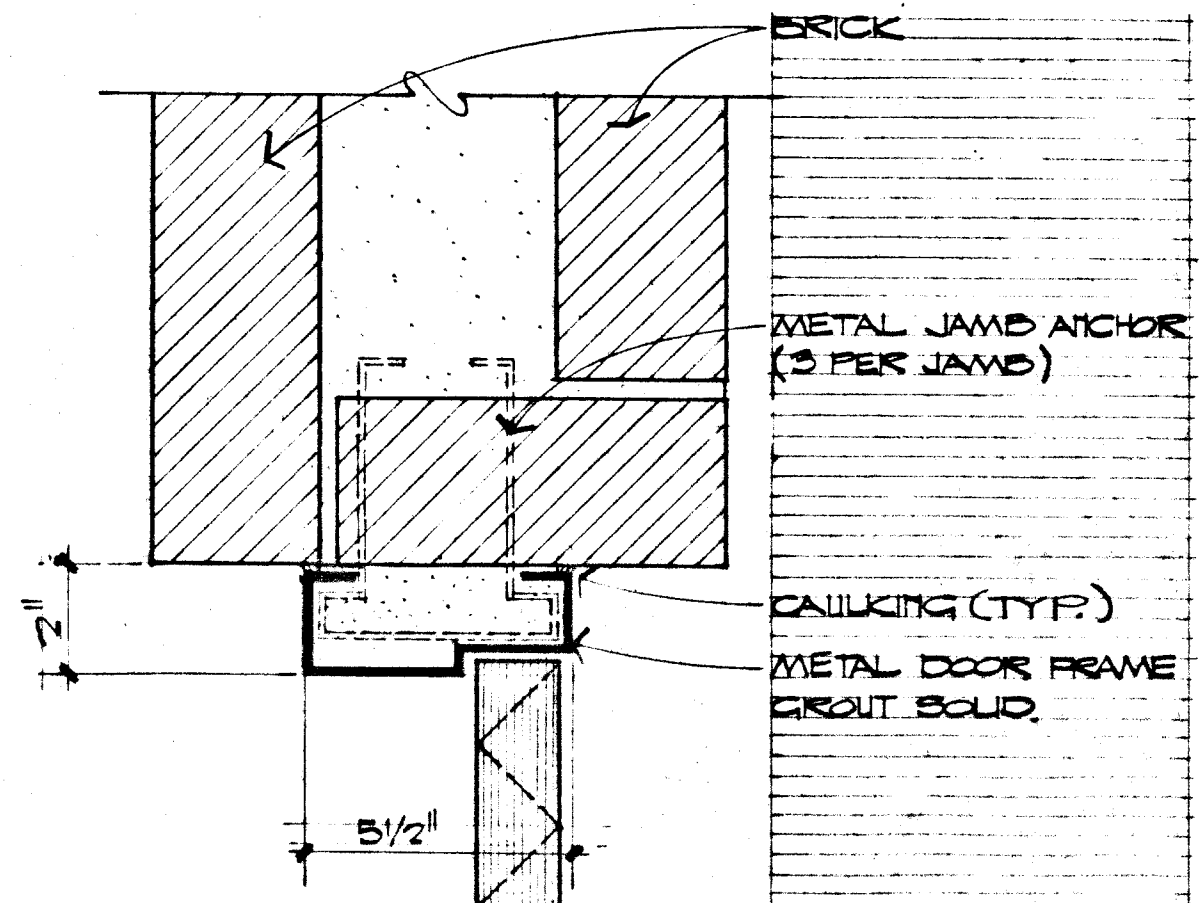

JAMB
SCALE: 8" = 1'-0"
26 A-7

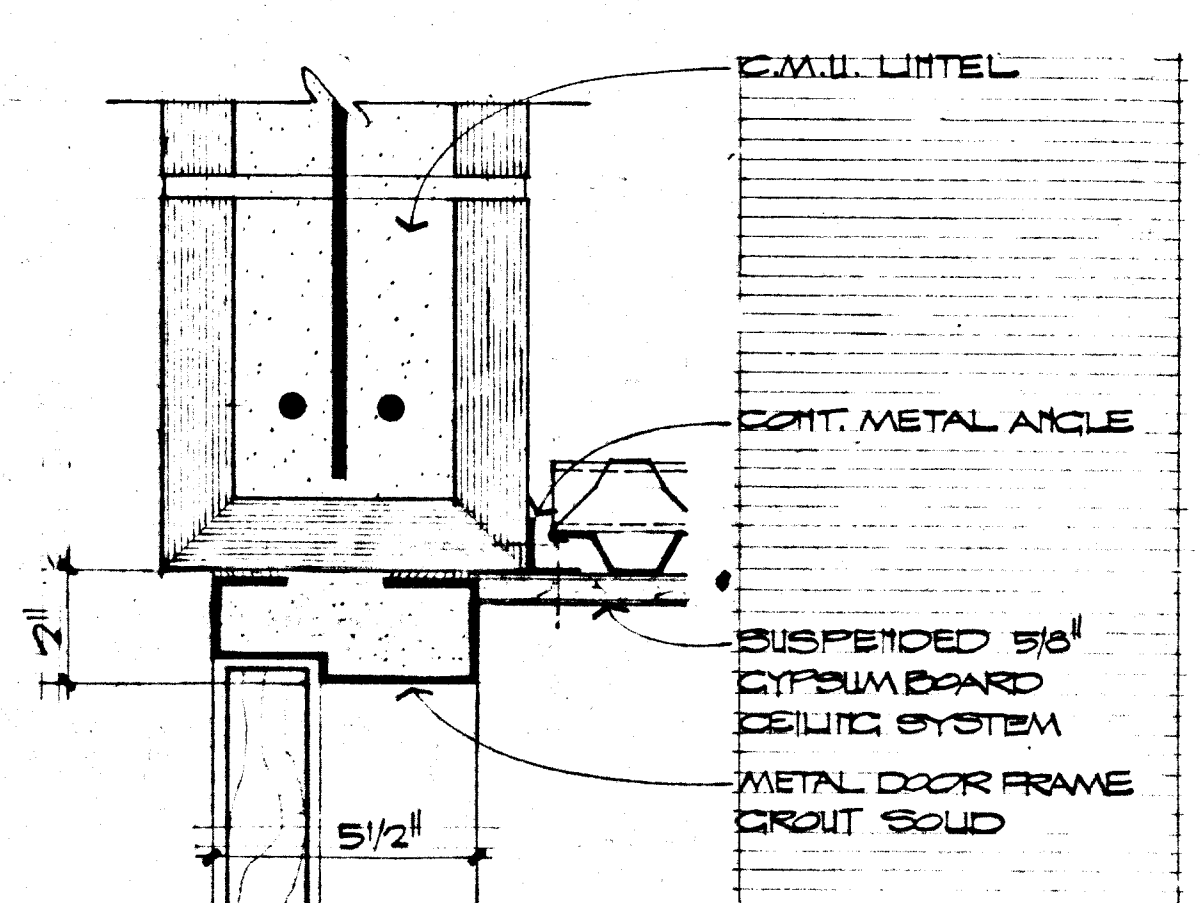

HEAD
SCALE: 8" = 1'-0"
27 A-7

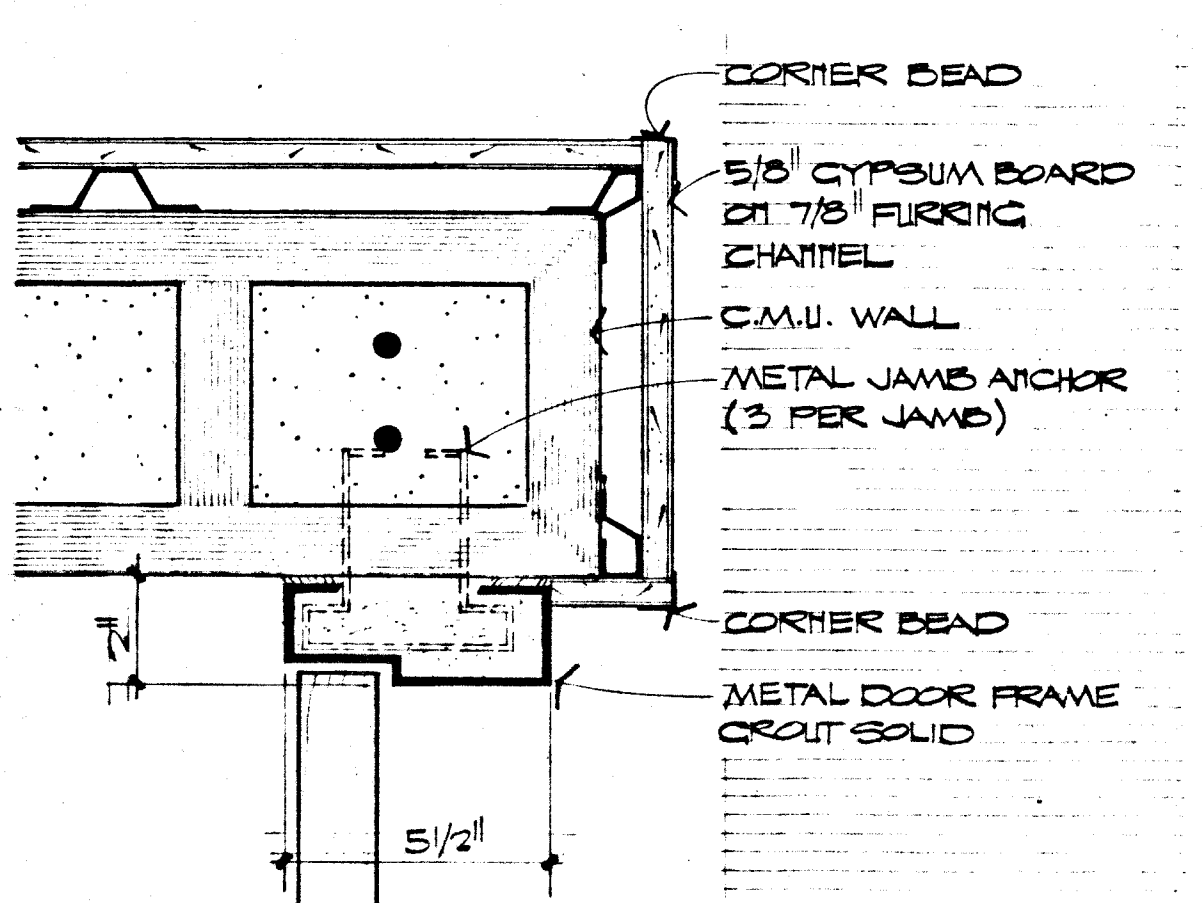

JAMB
SCALE: 8" = 1'-0"
28 A-7

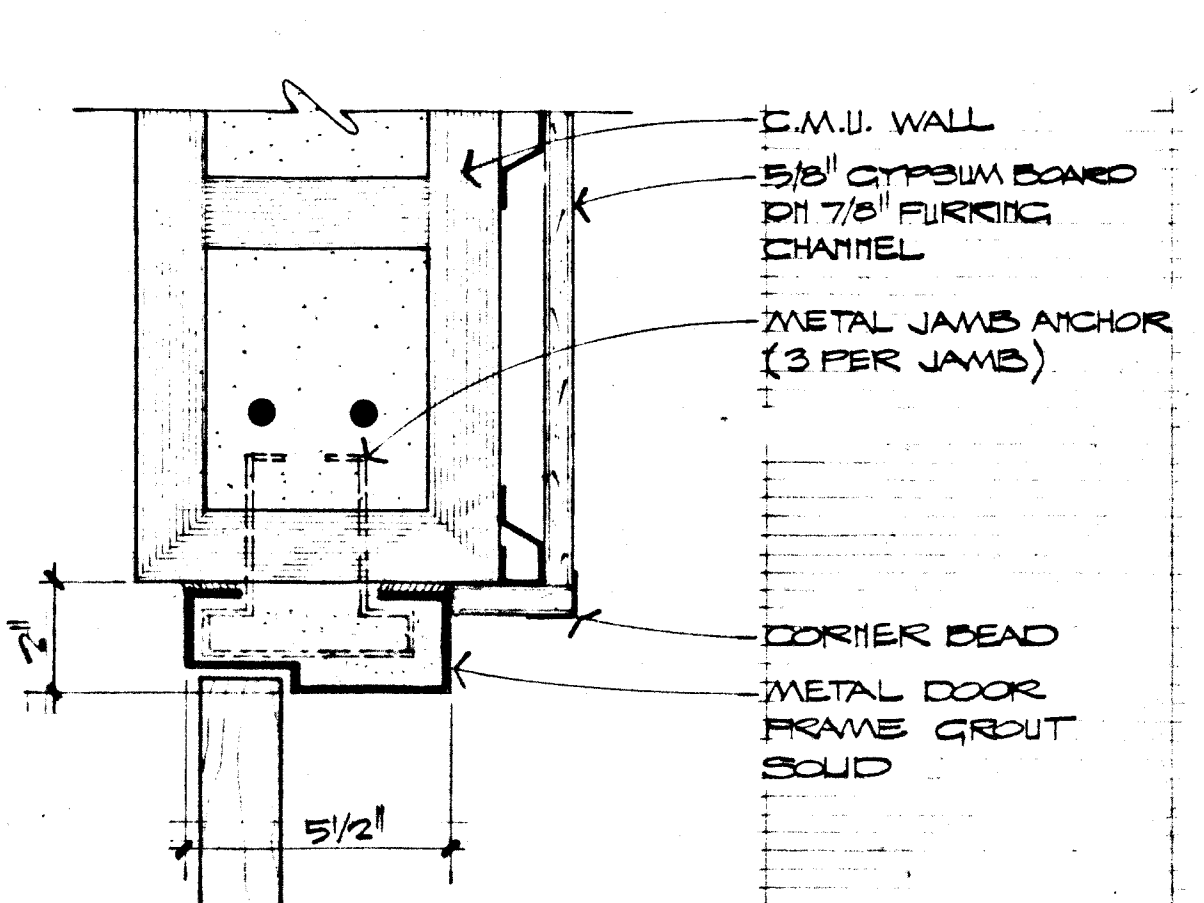

JAMB
SCALE: 8" = 1'-0"
29 A-7

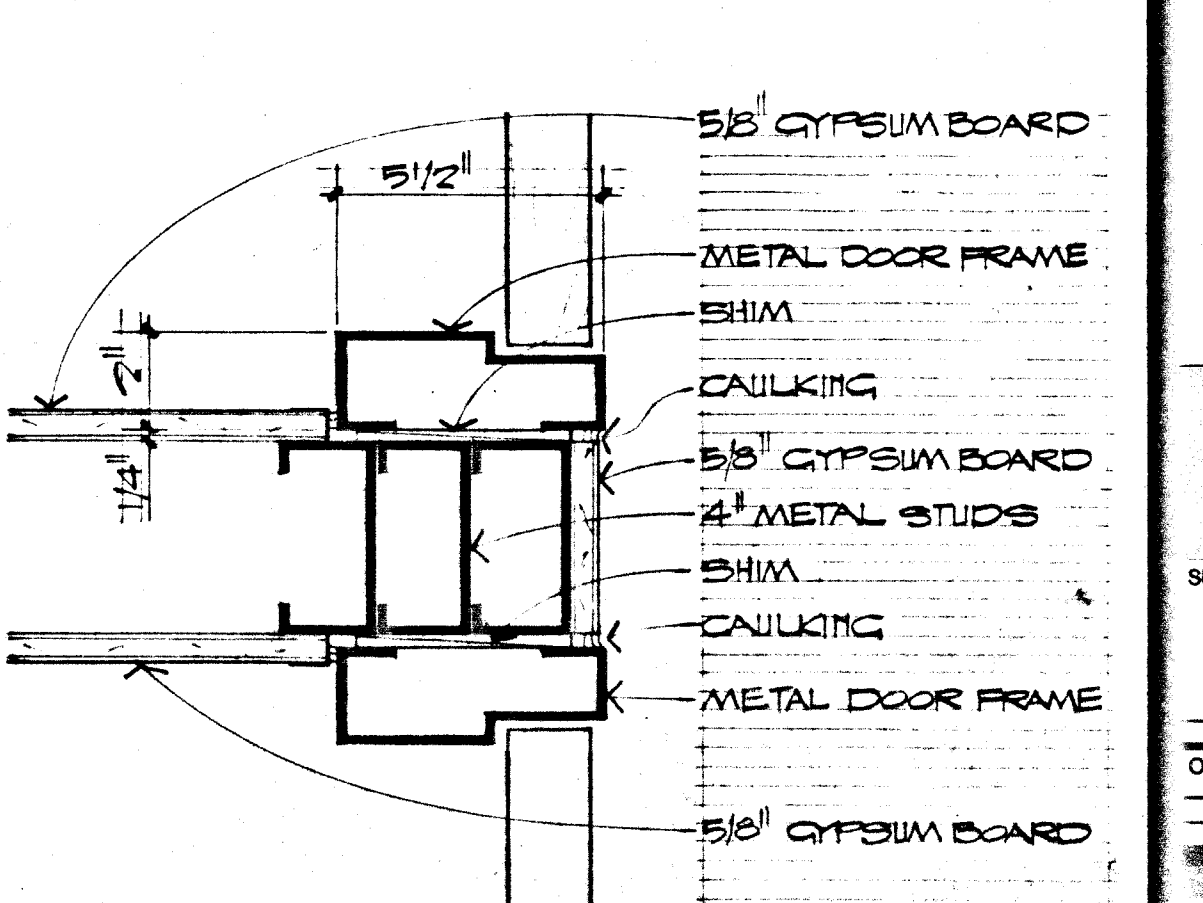

JAMB
SCALE: 8" = 1'-0"
30 A-7