

MANUAL DRAIN VALVE

12

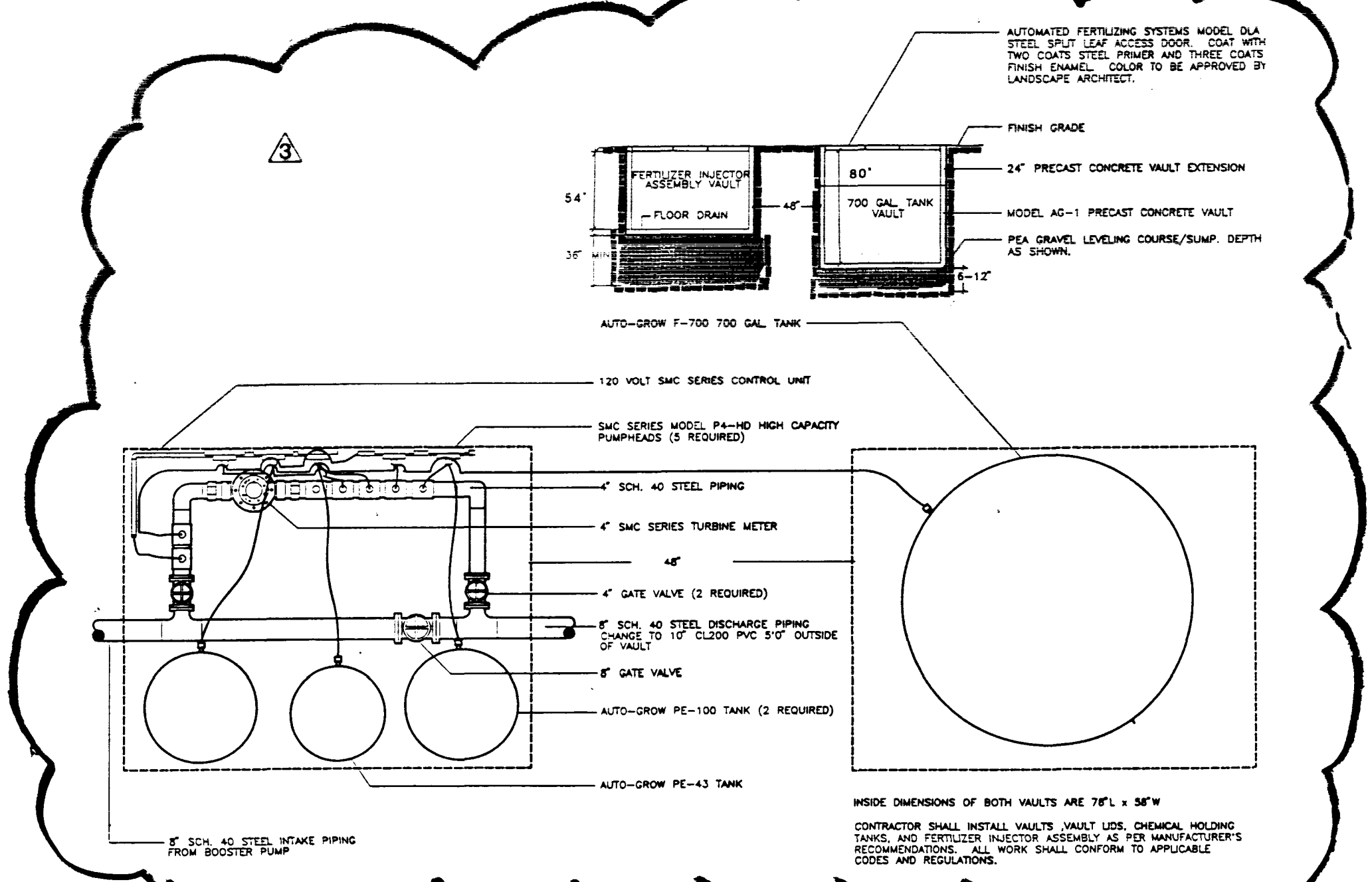

FERTILIZER INJECTION SYSTEM

13

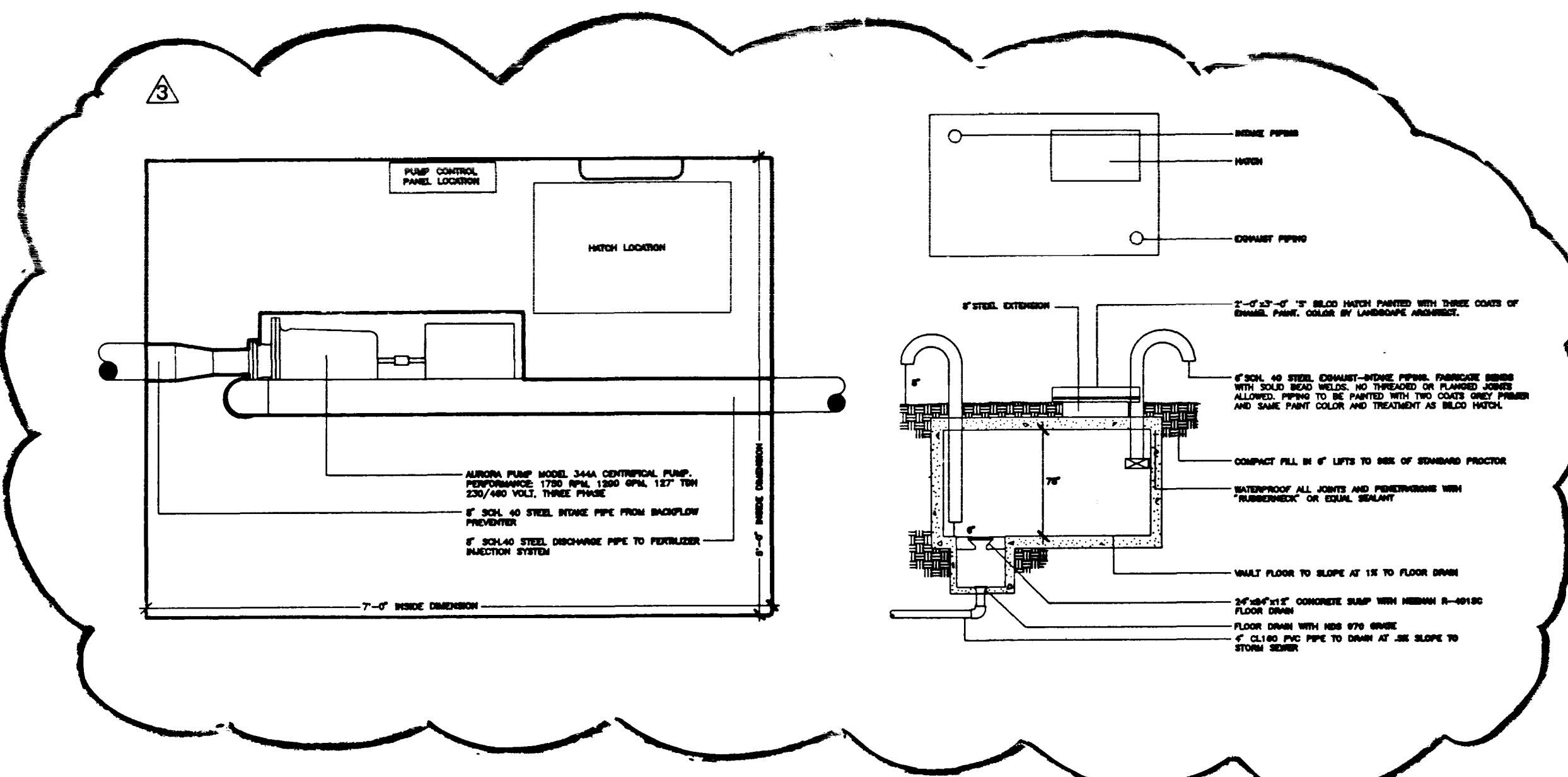

BOOSTER PUMP W/ VAULT

14

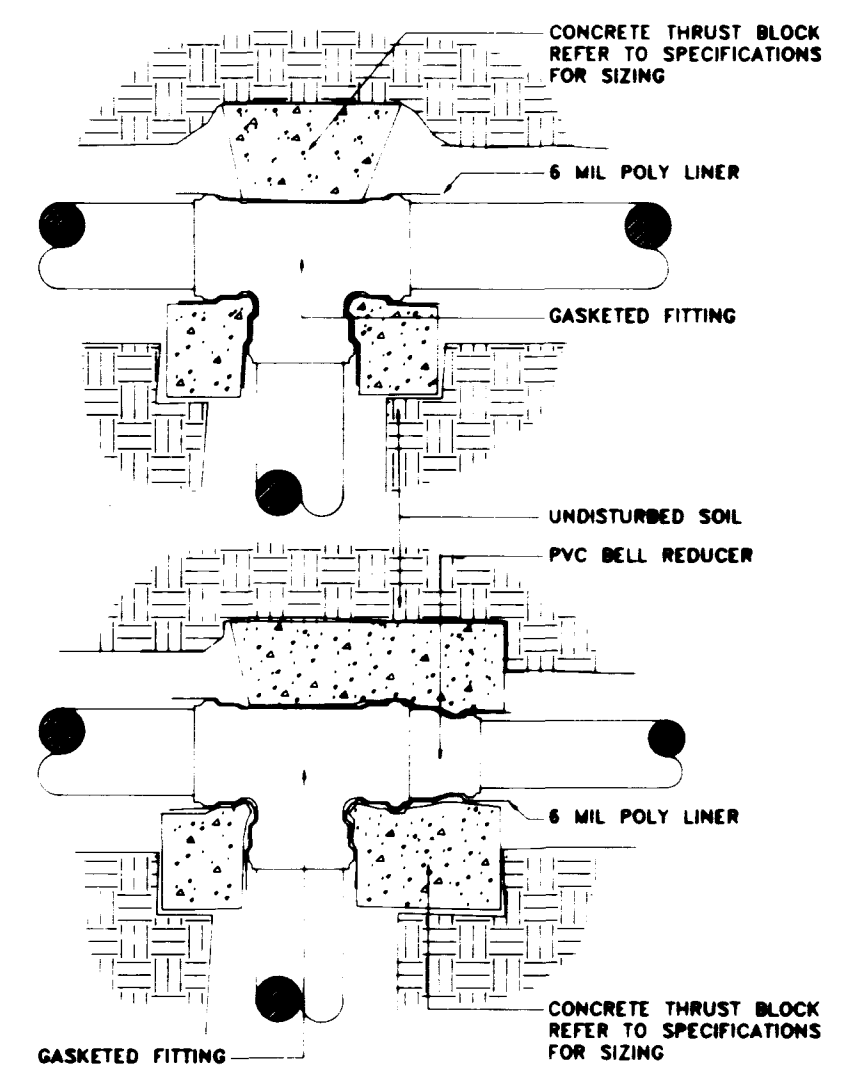

THRUST BLOCK DETAILS

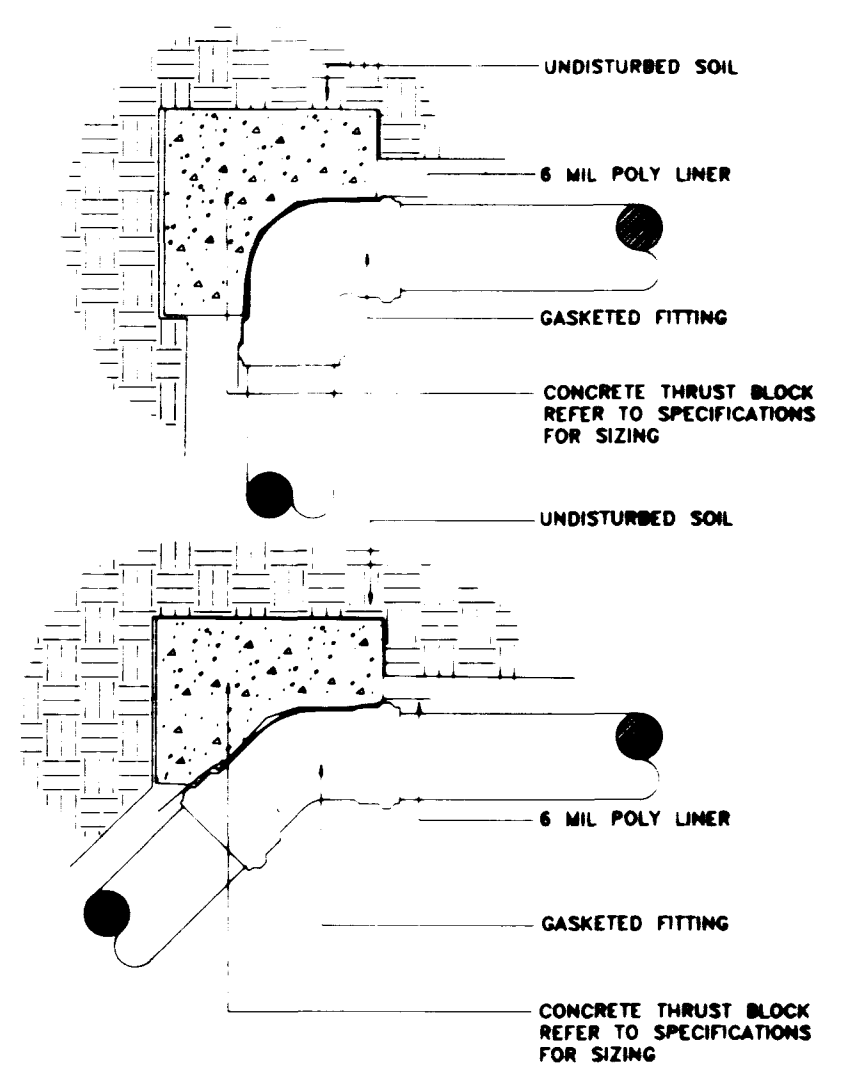

BUBBLER VALVE

15

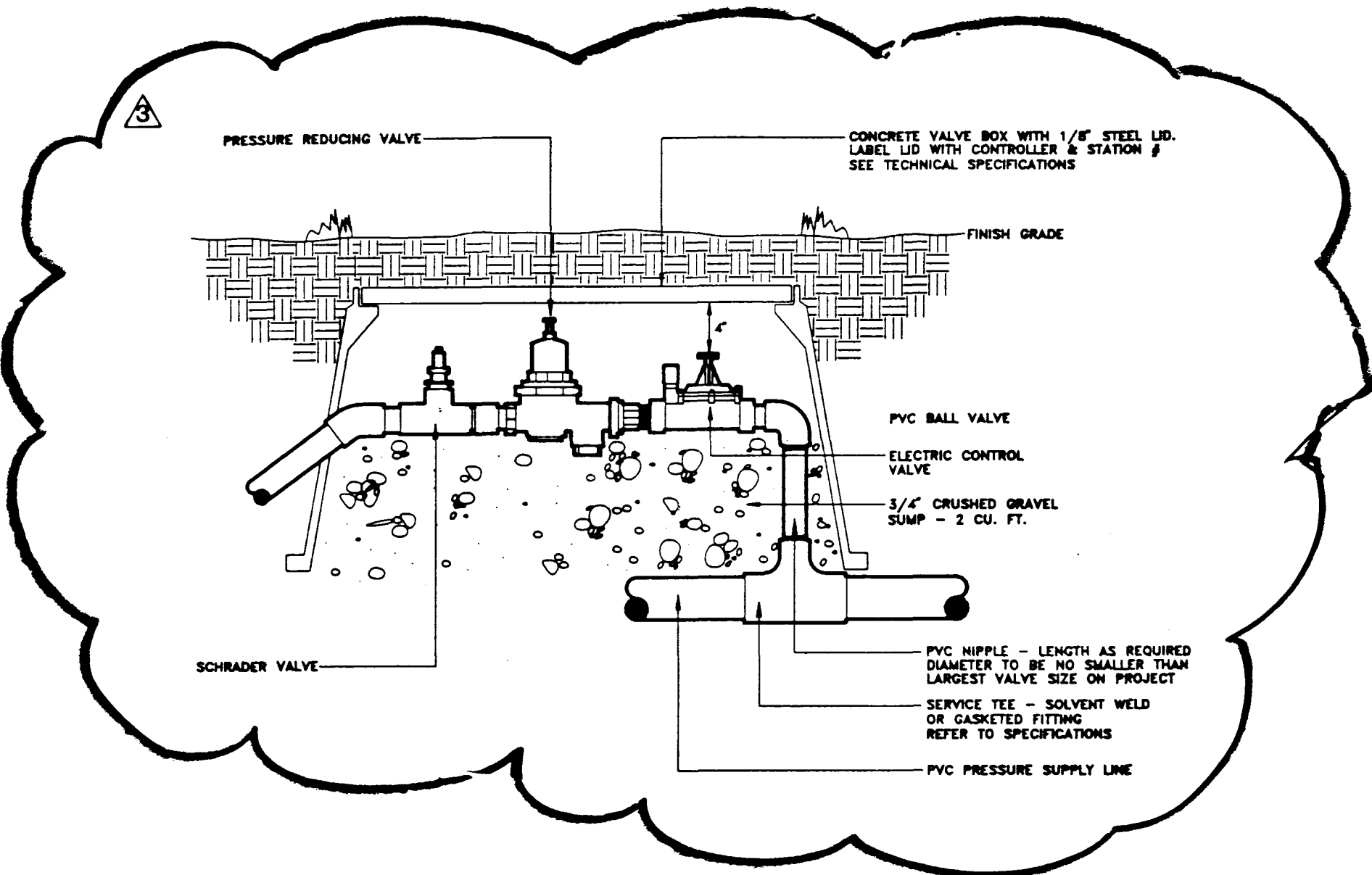

16

BUBBLER

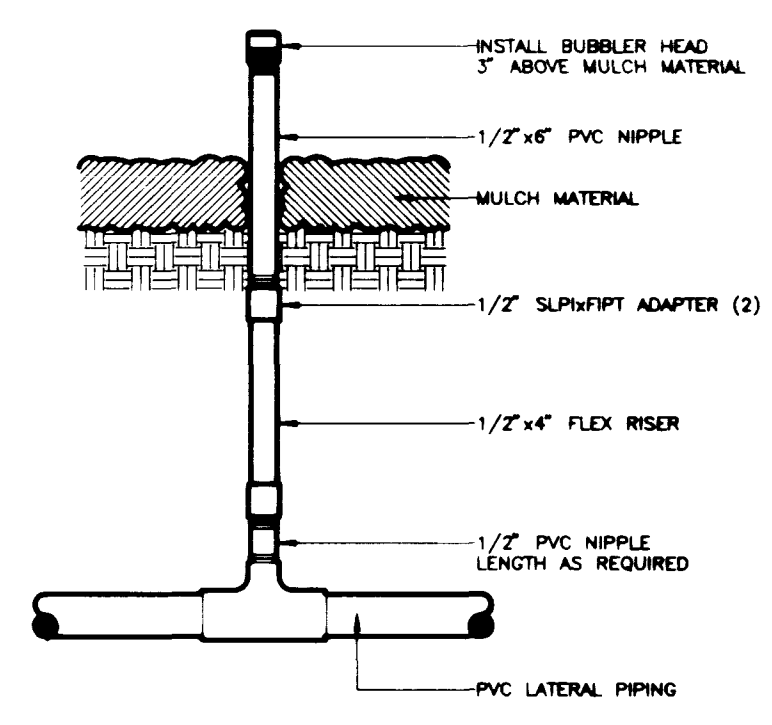

17

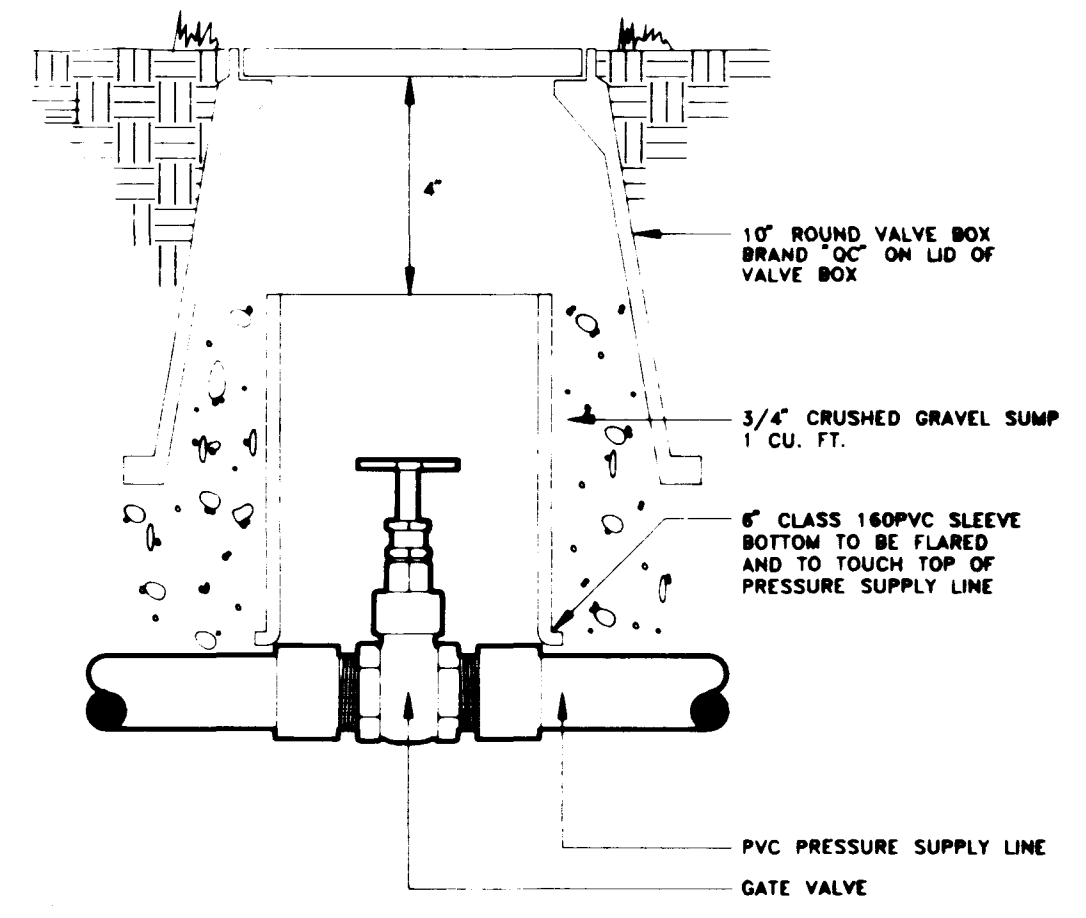

2 1/2" GATE VALVE

18

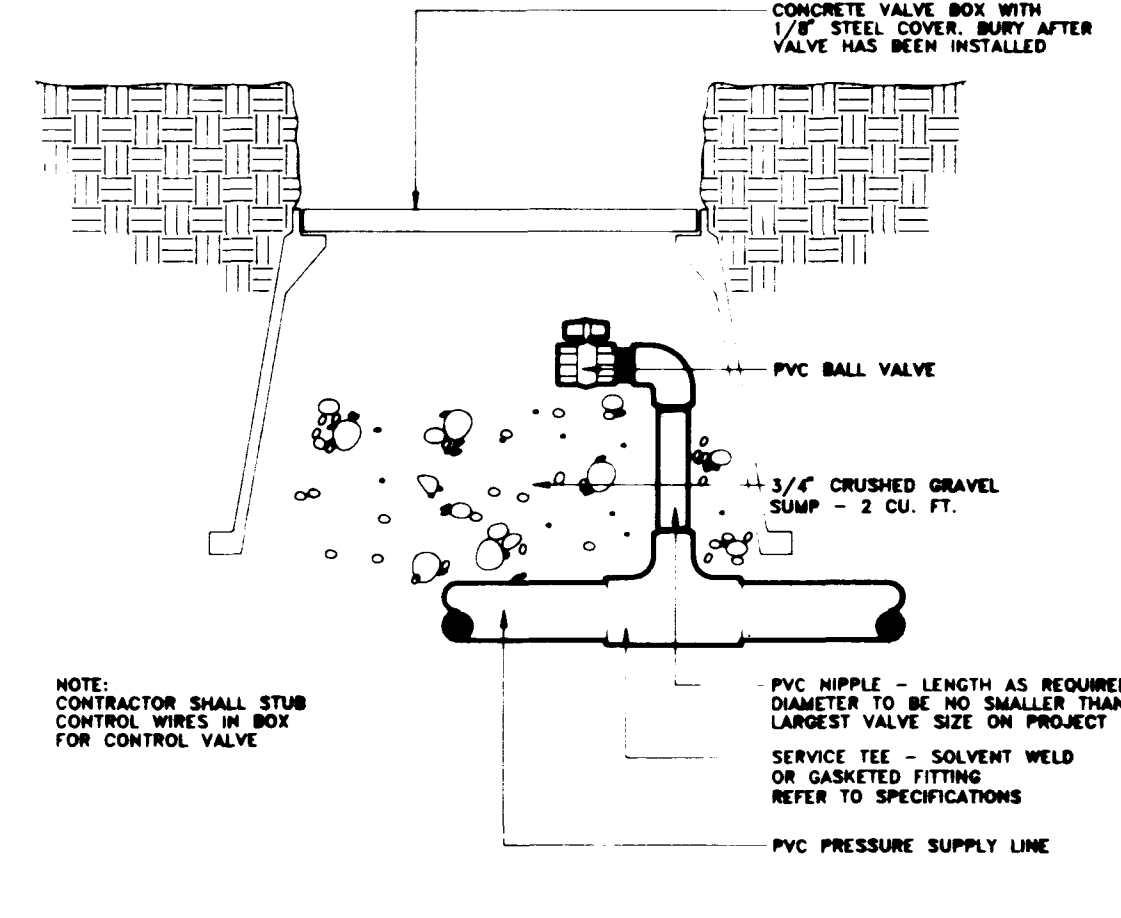

RISER ASSEMBLY

19

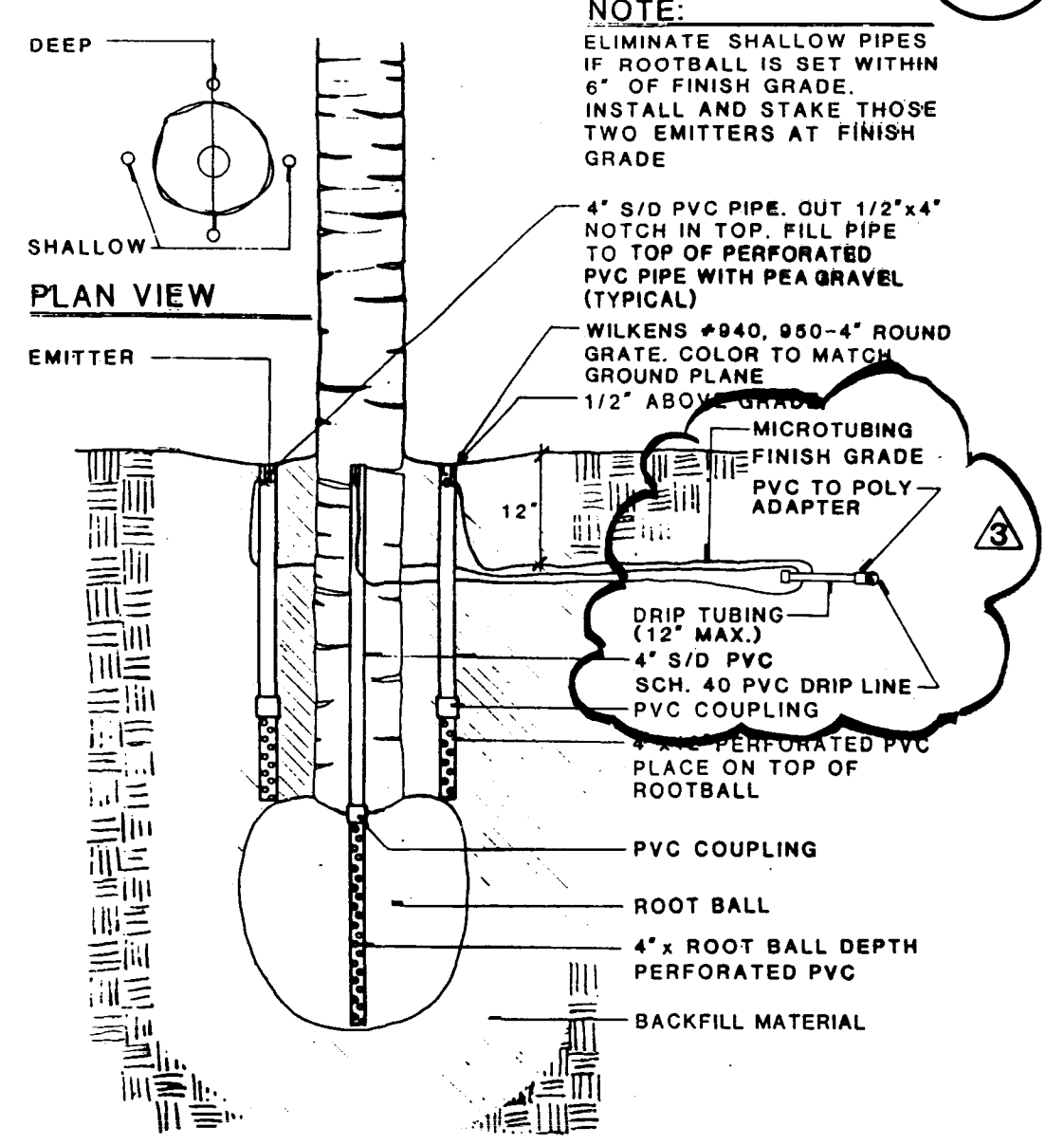

DRIP EMITTER-TREE

20

Bid No. 91-2610-10 Addendum # 3, FEB 11, 1991.

IRRIGATION DETAILS

ANGEL PARK NORTH LAS VEGAS, NEVADA

WO NO.	
BY	SEM
DATE	9/21/90
SCALE	

SHEET	38
OF	76 SHEETS
650.14-V14	

CONSULTING ENGINEERS - PLANNERS  
 2300 PASEO DEL PRADO, BUILDING A, SUITE 100  
 LAS VEGAS, NEVADA 89102 PHONE (702) 873-7550

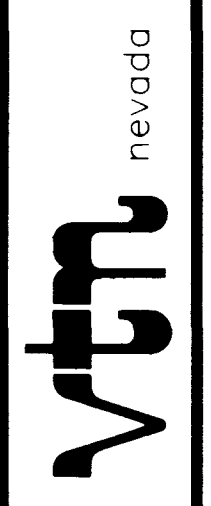



MANUAL DRAIN VALVE

12

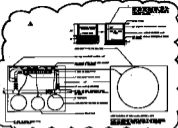

FERTILIZER INJECTION SYSTEM

13

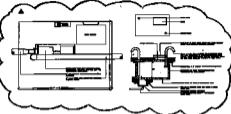

BOOSTER PUMP W/ VAULT

14



THRUST BLOCK DETAILS

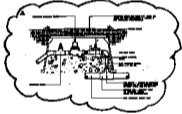

BUBBLER VALVE

15



BUBBLER

17

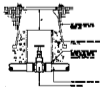

2 1/2" GATE VALVE

18



RISER ASSEMBLY

19



DRIP EMITTER-TREE

20

VTI  
 VENTURA TIRE & RUBBER, INC.  
 1000 S. GARDEN ST., SUITE 100  
 GARDEN CITY, CALIF. 92345  
 (714) 261-1111  
 FAX (714) 261-1112  
 WWW.VTI-USA.COM

IRRIGATION DETAILS  
 ANGEL PARK NORTH  
 LAS VEGAS, NEVADA

15