

DETAIL 1
SCALE: 3" = 1'-0"

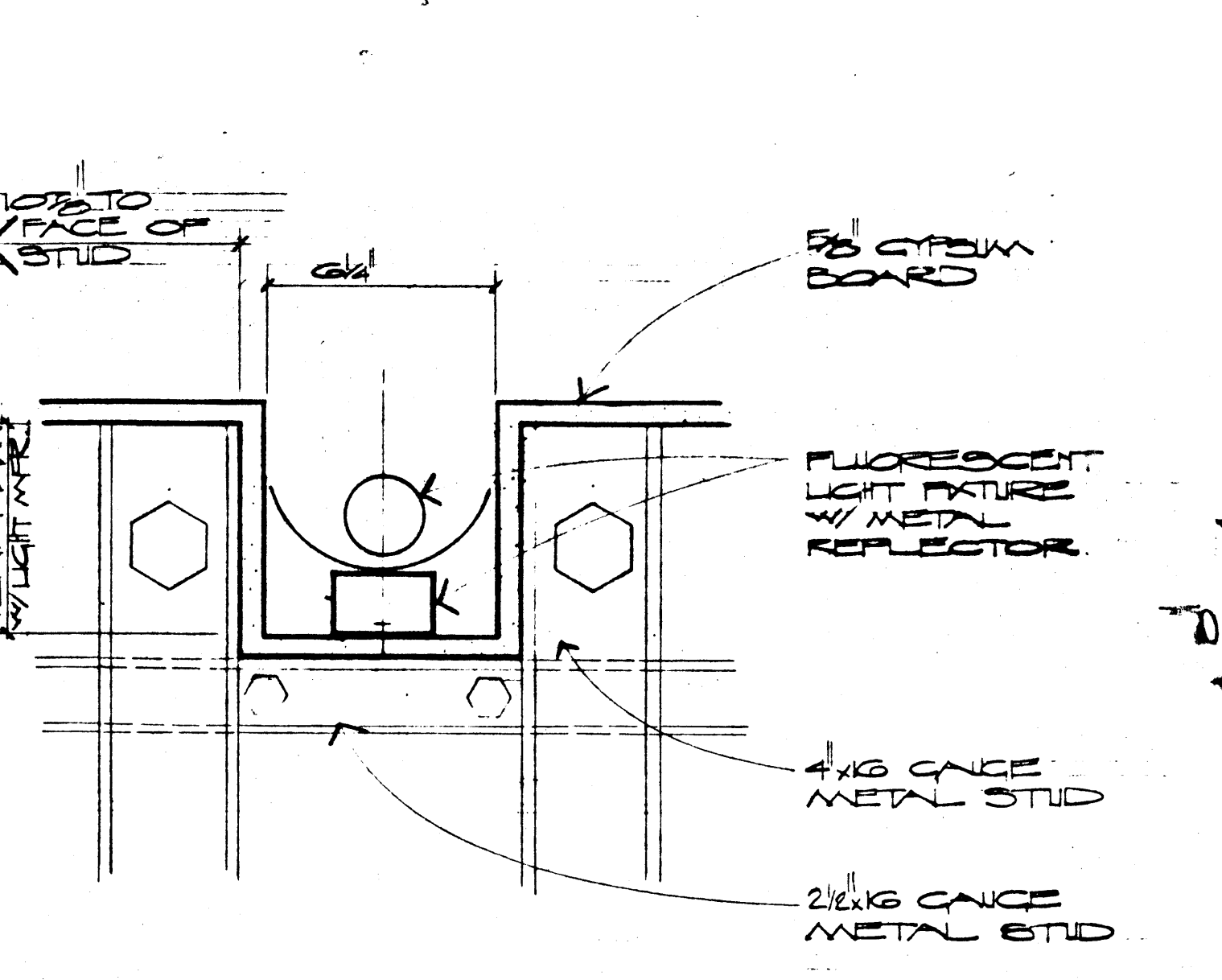

DETAIL 2
SCALE: 3" = 1'-0"

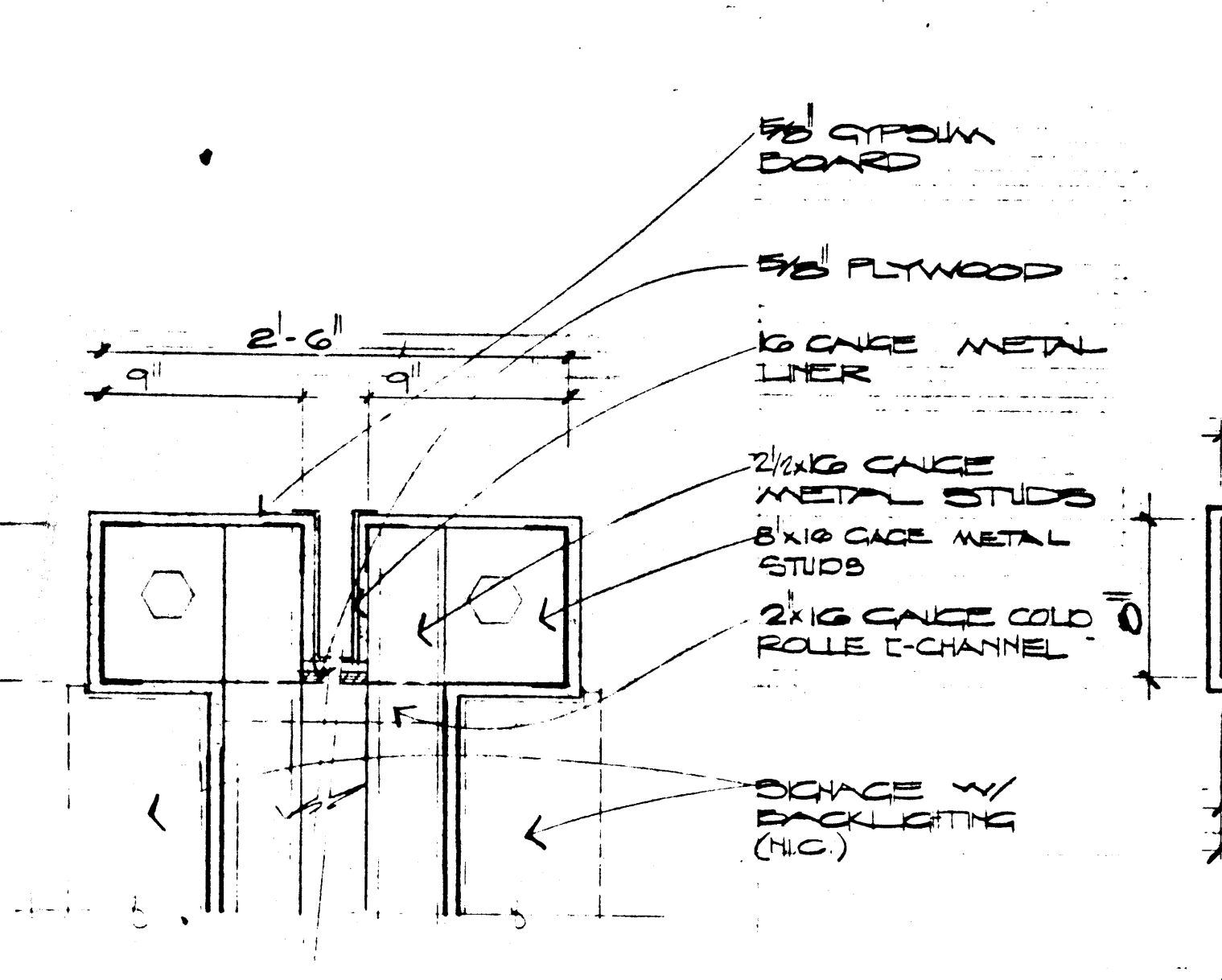

DETAIL 3
SCALE: 1 1/2" = 1'-0"

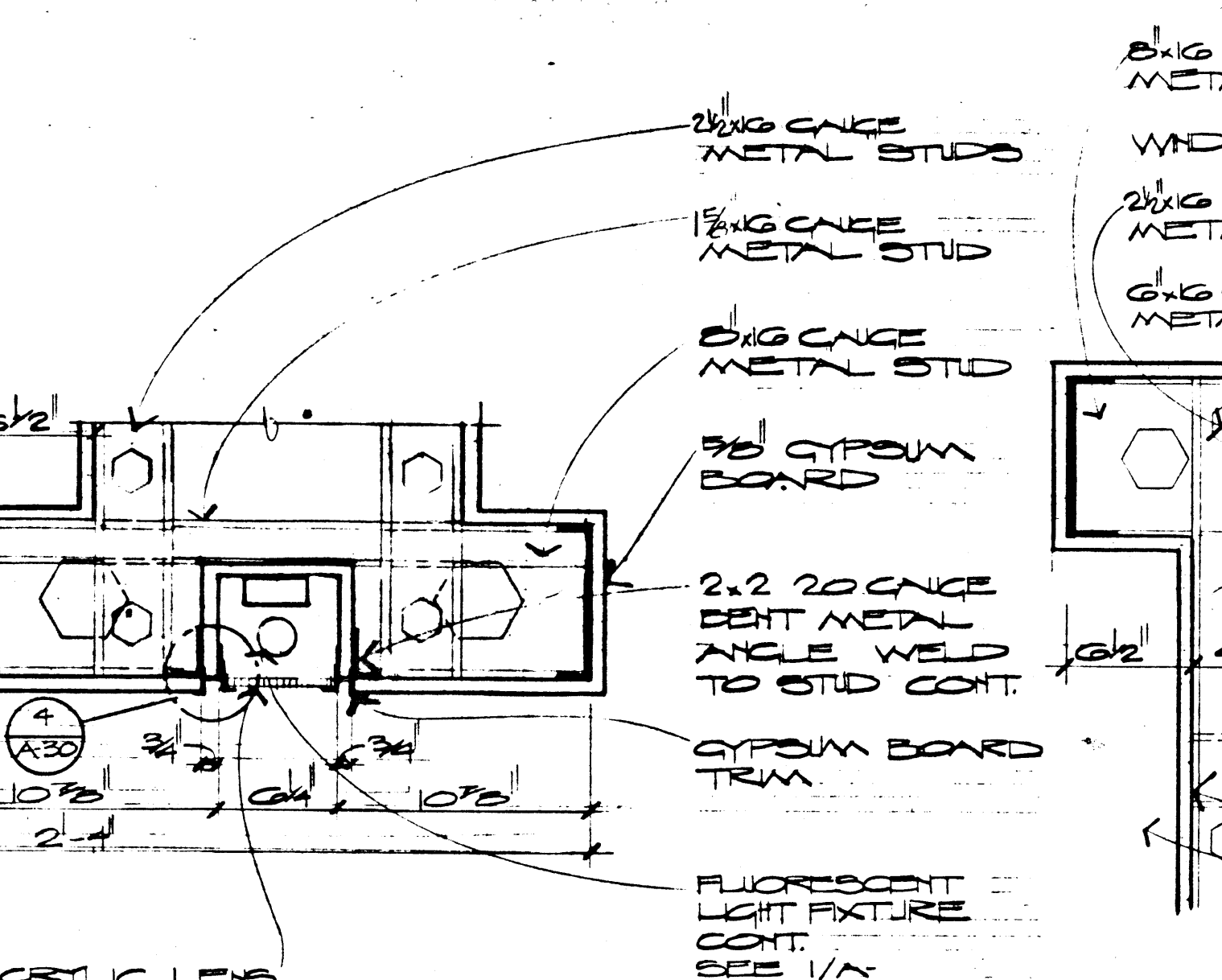

DETAIL 4
SCALE: 1 1/2" = 1'-0"

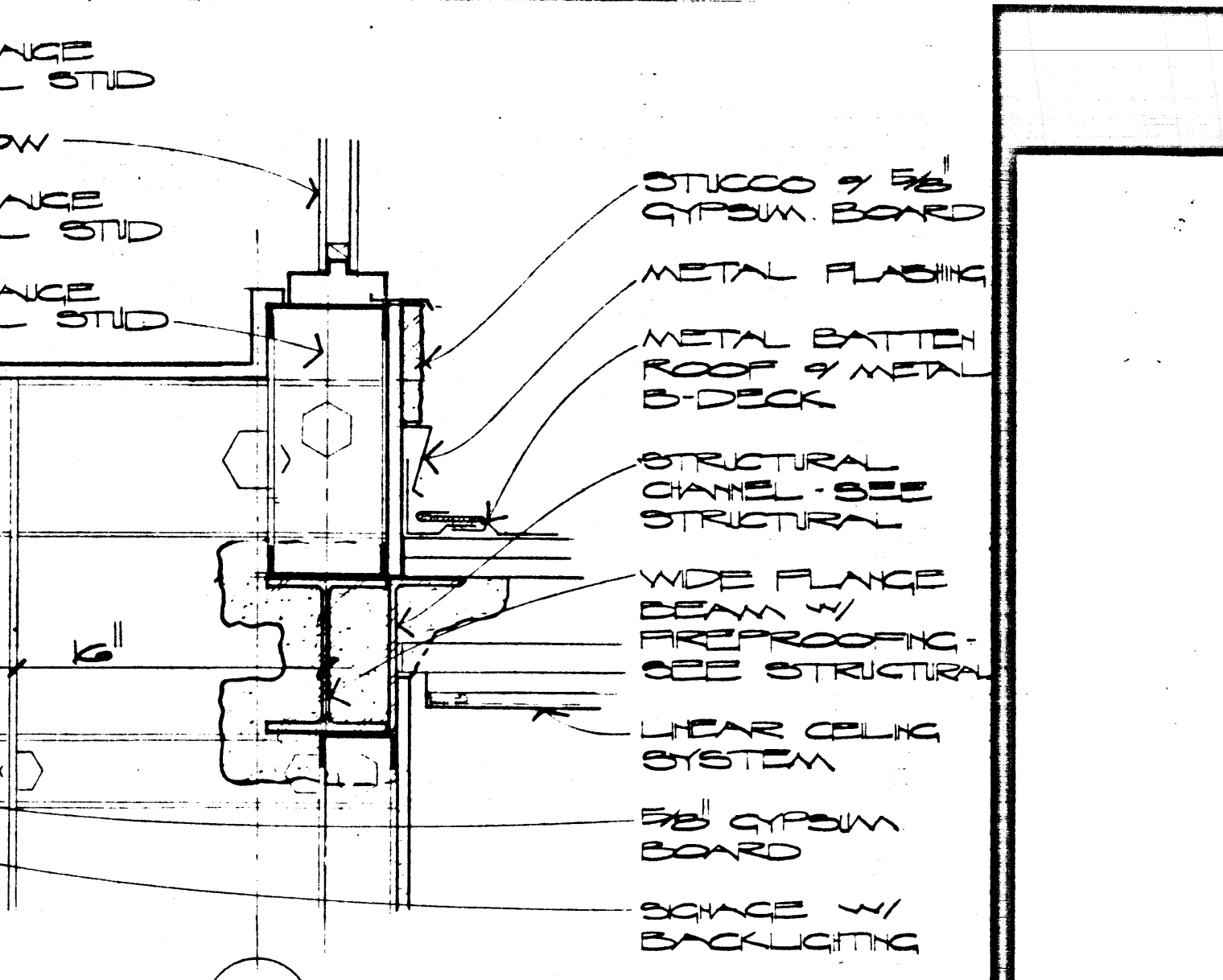

DETAIL 5
SCALE: 1 1/2" = 1'-0"

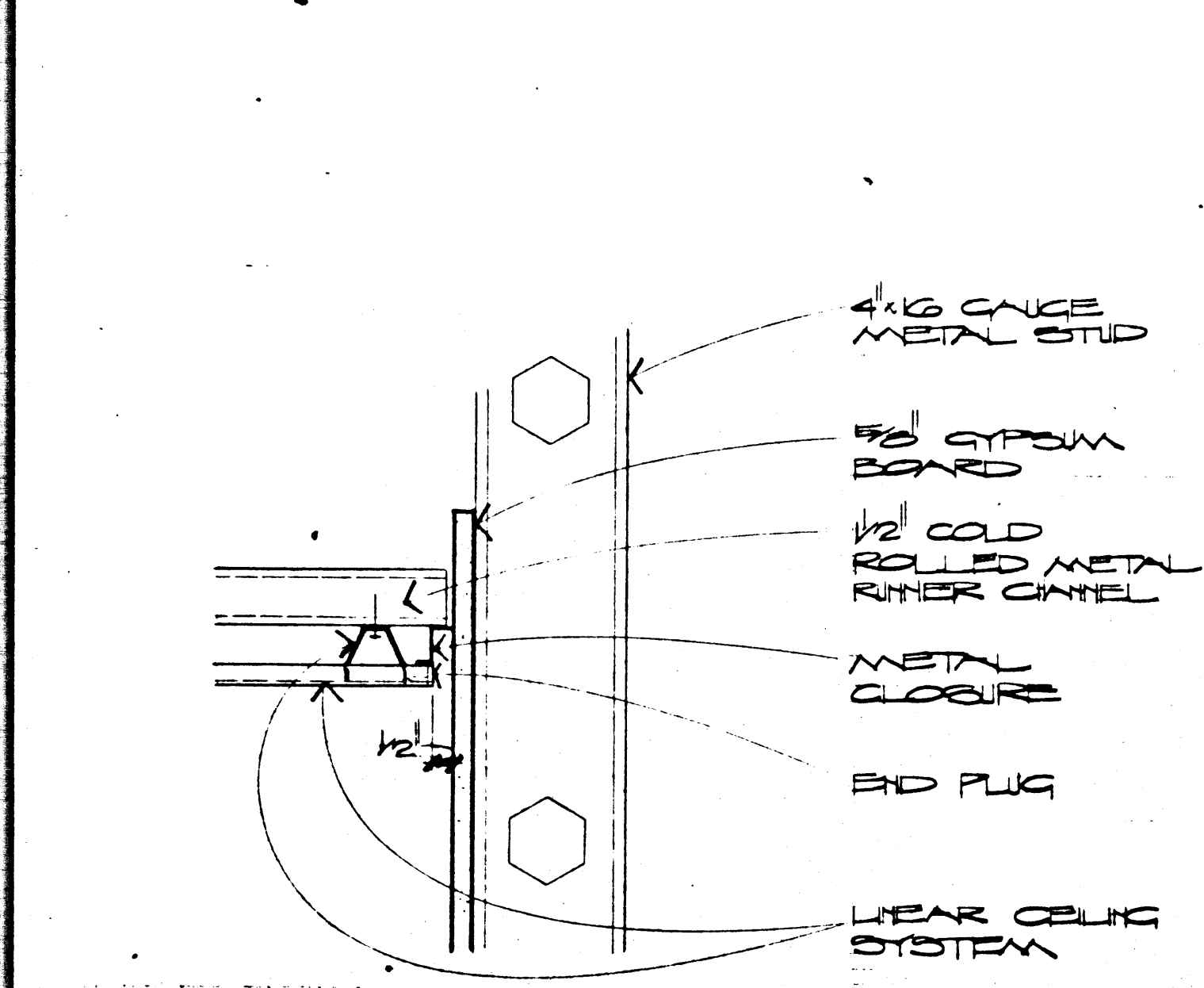

DETAIL 6
SCALE: 3" = 1'-0"

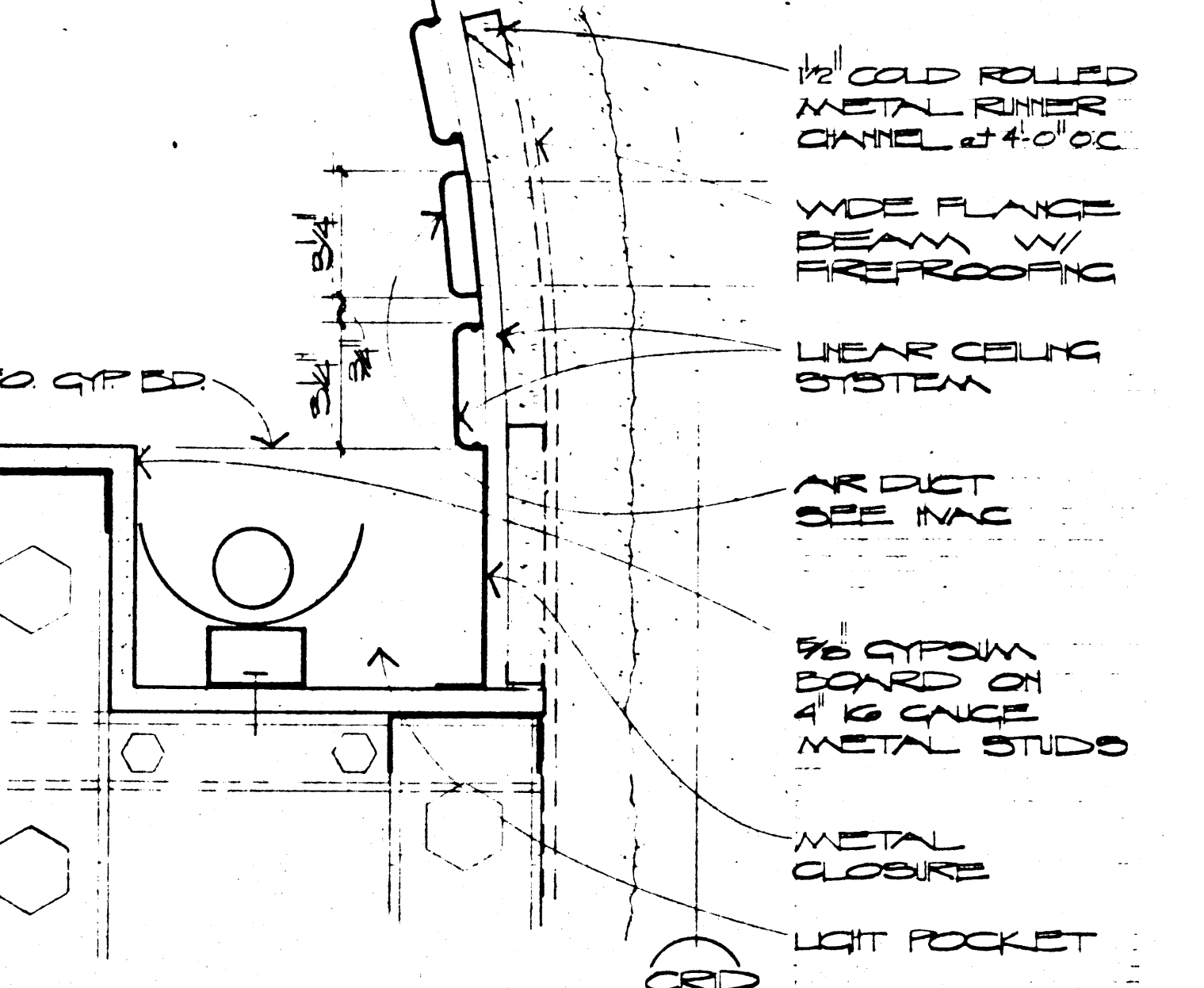

DETAIL 7
SCALE: 3" = 1'-0"

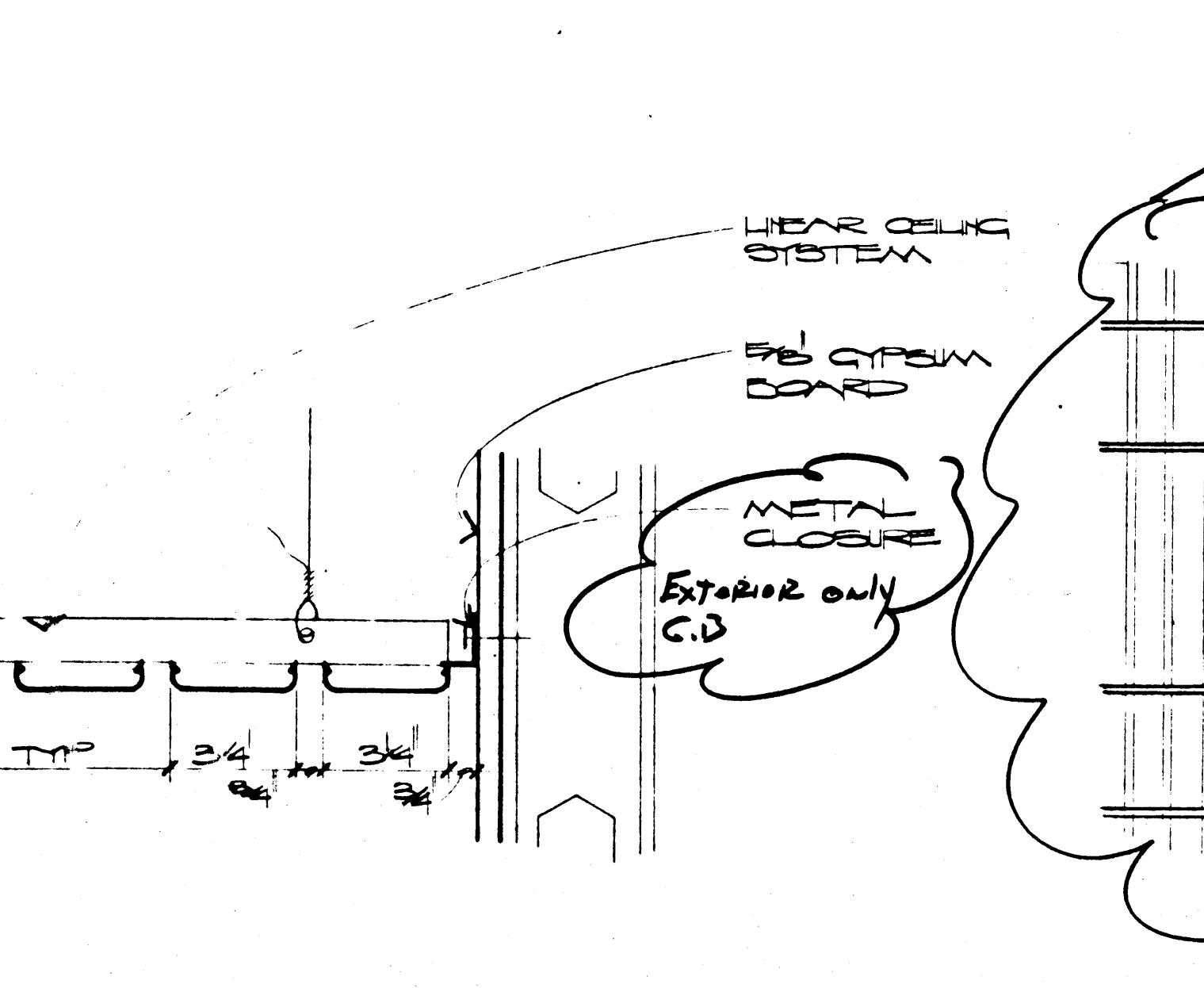

DETAIL 8
SCALE: 3" = 1'-0"

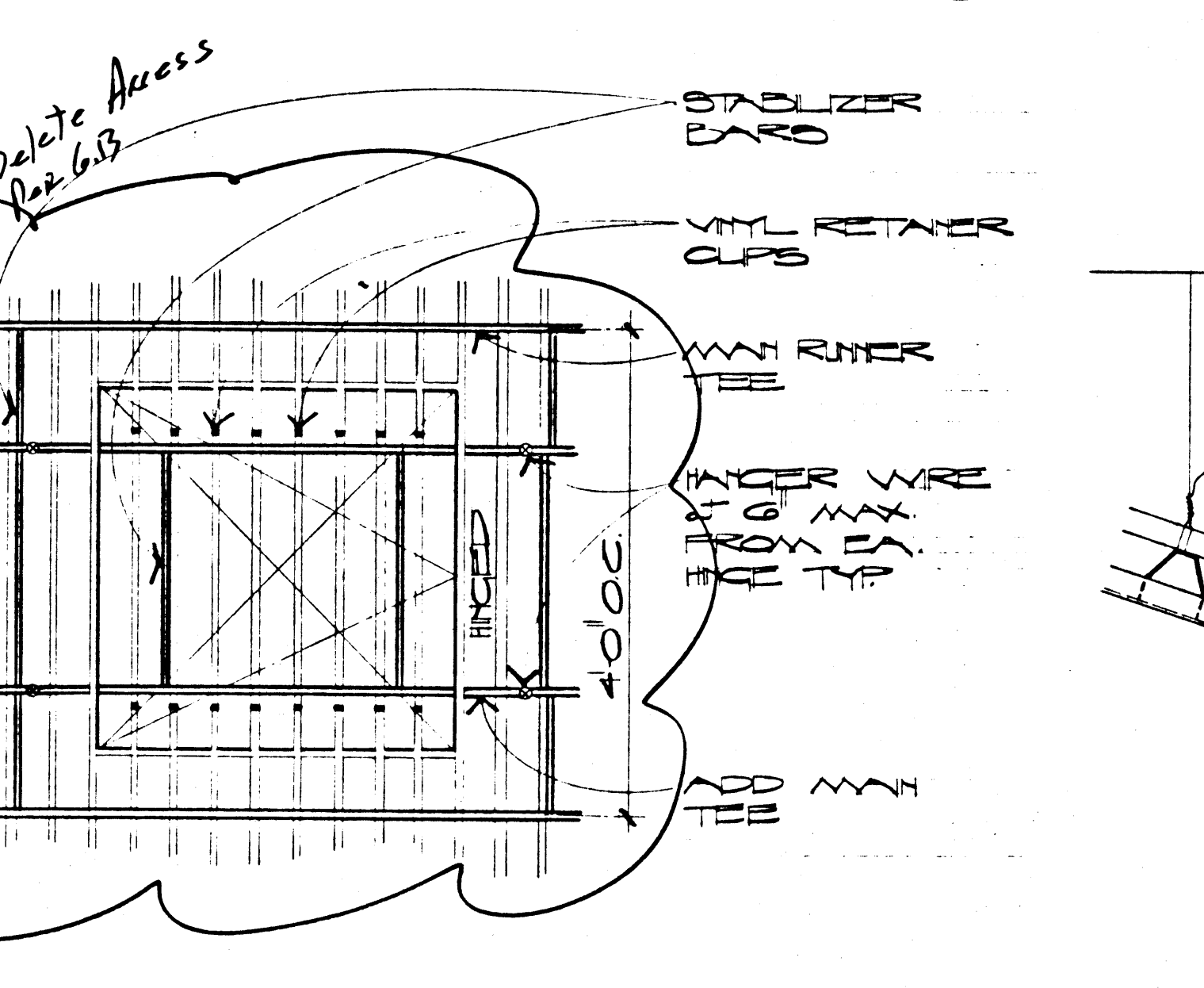

DETAIL 9
SCALE: 3/4" = 1'-0"

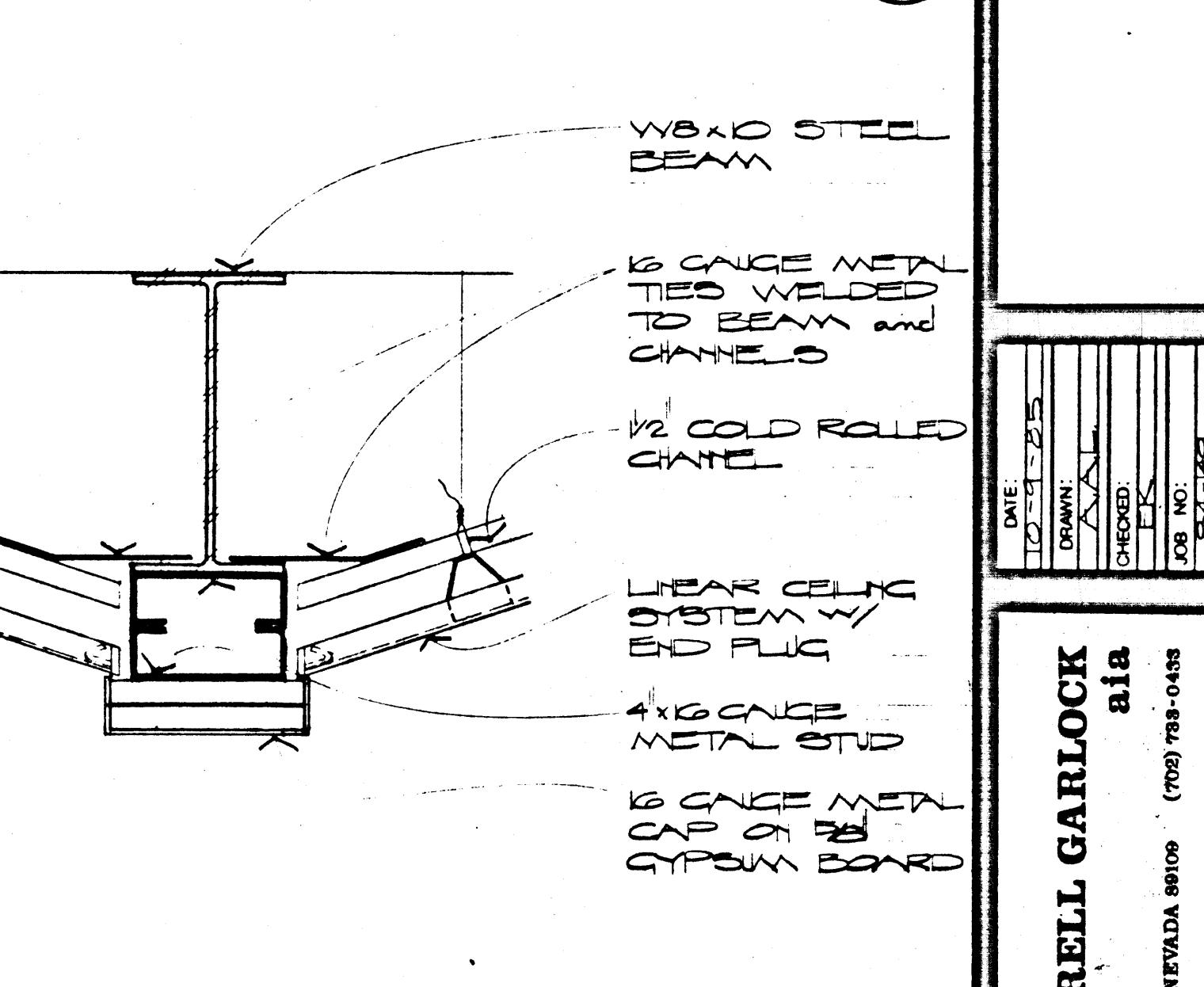

DETAIL 10
SCALE: 1 1/2" = 1'-0"

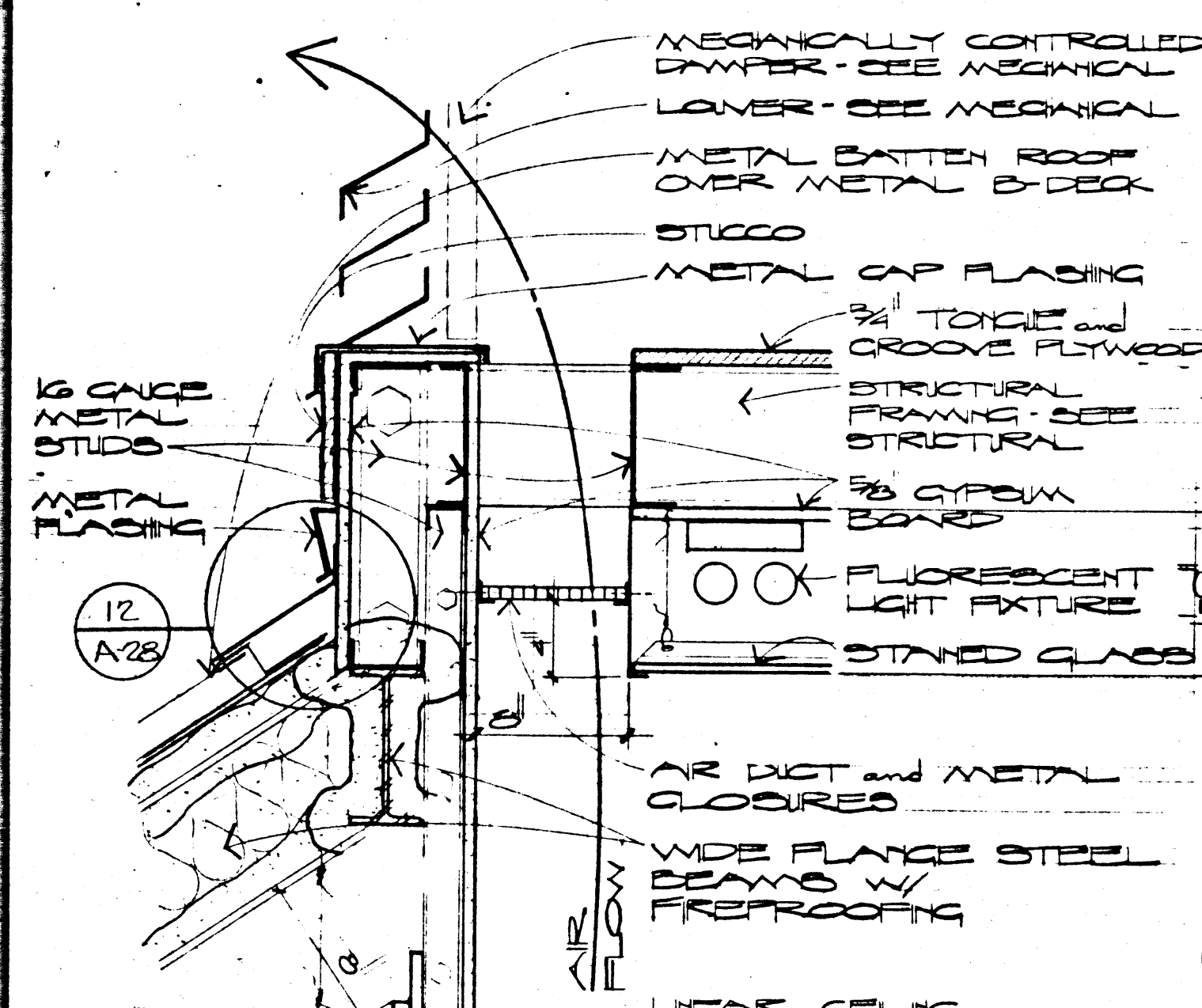

DETAIL 11
SCALE: 1 1/2" = 1'-0"

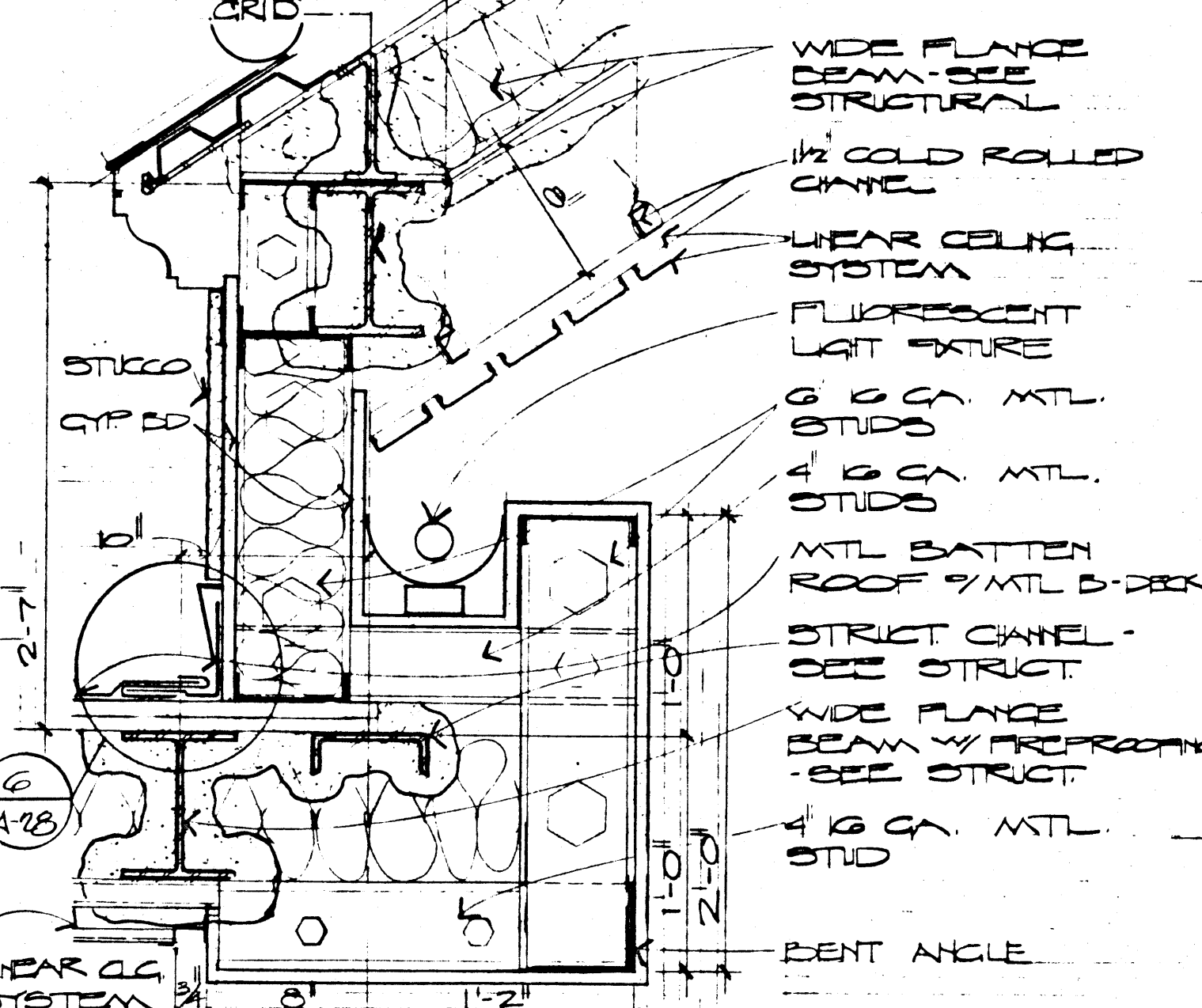

DETAIL 12
SCALE: 1 1/2" = 1'-0"

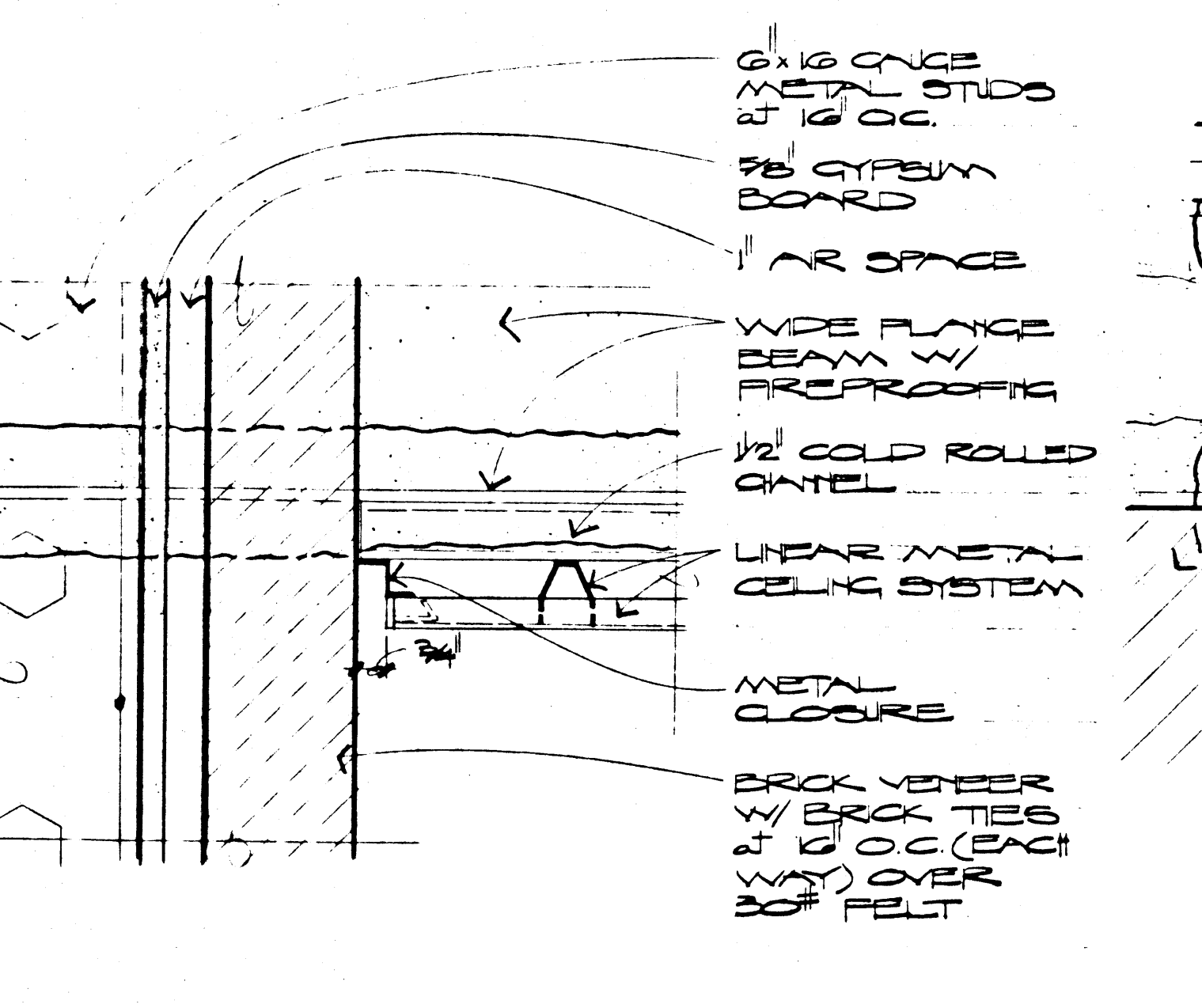

DETAIL 13
SCALE: 3" = 1'-0"

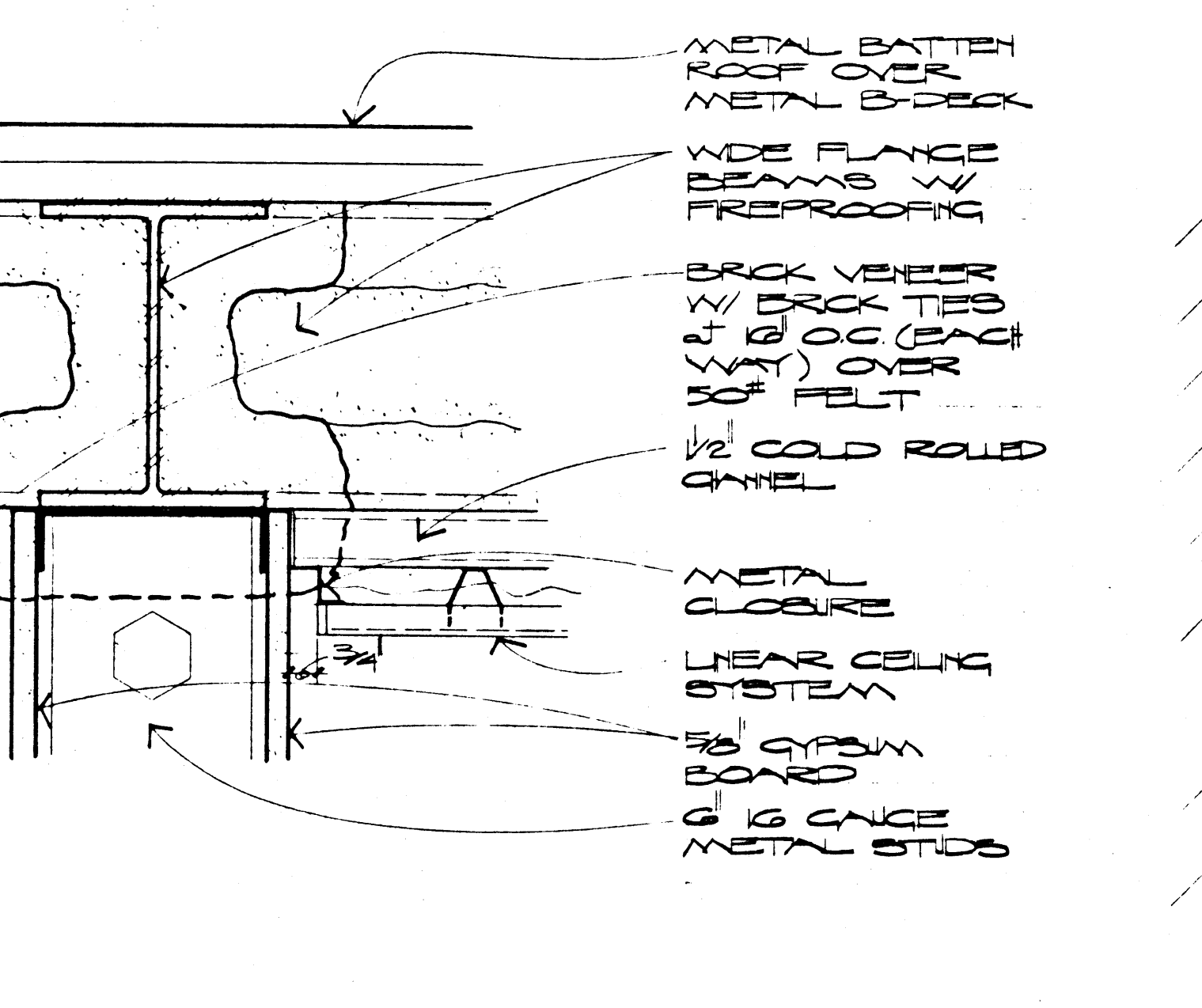

DETAIL 14
SCALE: 3" = 1'-0"

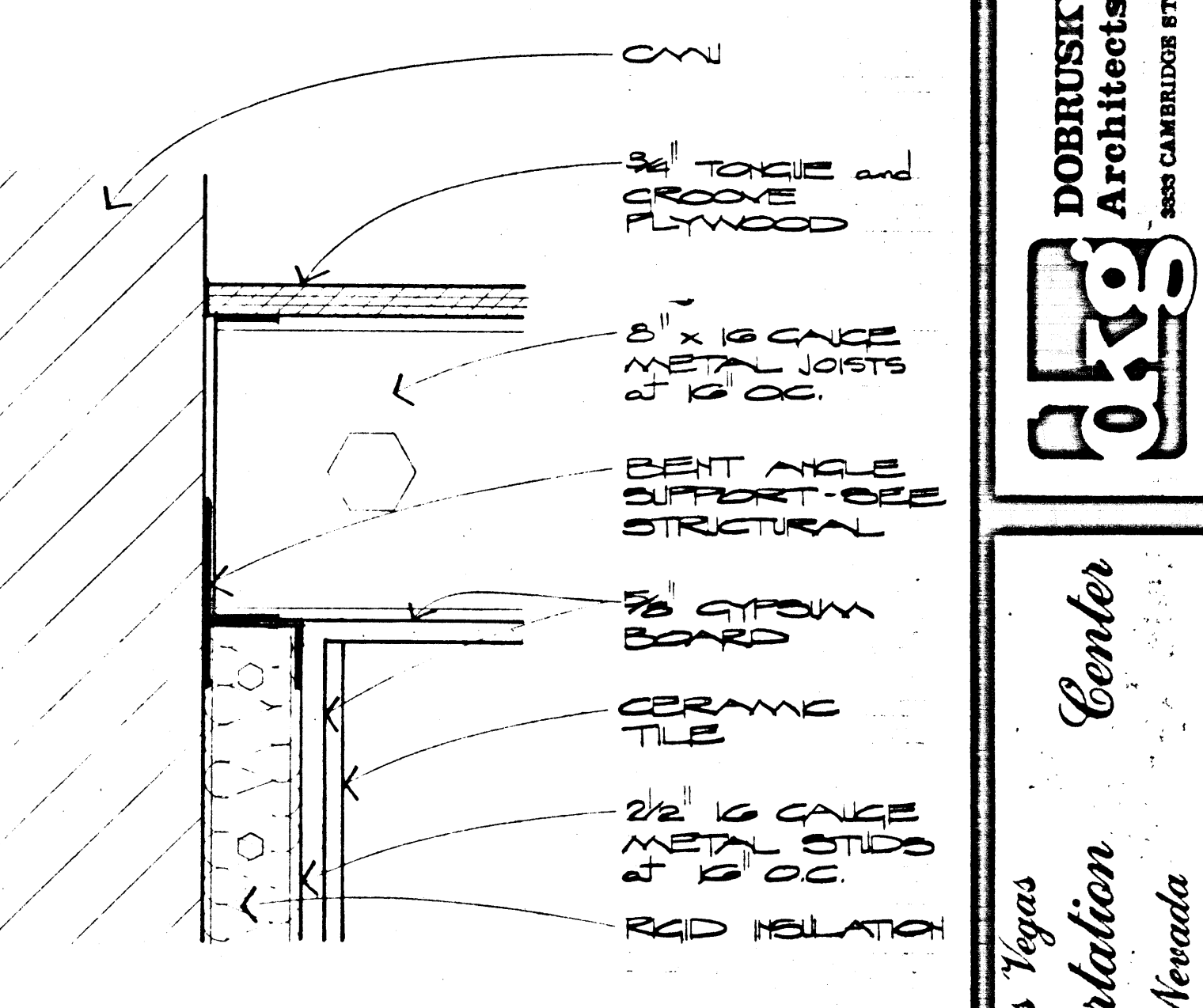

DETAIL 15
SCALE: 3" = 1'-0"

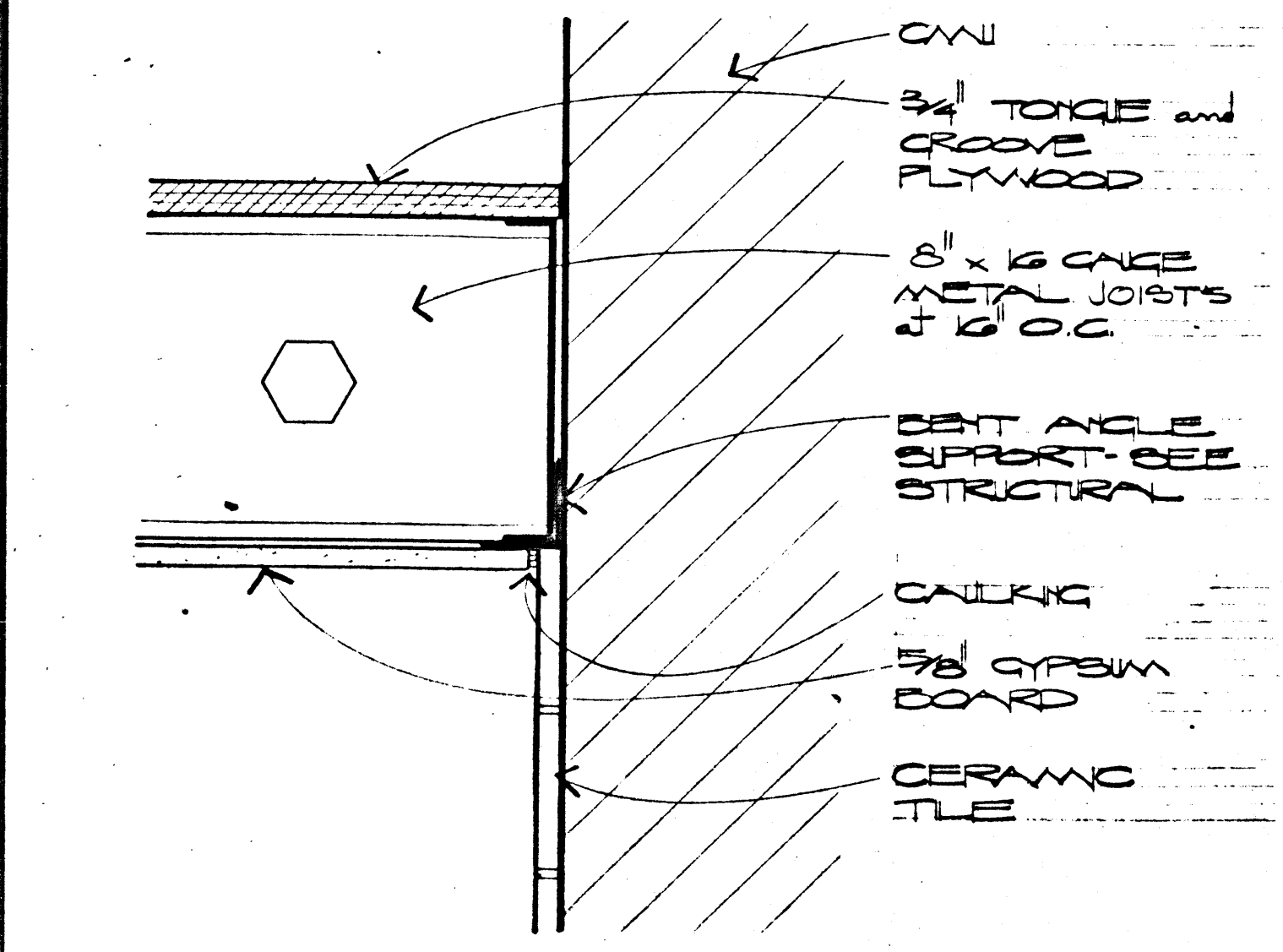

DETAIL 16
SCALE: 3" = 1'-0"

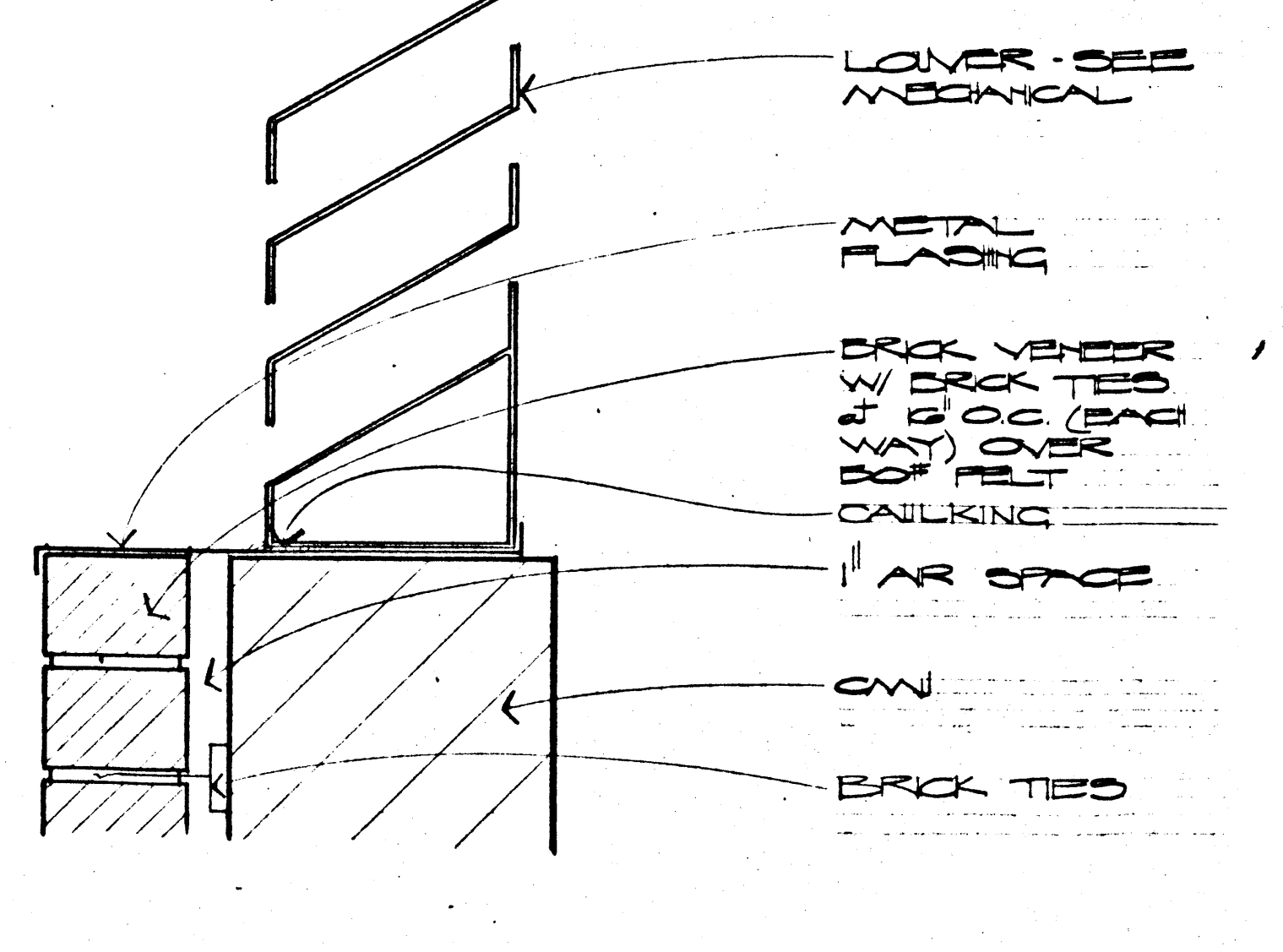

DETAIL 17
SCALE: 3" = 1'-0"

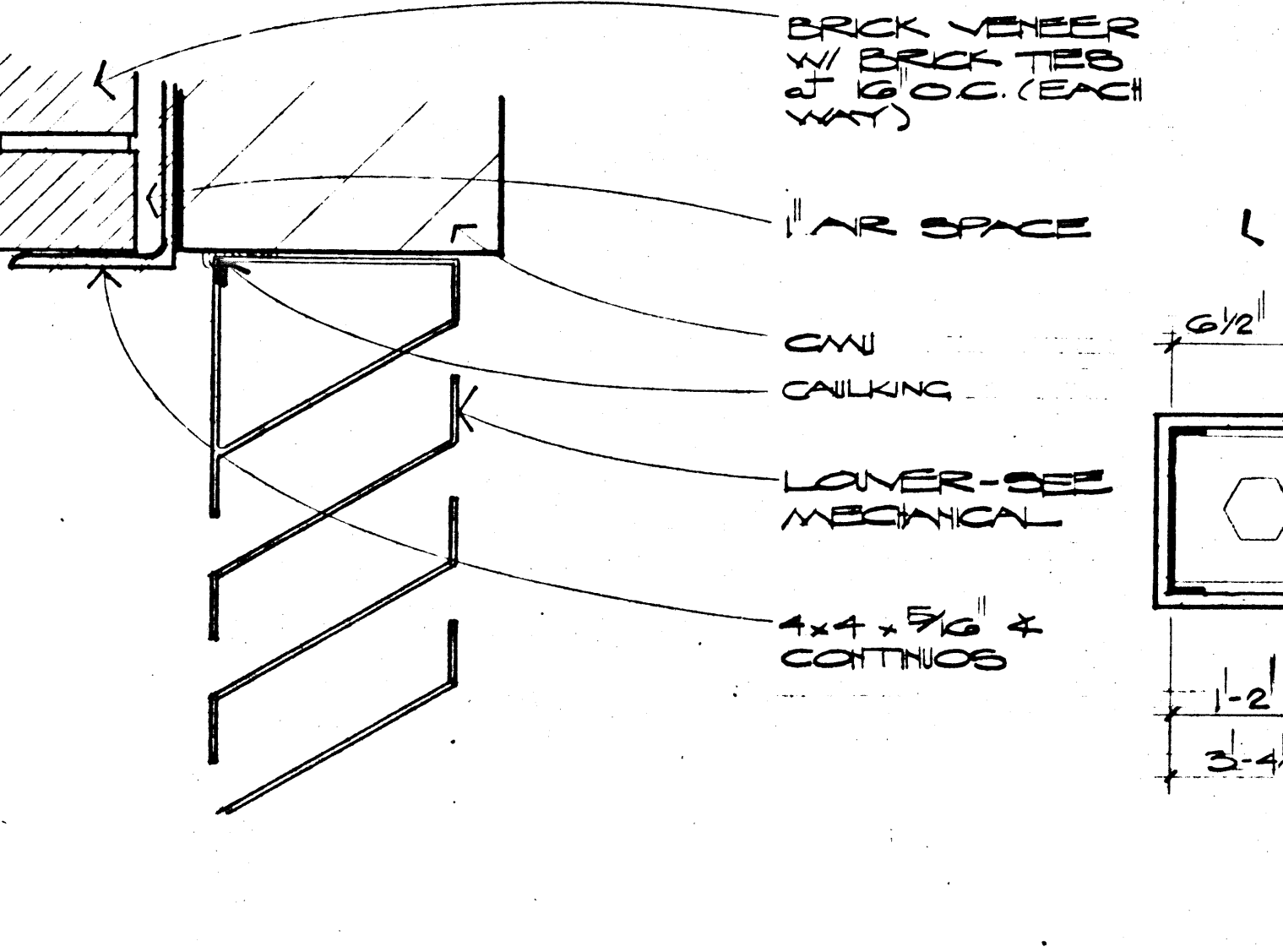

DETAIL 18
SCALE: 3" = 1'-0"

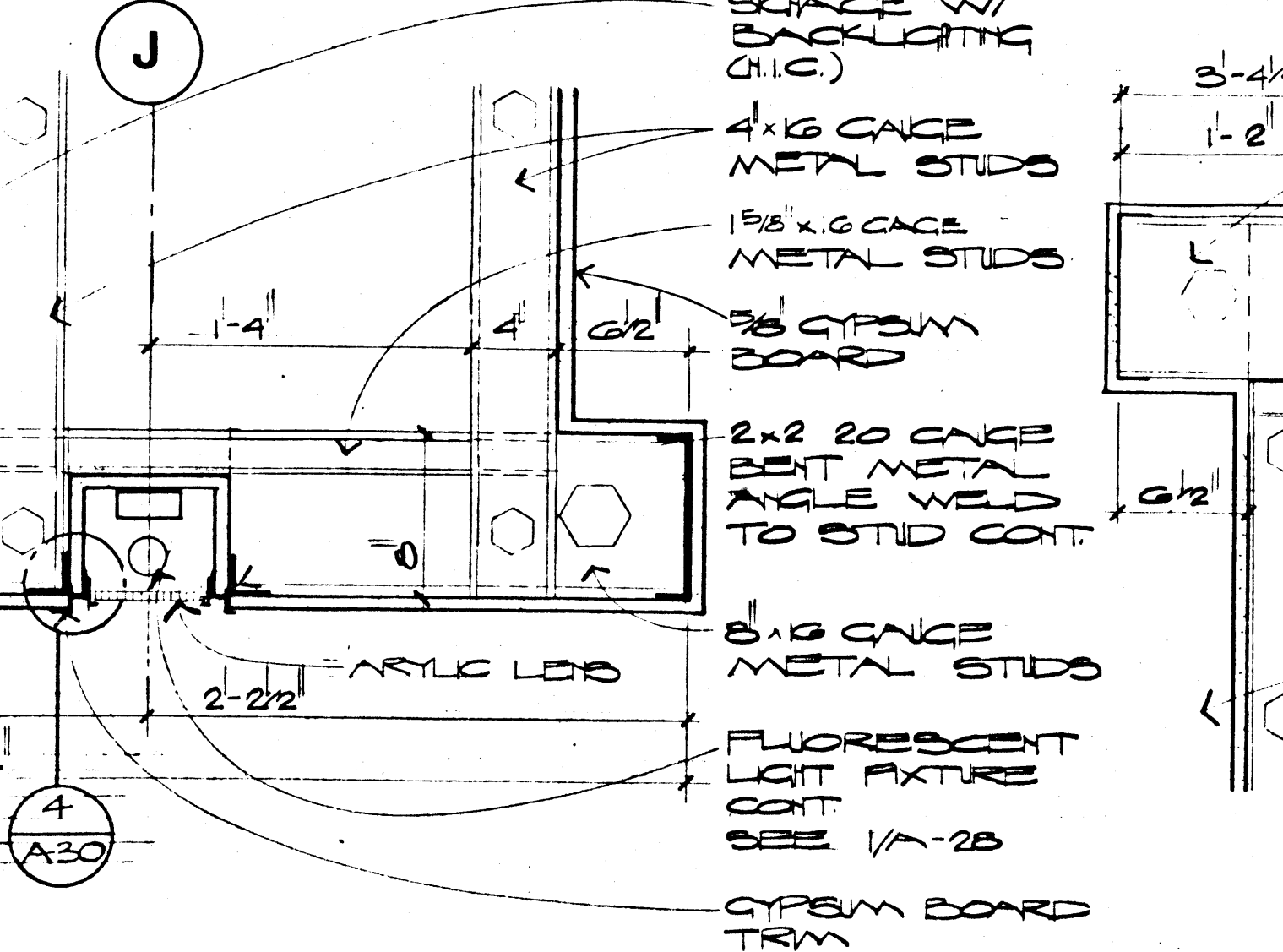

DETAIL 19
SCALE: 1 1/2" = 1'-0"

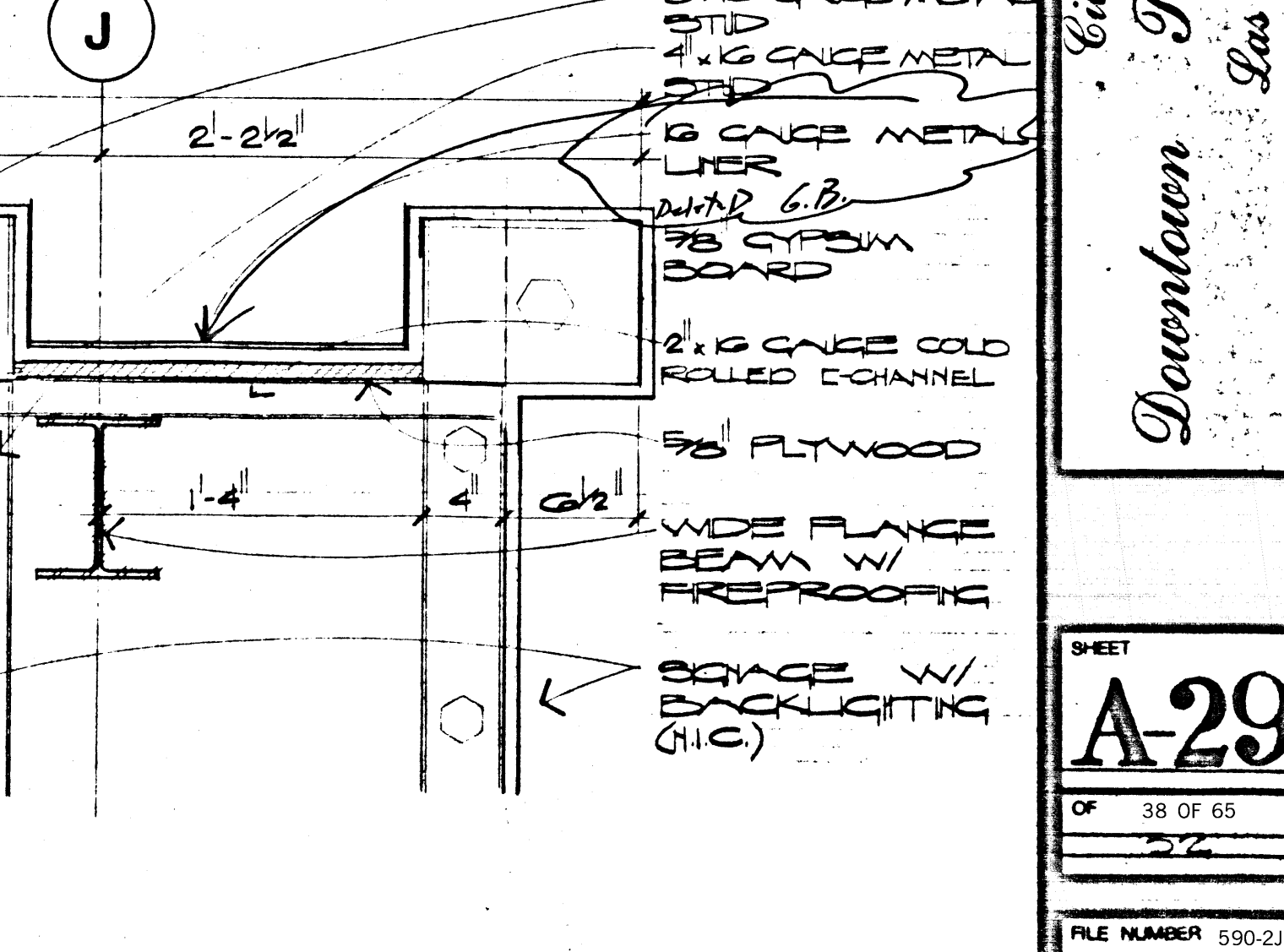

DETAIL 20
SCALE: 1 1/2" = 1'-0"

DATE: 11/15/11
DRAWN: JAL
CHECKED: JAL
SCALE: AS SHOWN
JOB NO.: 59021

DOBROUSKY KITTRELL GARLOCK & Associates
Architects
2005 CAMDEN RD. LAS VEGAS, NEVADA 89109 (702) 738-0458

Center for Transportation Downtown Las Vegas, Nevada

SHEET **A-29**
OF 38 OF 65
FILE NUMBER 59021