

HEAD
SCALE: 8" = 1'-0"
1
A-7

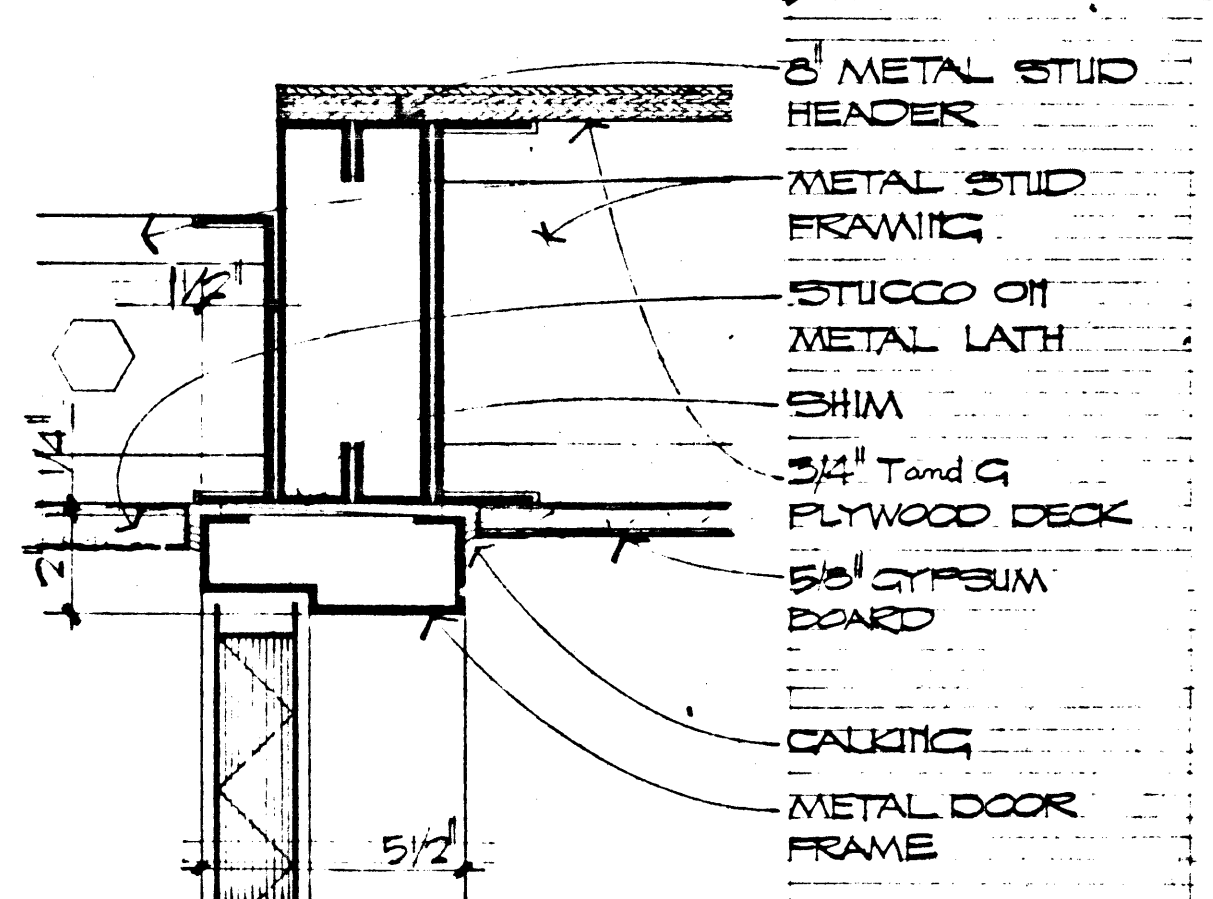

HEAD
SCALE: 8" = 1'-0"
2
A-7

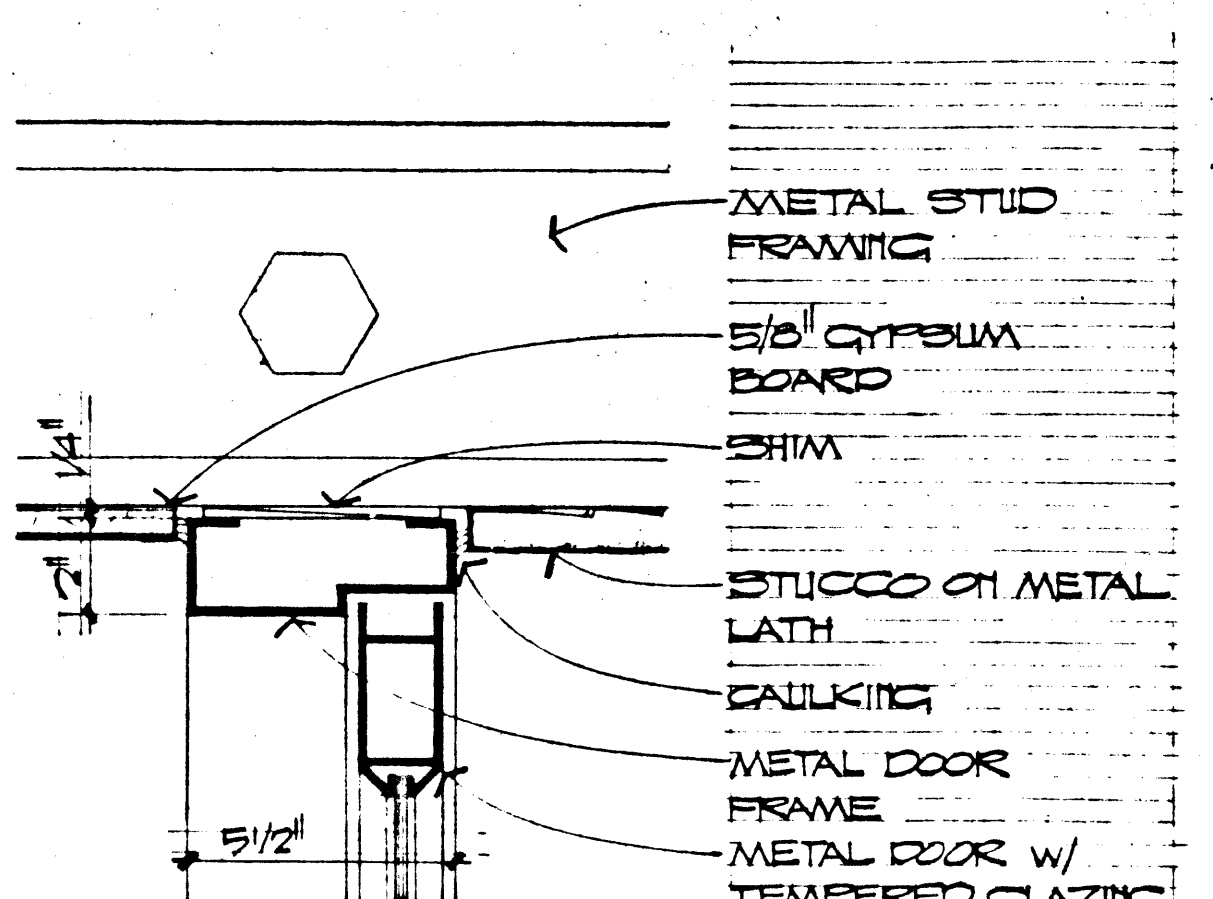

HEAD
SCALE: 8" = 1'-0"
3
A-7

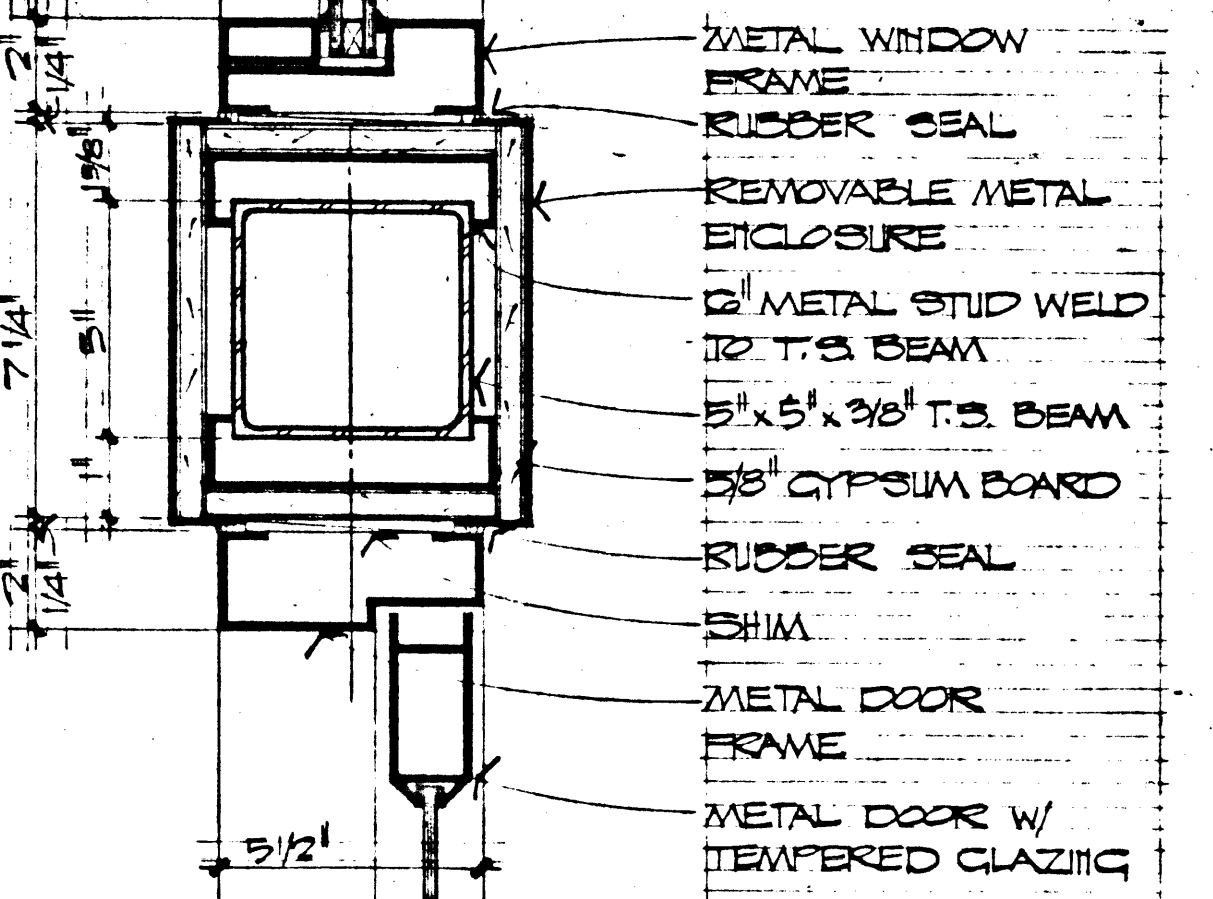

HEAD
SCALE: 8" = 1'-0"
4
A-7

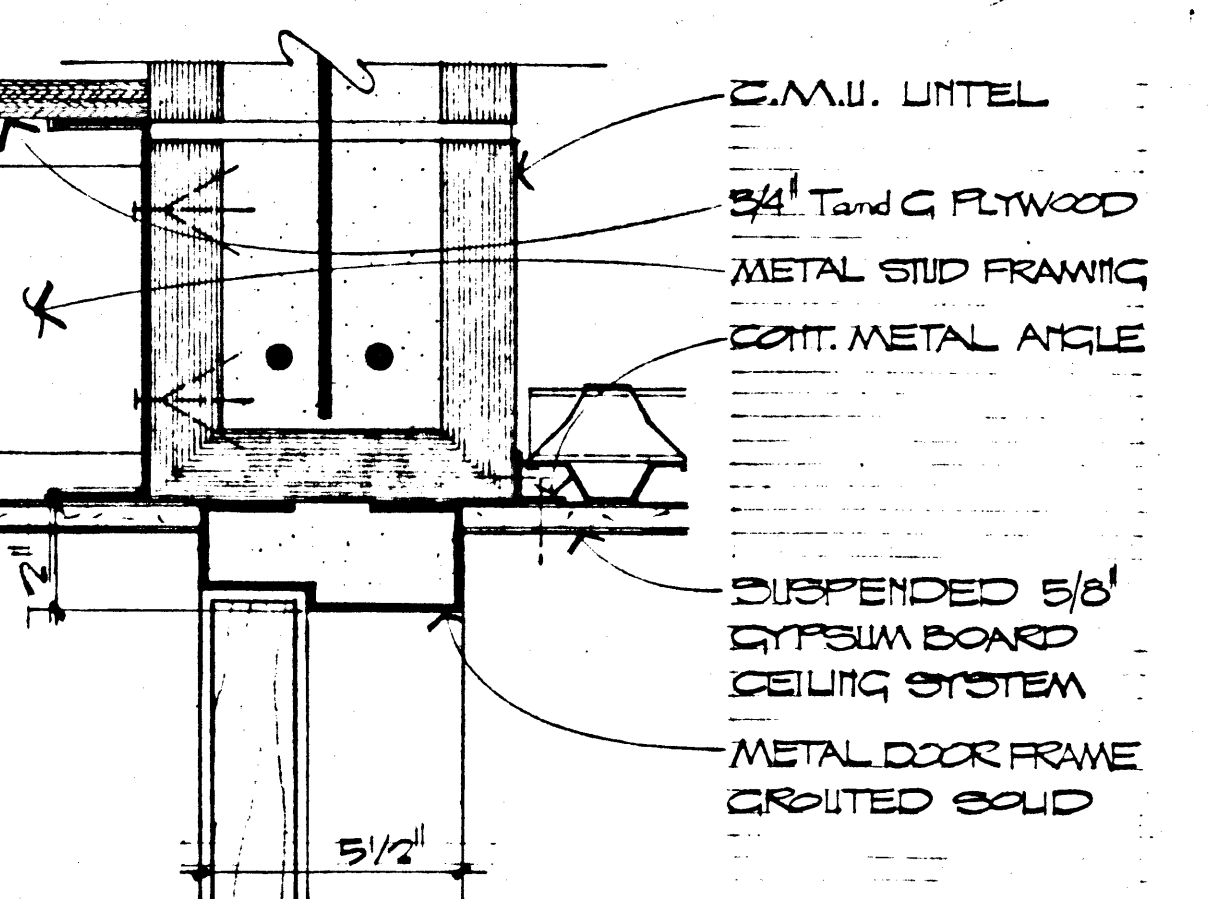

HEAD
SCALE: 8" = 1'-0"
5
A-7

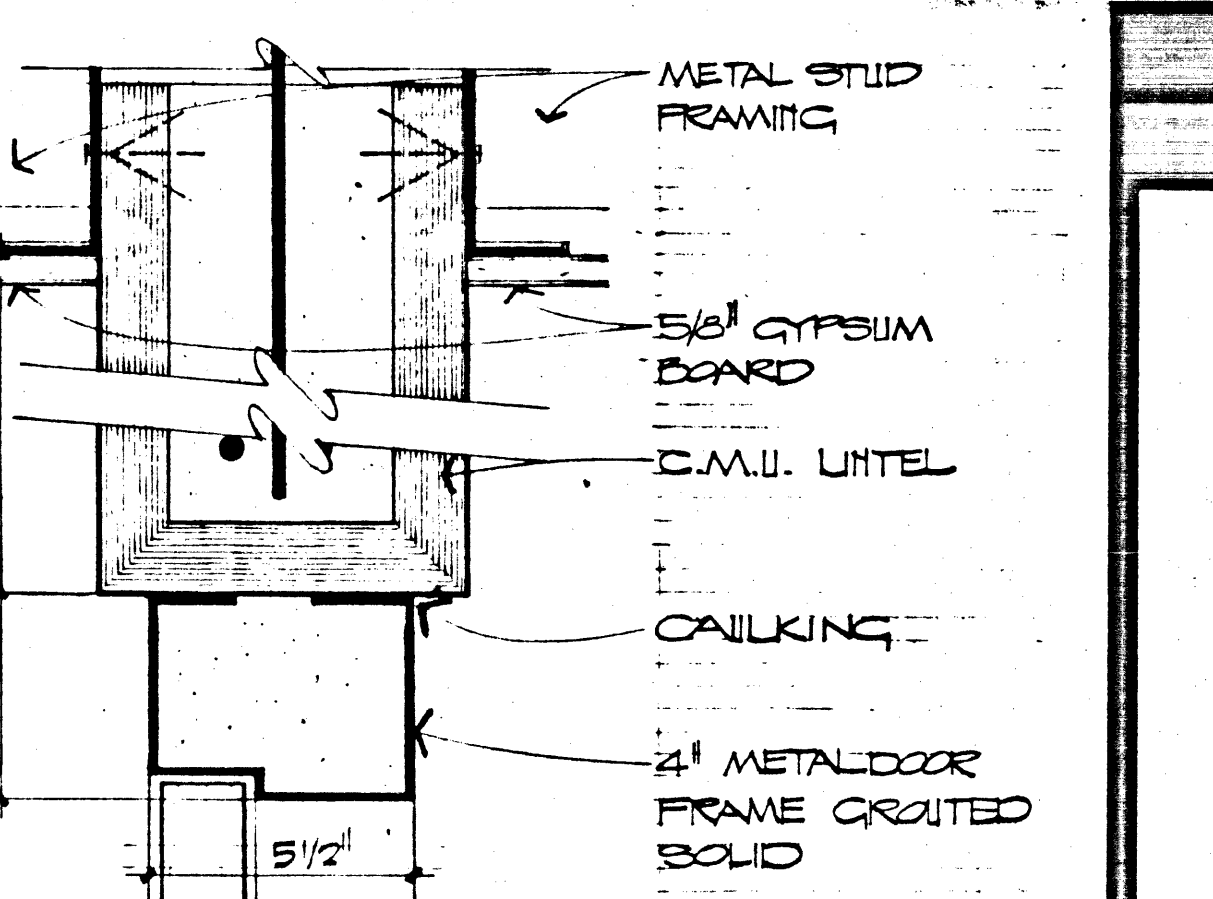

HEAD
SCALE: 8" = 1'-0"
6
A-7

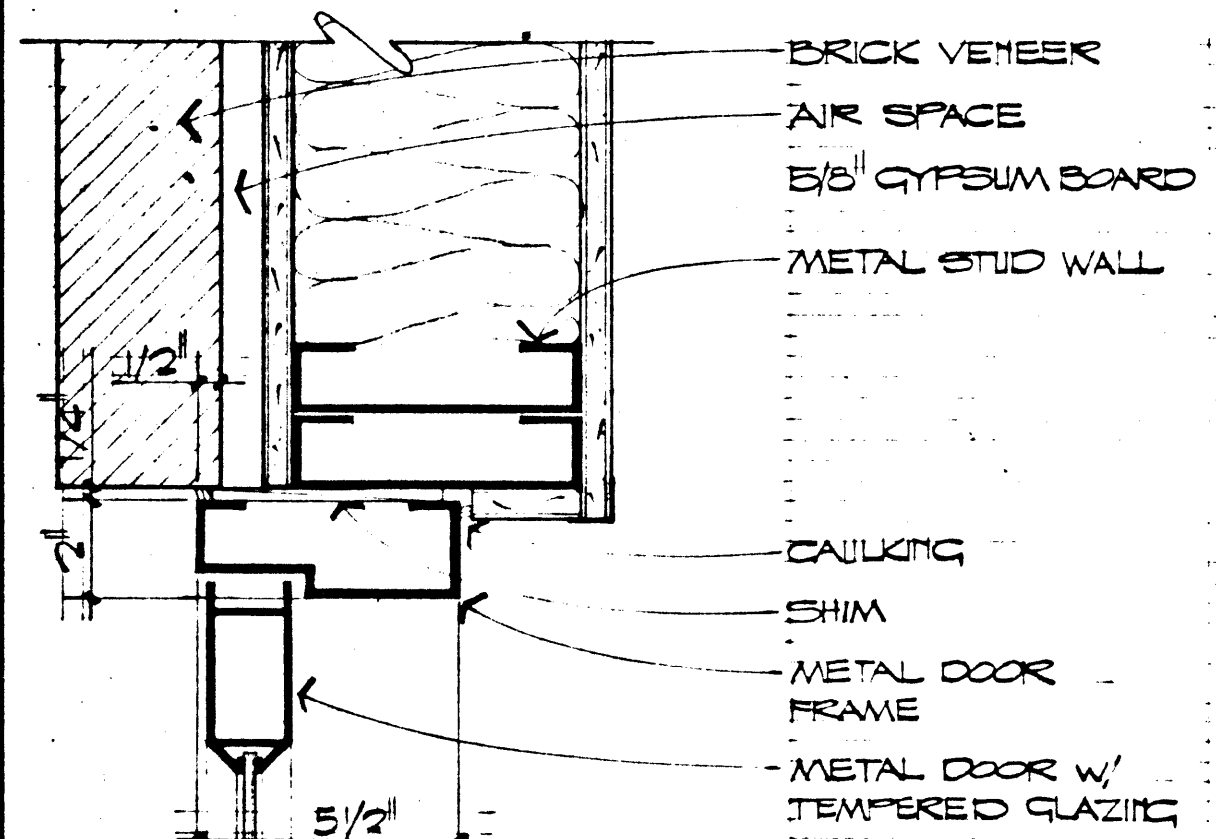

JAMB
SCALE: 8" = 1'-0"
7
A-7

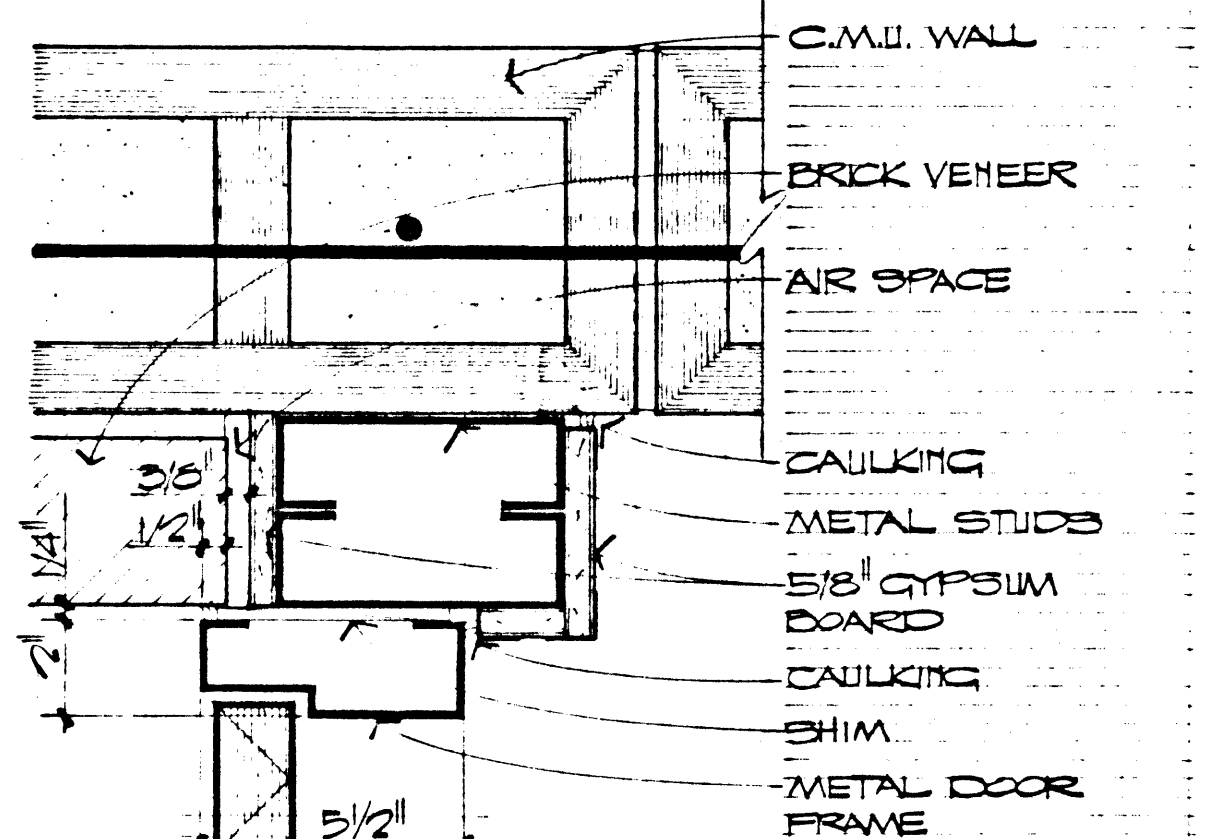

JAMB
SCALE: 8" = 1'-0"
8
A-7

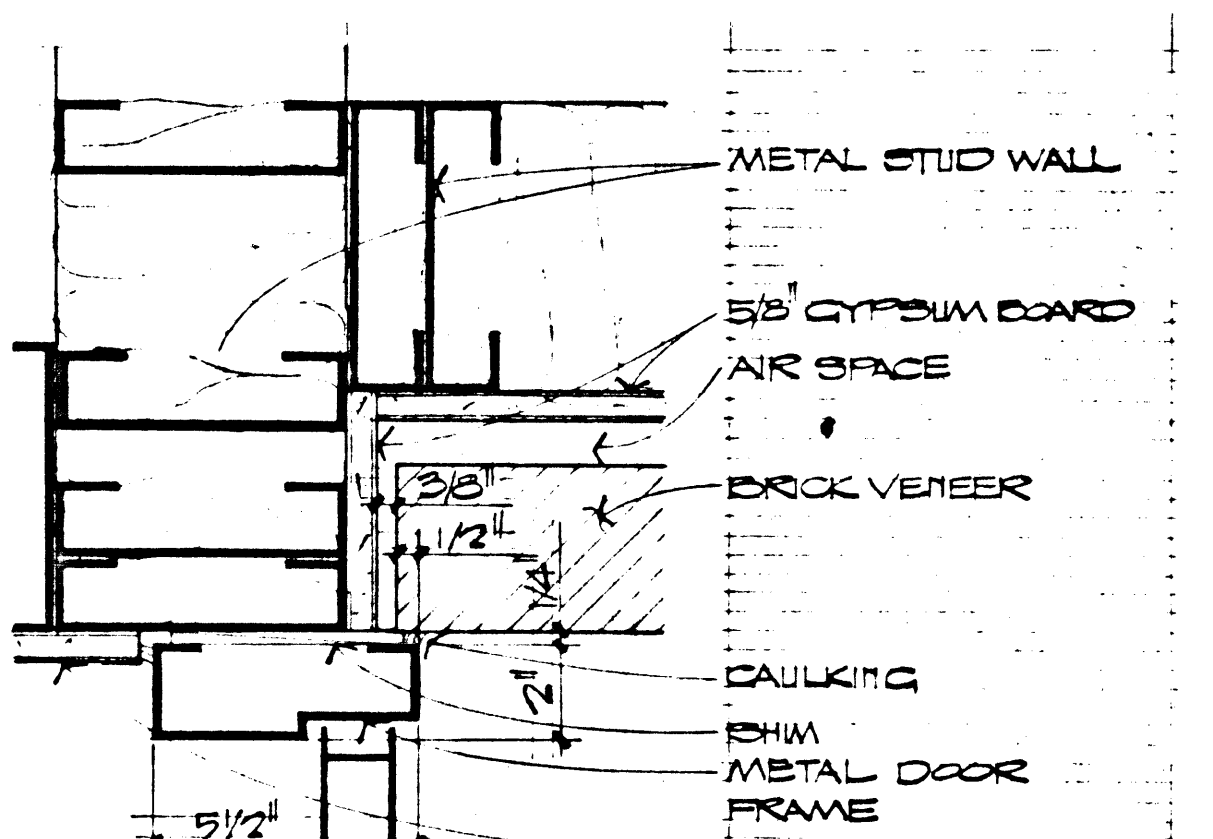

JAMB
SCALE: 8" = 1'-0"
9
A-7

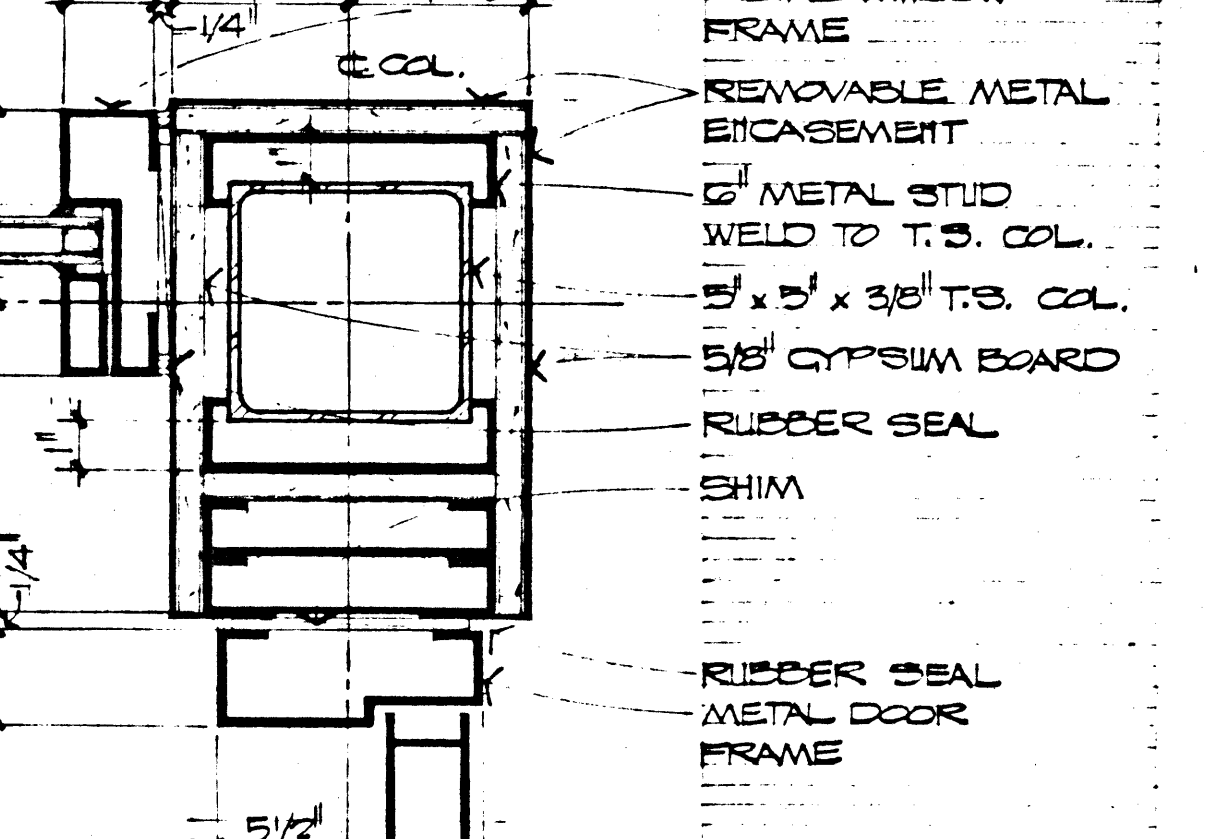

JAMB
SCALE: 8" = 1'-0"
10
A-7

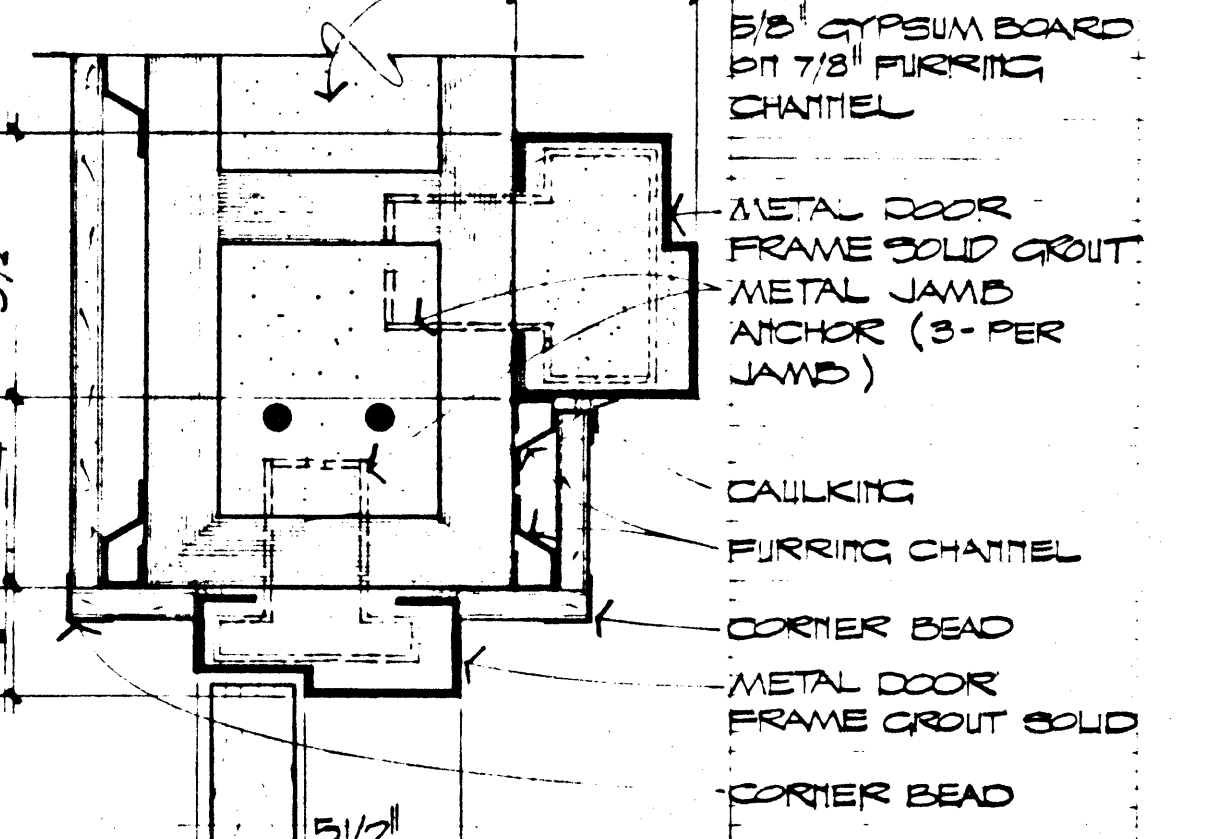

JAMB
SCALE: 8" = 1'-0"
11
A-7

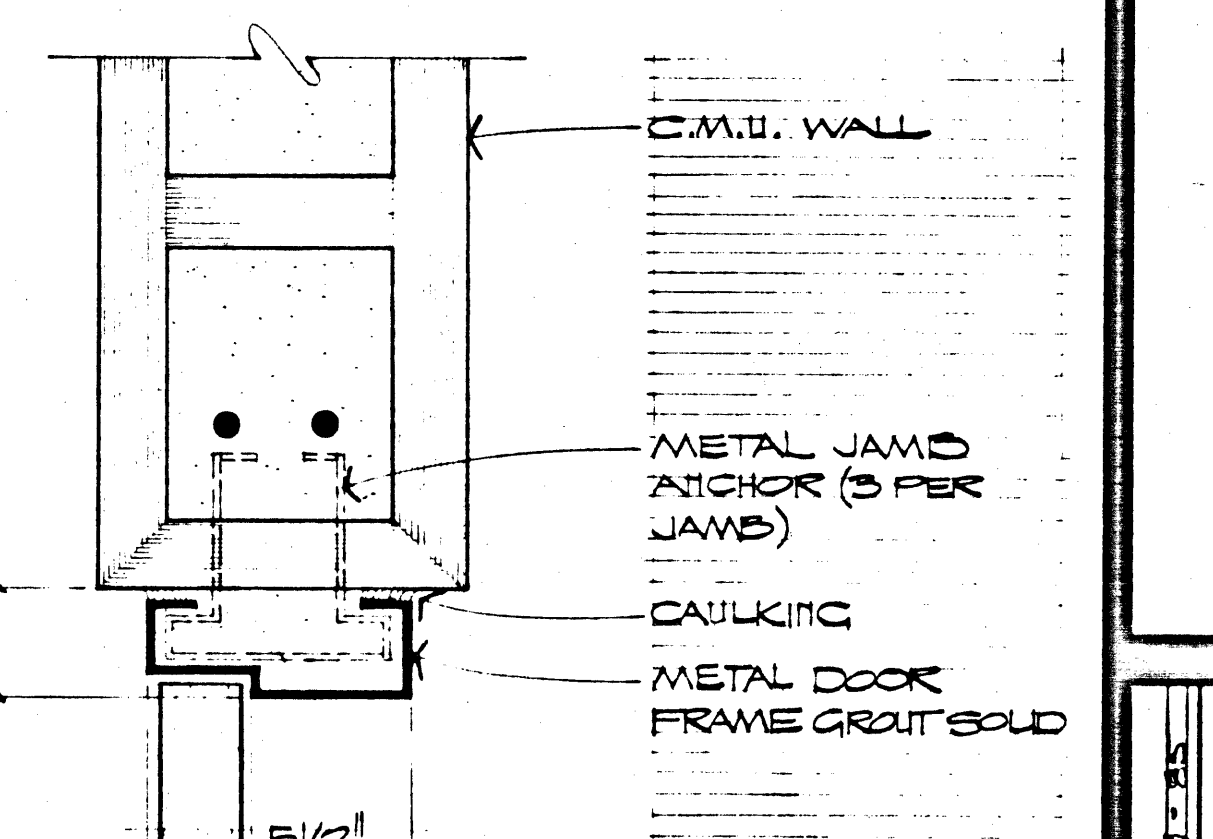

JAMB
SCALE: 8" = 1'-0"
12
A-7

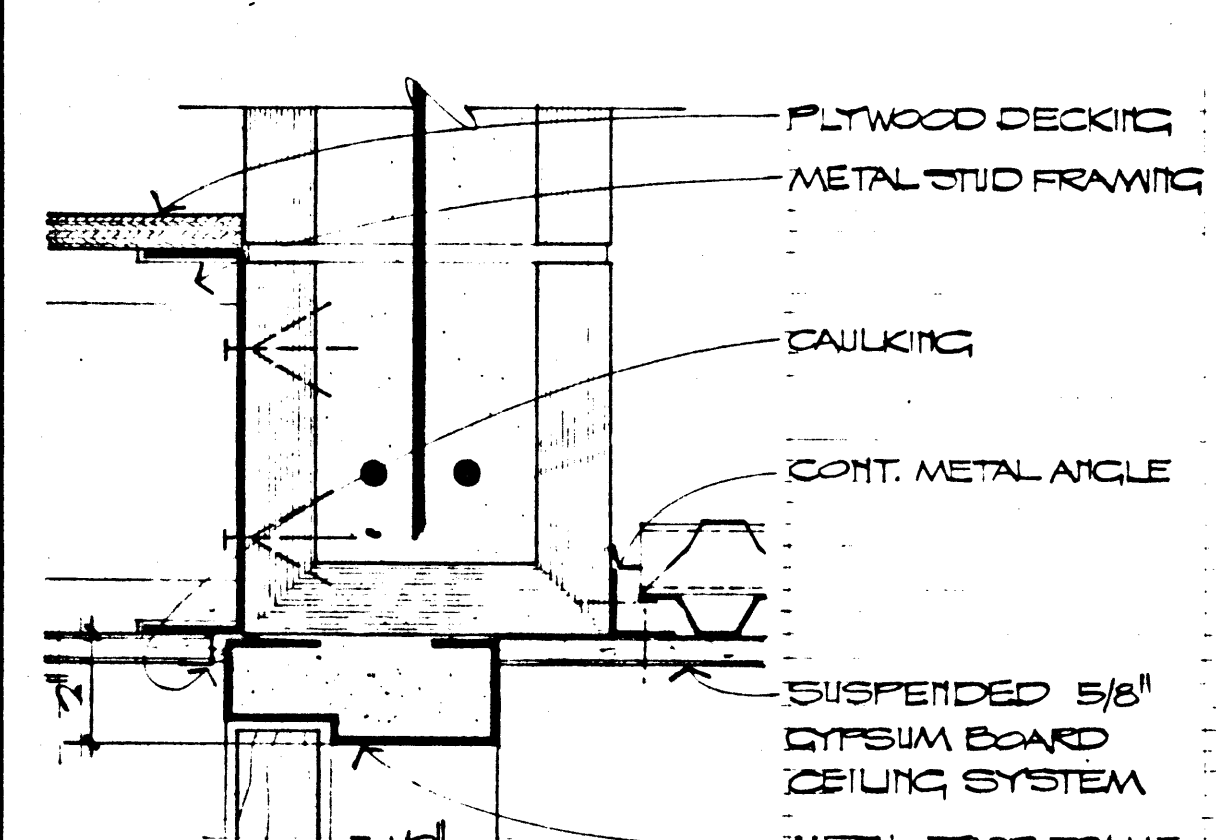

HEAD
SCALE: 8" = 1'-0"
13
A-7

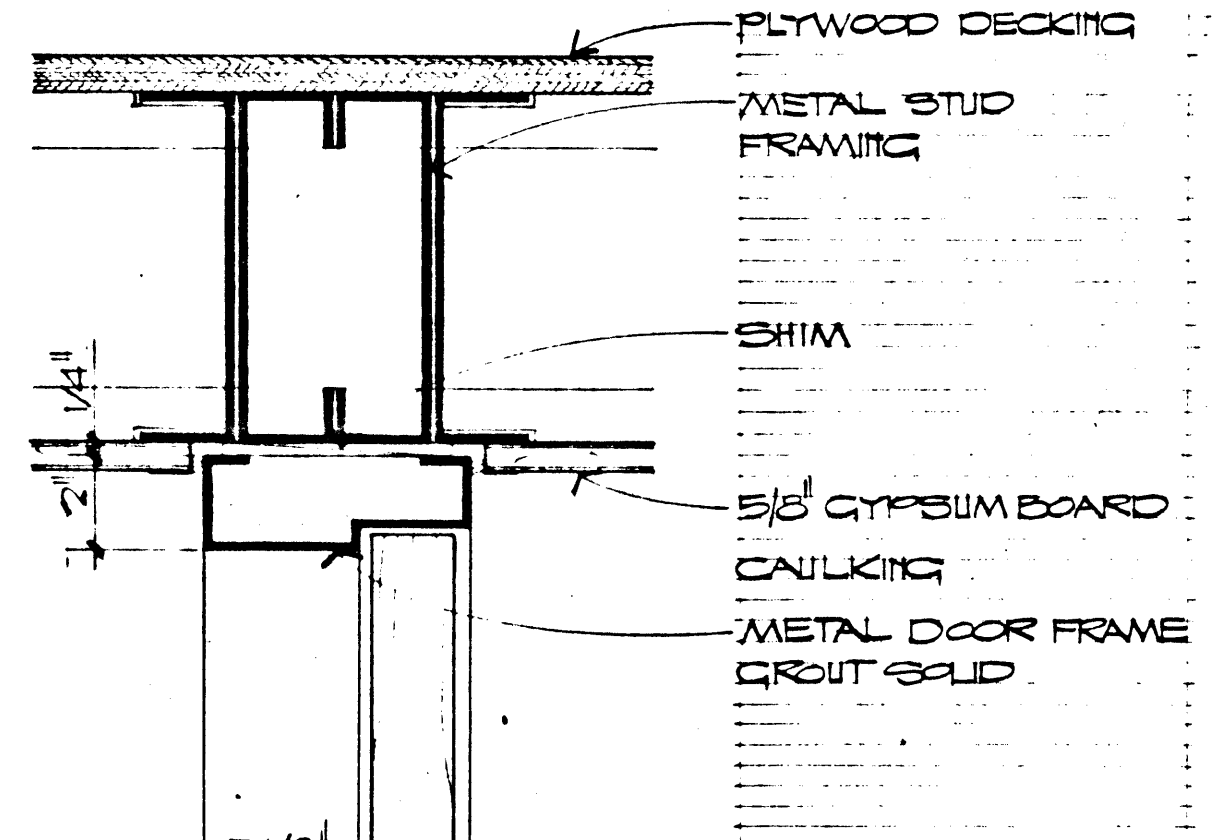

HEAD
SCALE: 8" = 1'-0"
14
A-7

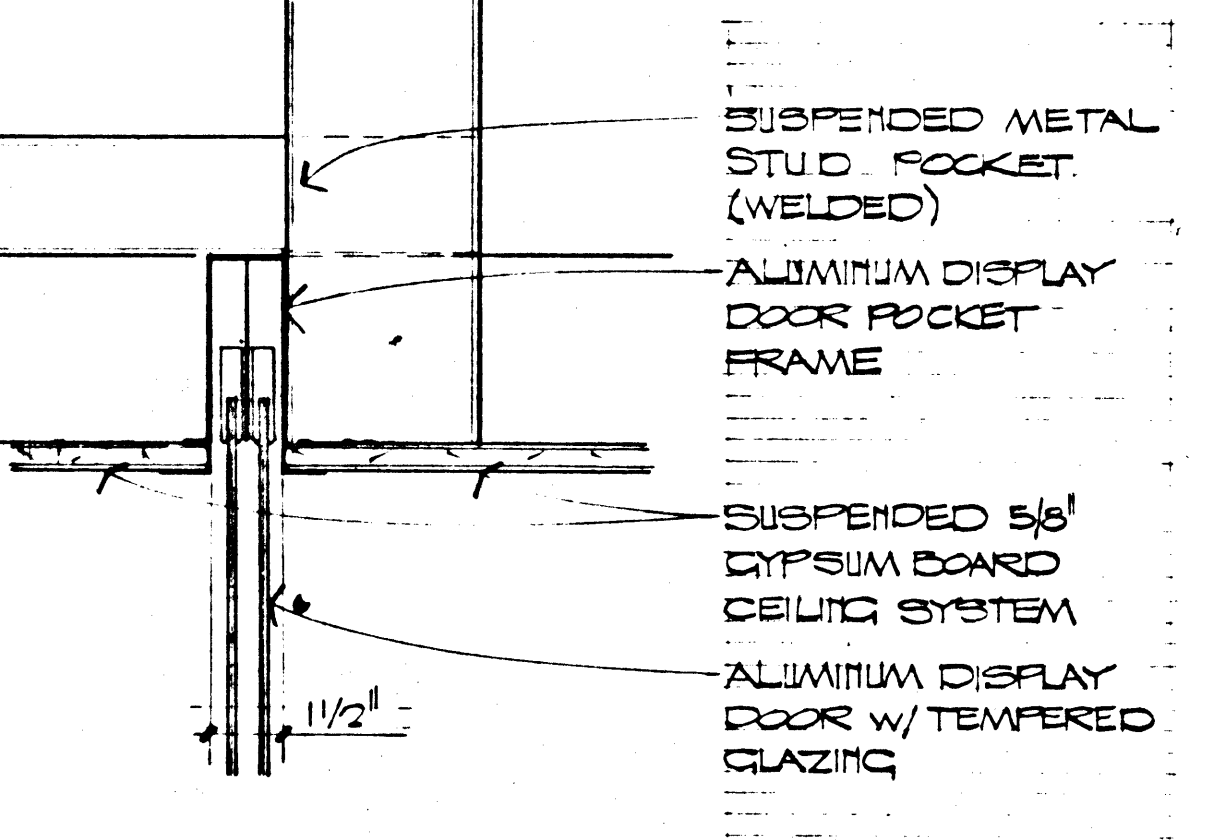

HEAD
SCALE: 8" = 1'-0"
15
A-7

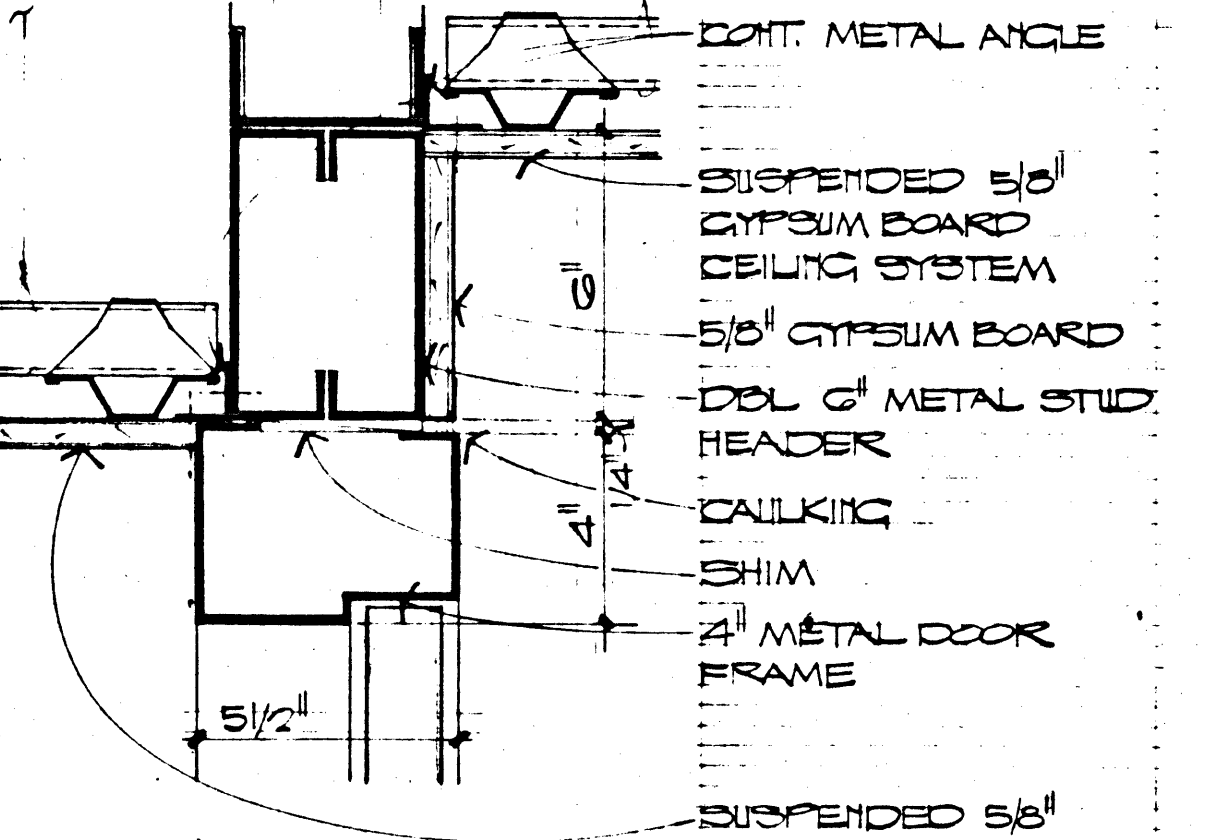

HEAD
SCALE: 8" = 1'-0"
16
A-7

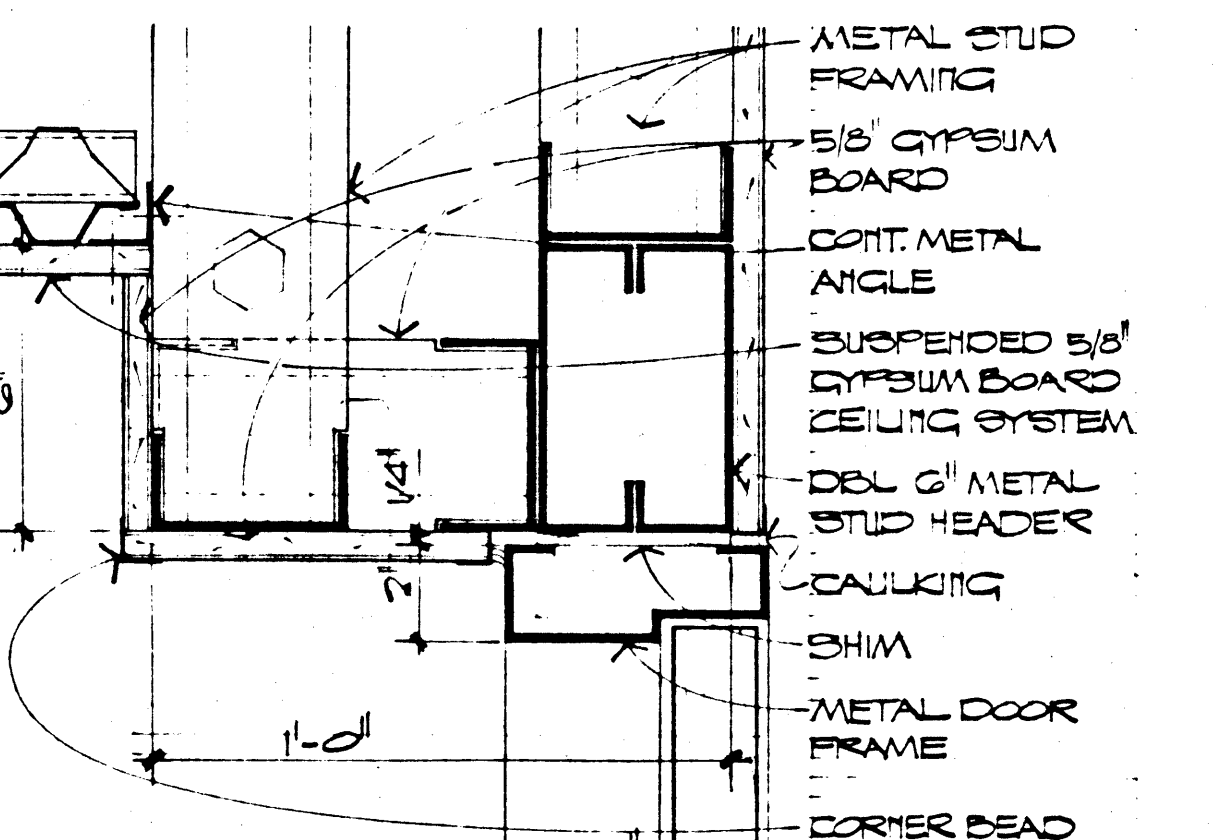

HEAD
SCALE: 8" = 1'-0"
17
A-7

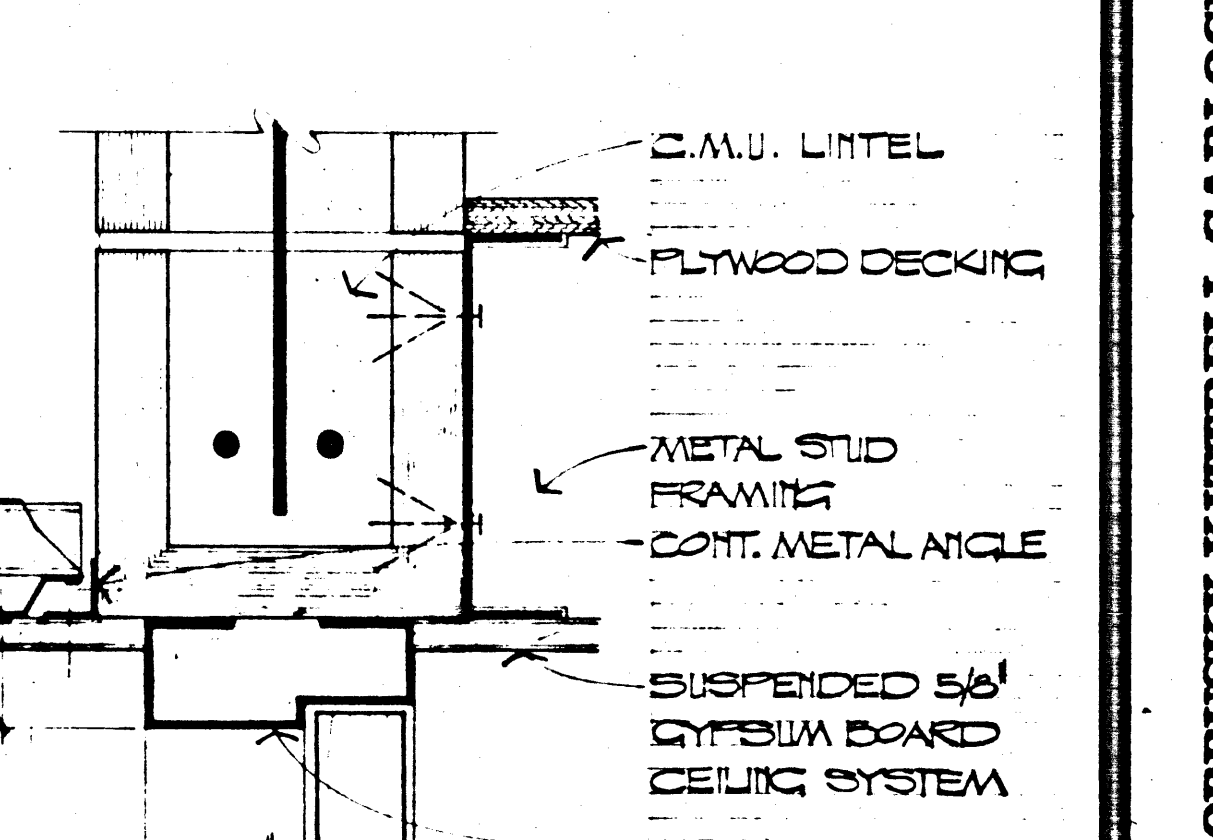

HEAD
SCALE: 8" = 1'-0"
18
A-7

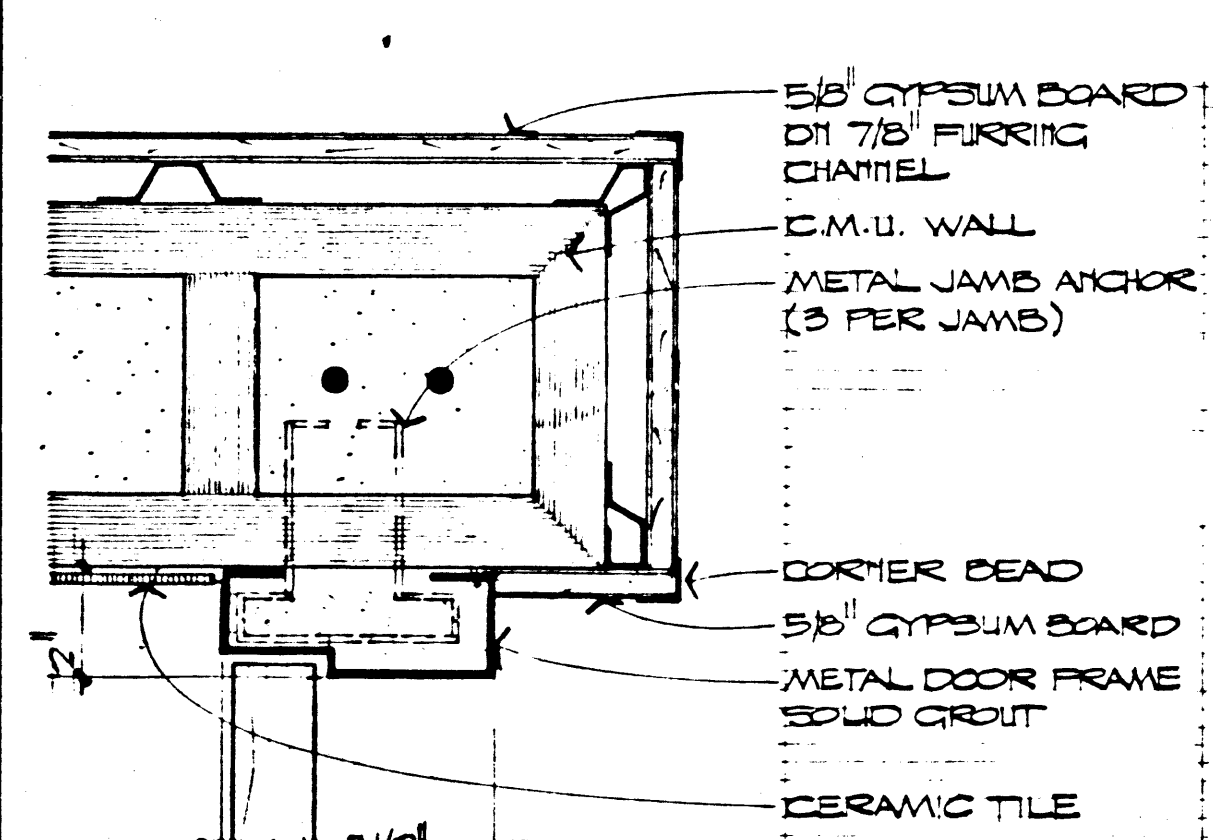

JAMB
SCALE: 8" = 1'-0"
19
A-7

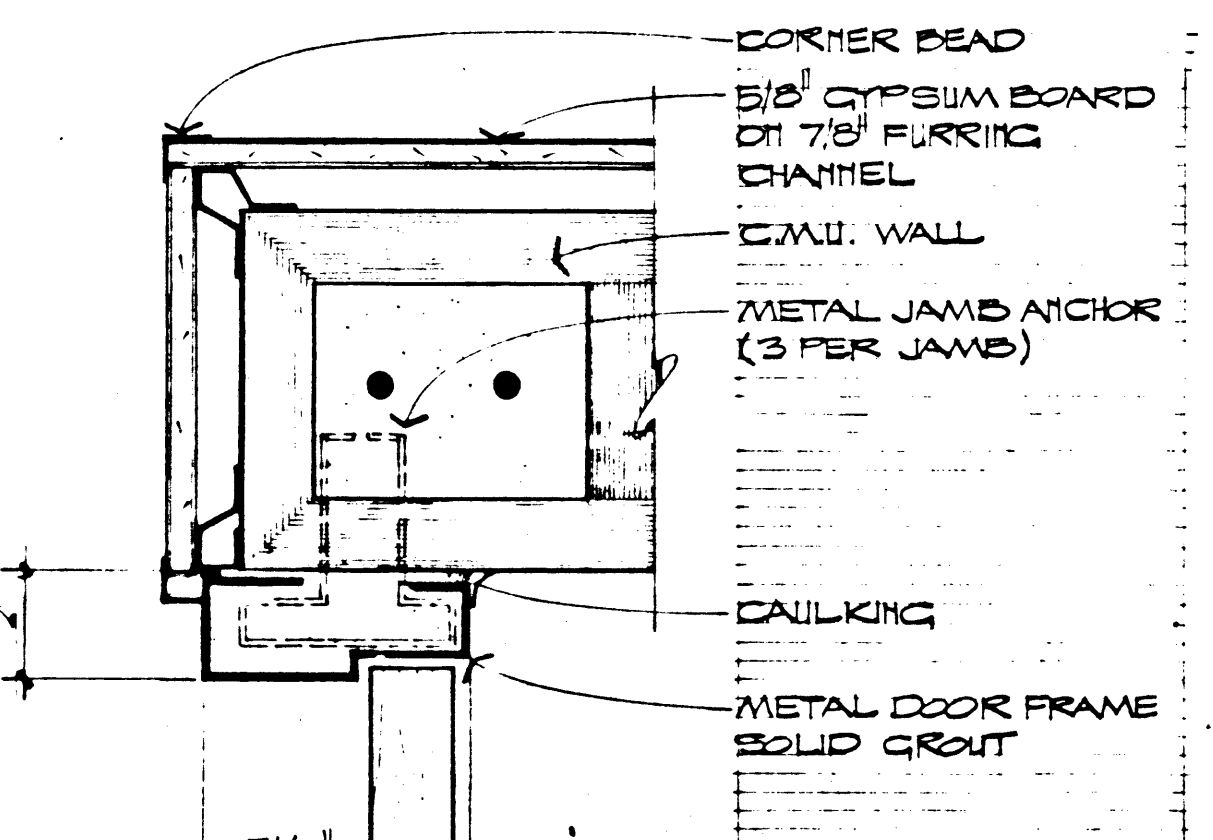

JAMB
SCALE: 8" = 1'-0"
20
A-7

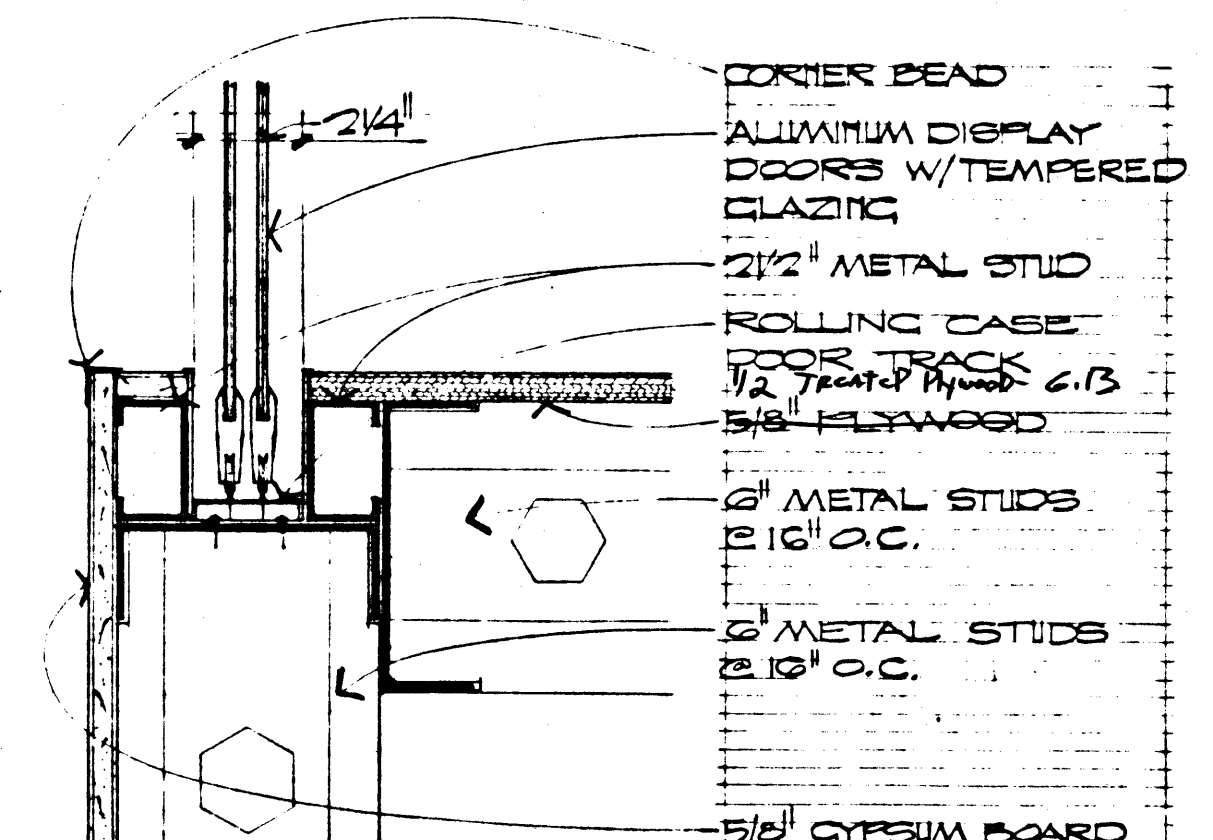

SILL
SCALE: 8" = 1'-0"
21
A-7

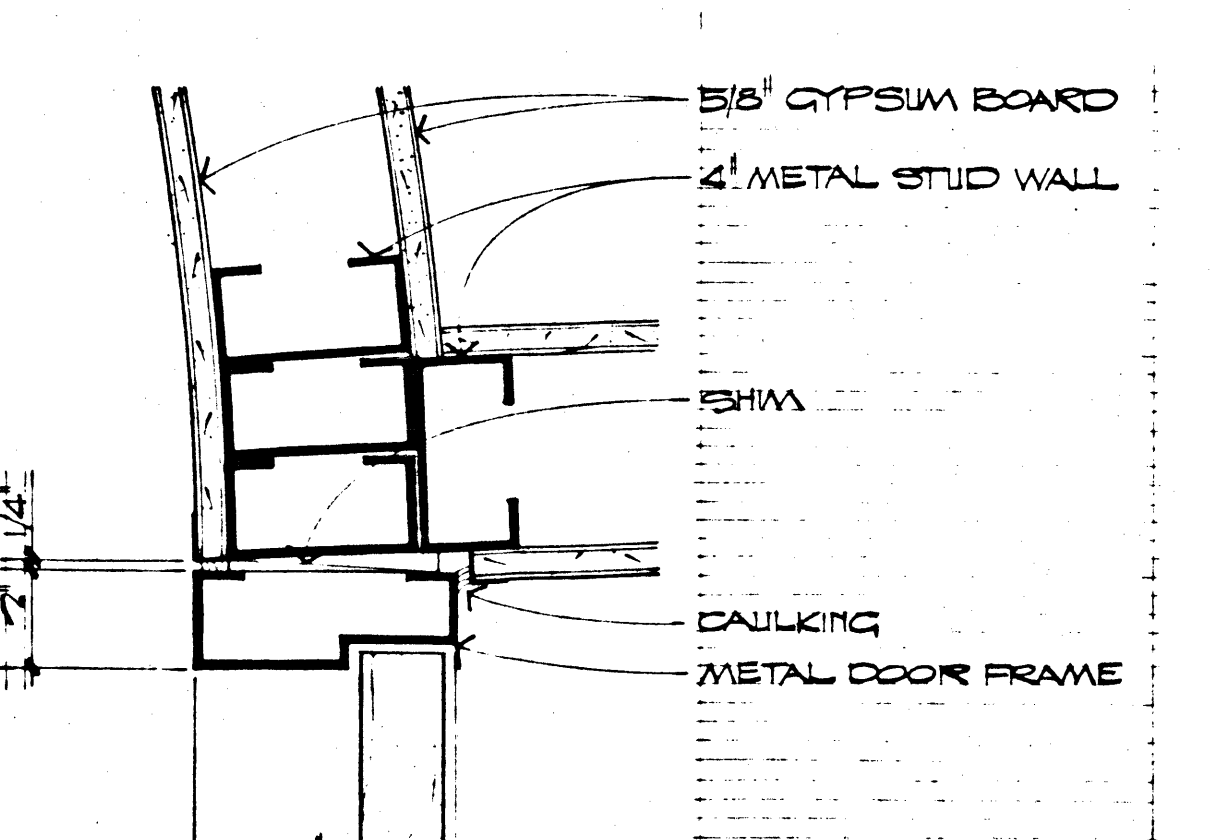

JAMB
SCALE: 8" = 1'-0"
22
A-7

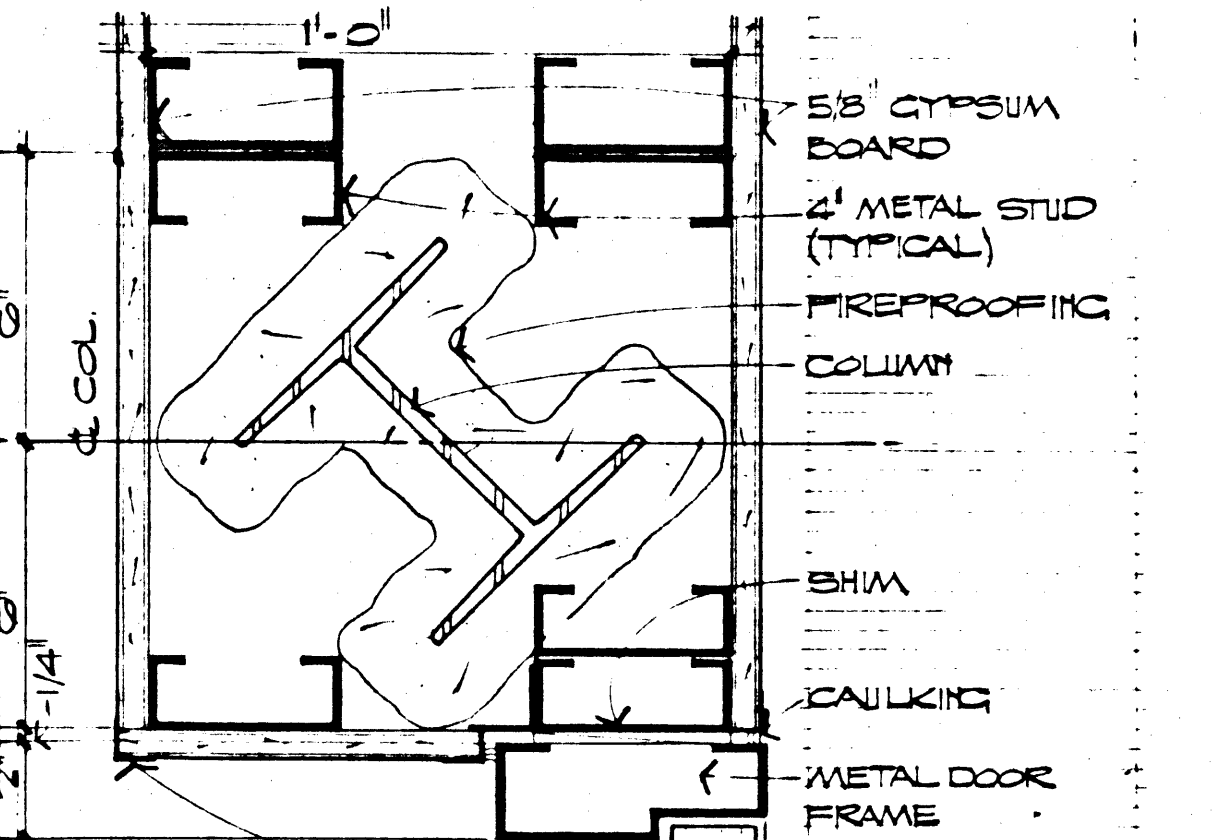

JAMB
SCALE: 8" = 1'-0"
23
A-7

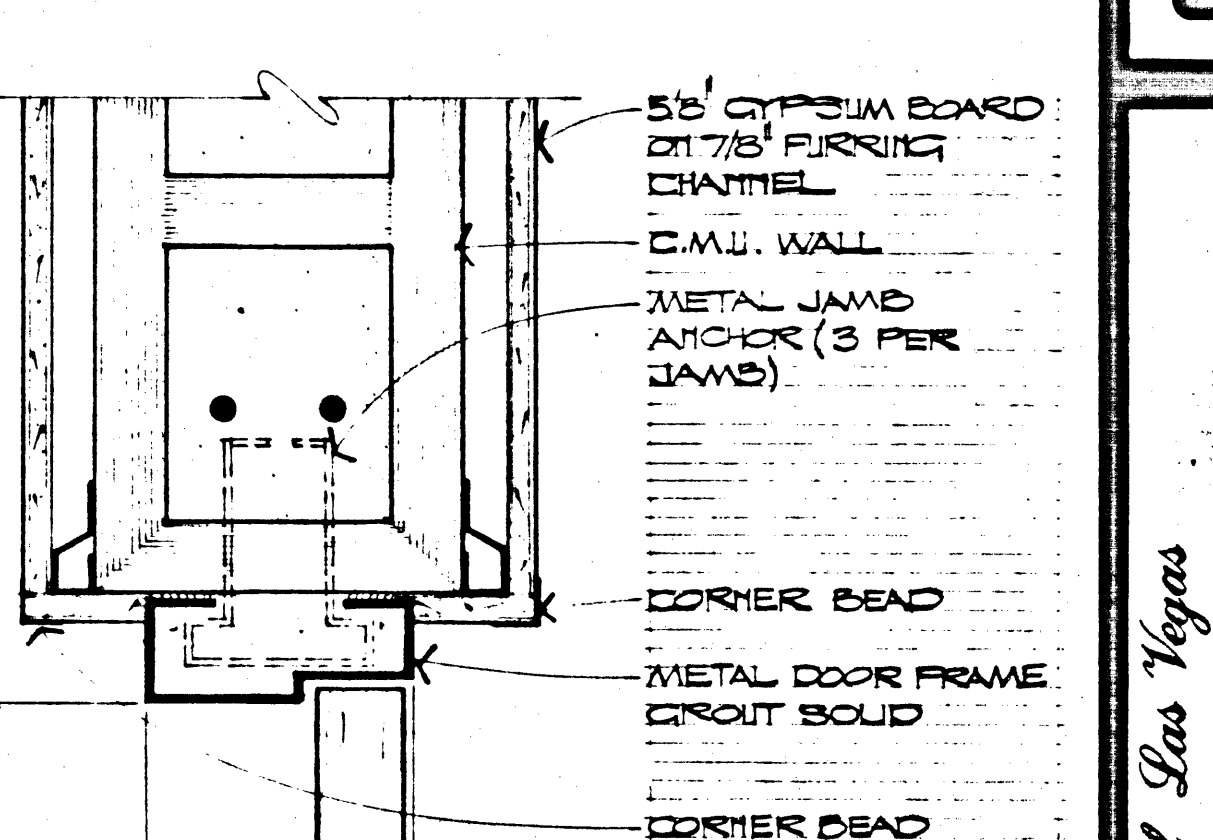

JAMB
SCALE: 8" = 1'-0"
24
A-7

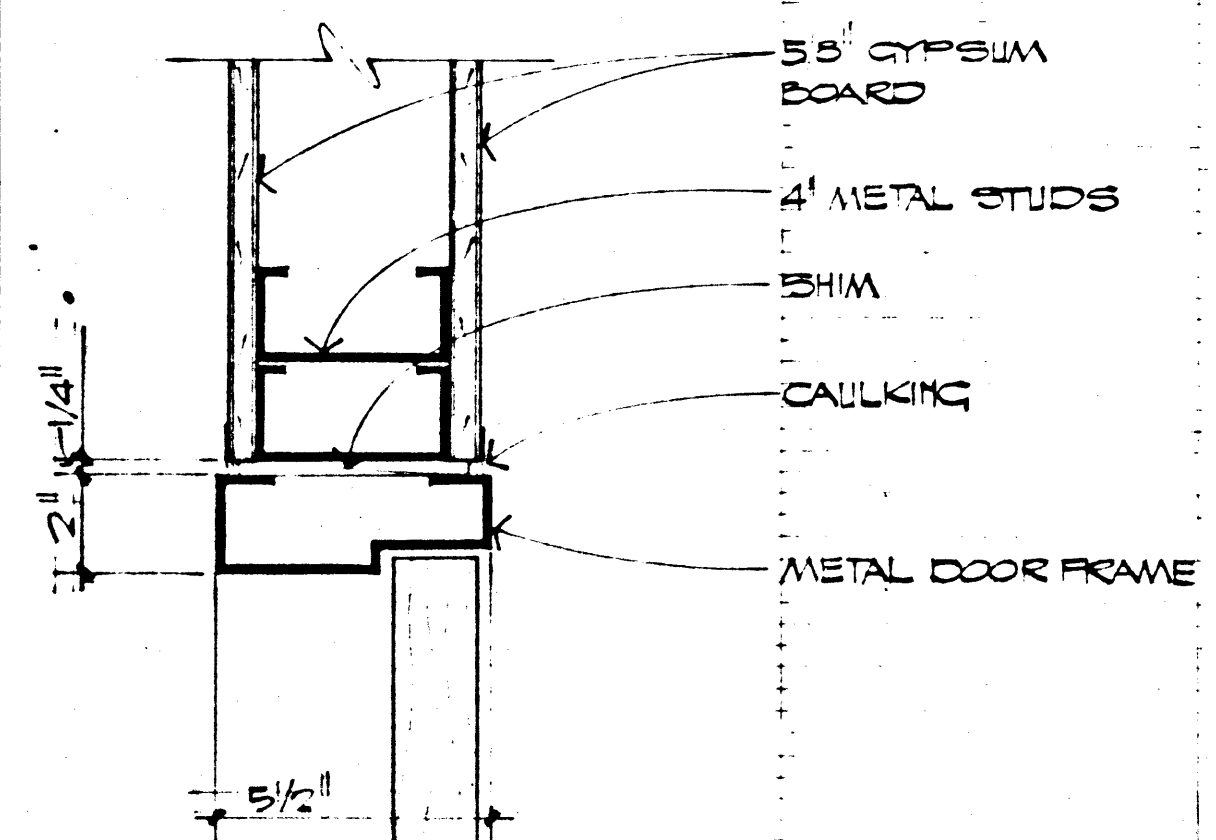

JAMB
SCALE: 8" = 1'-0"
25
A-7

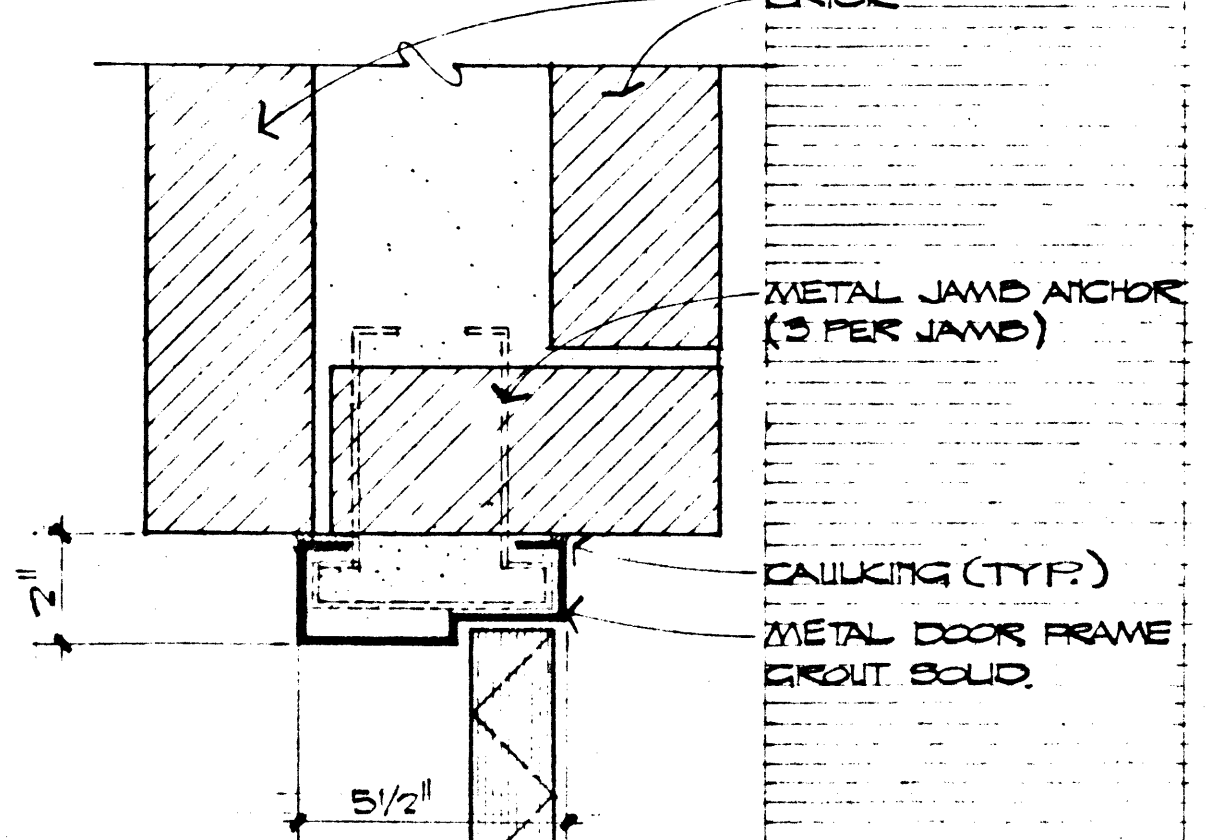

JAMB
SCALE: 8" = 1'-0"
26
A-7

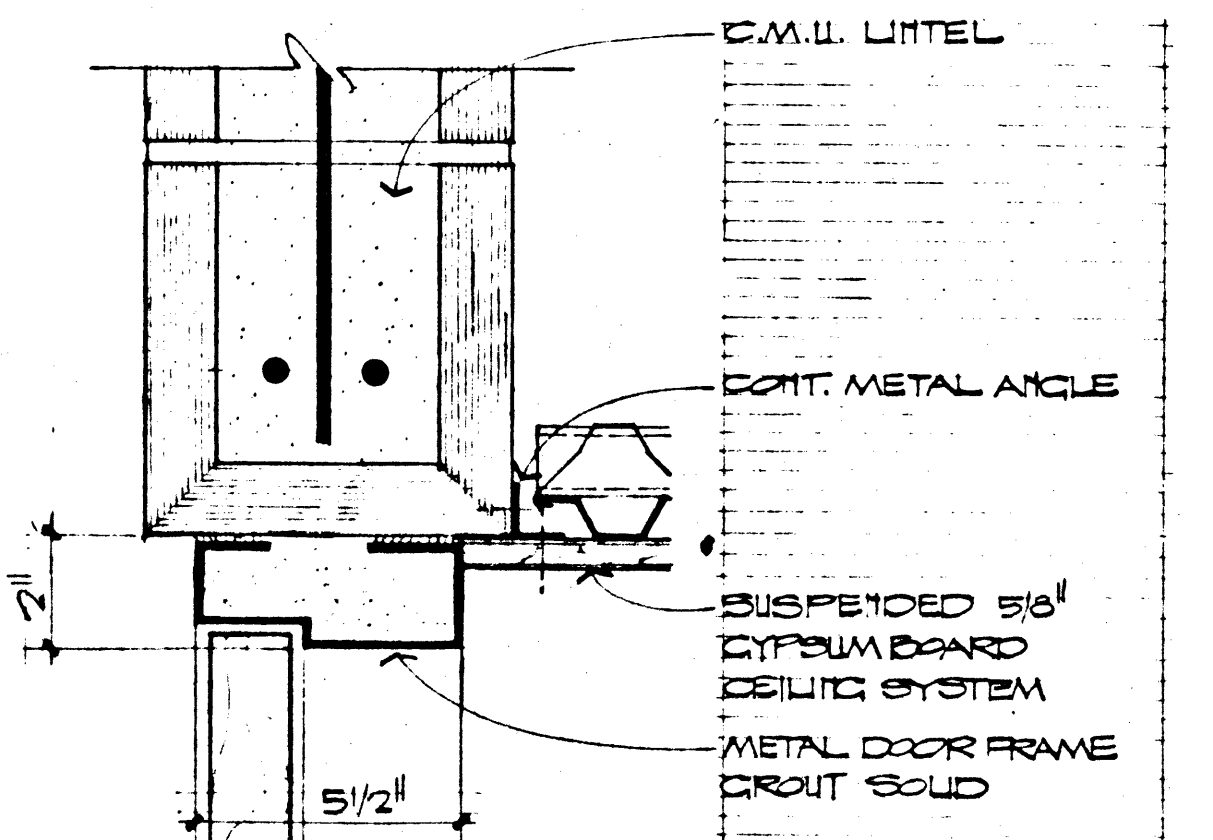

HEAD
SCALE: 8" = 1'-0"
27
A-7

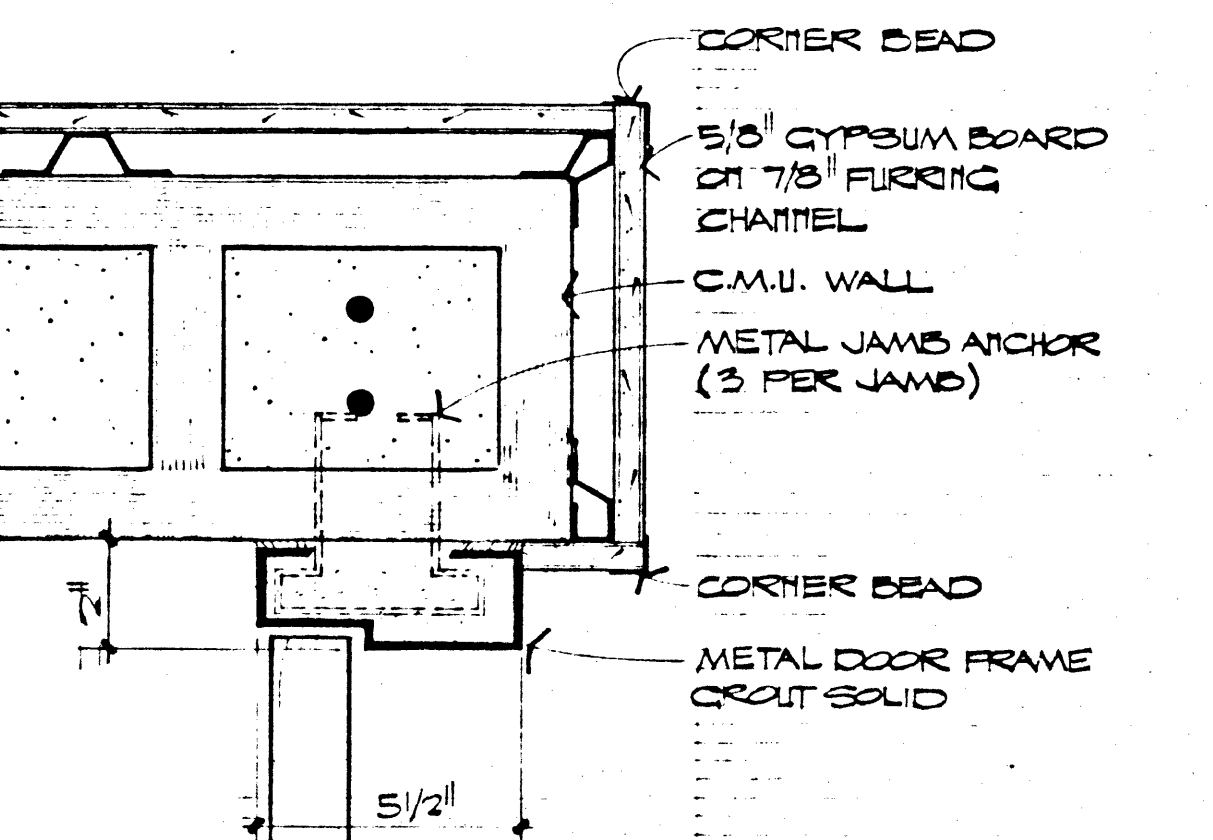

JAMB
SCALE: 8" = 1'-0"
28
A-7

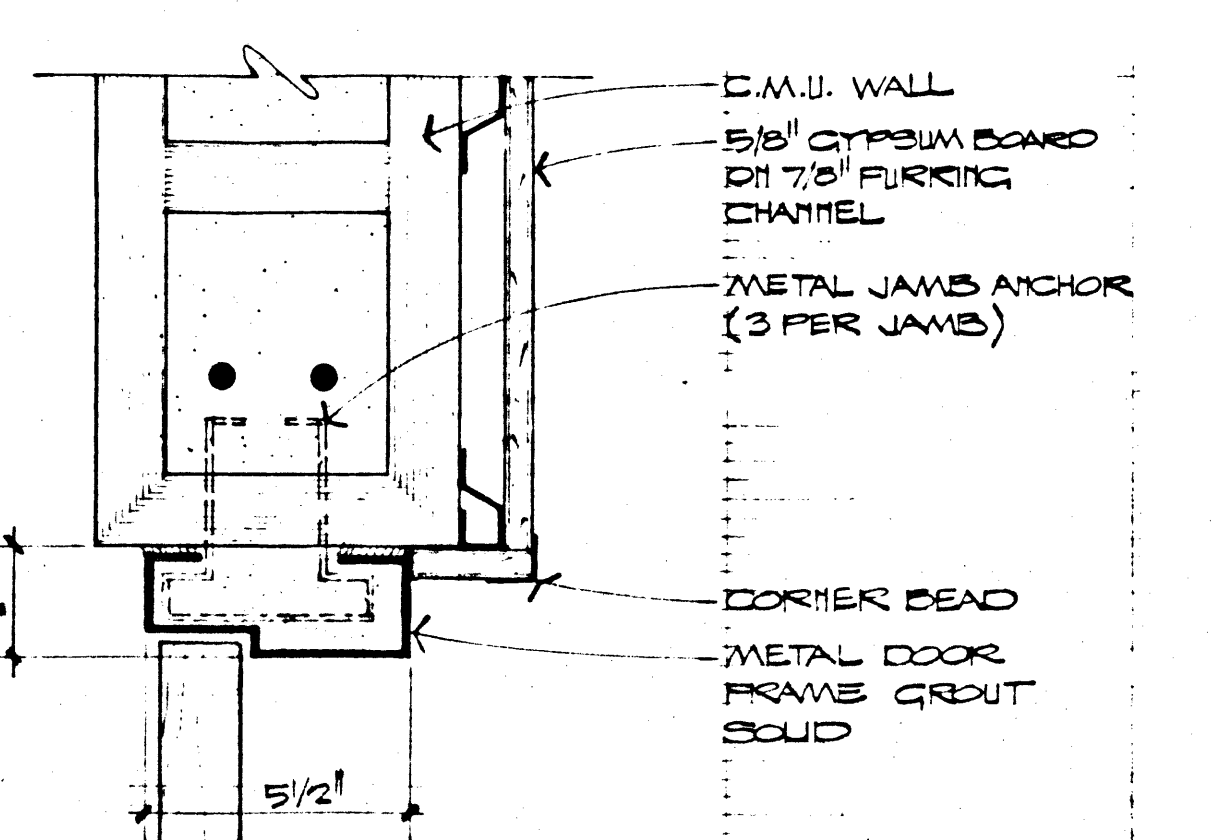

JAMB
SCALE: 8" = 1'-0"
29
A-7

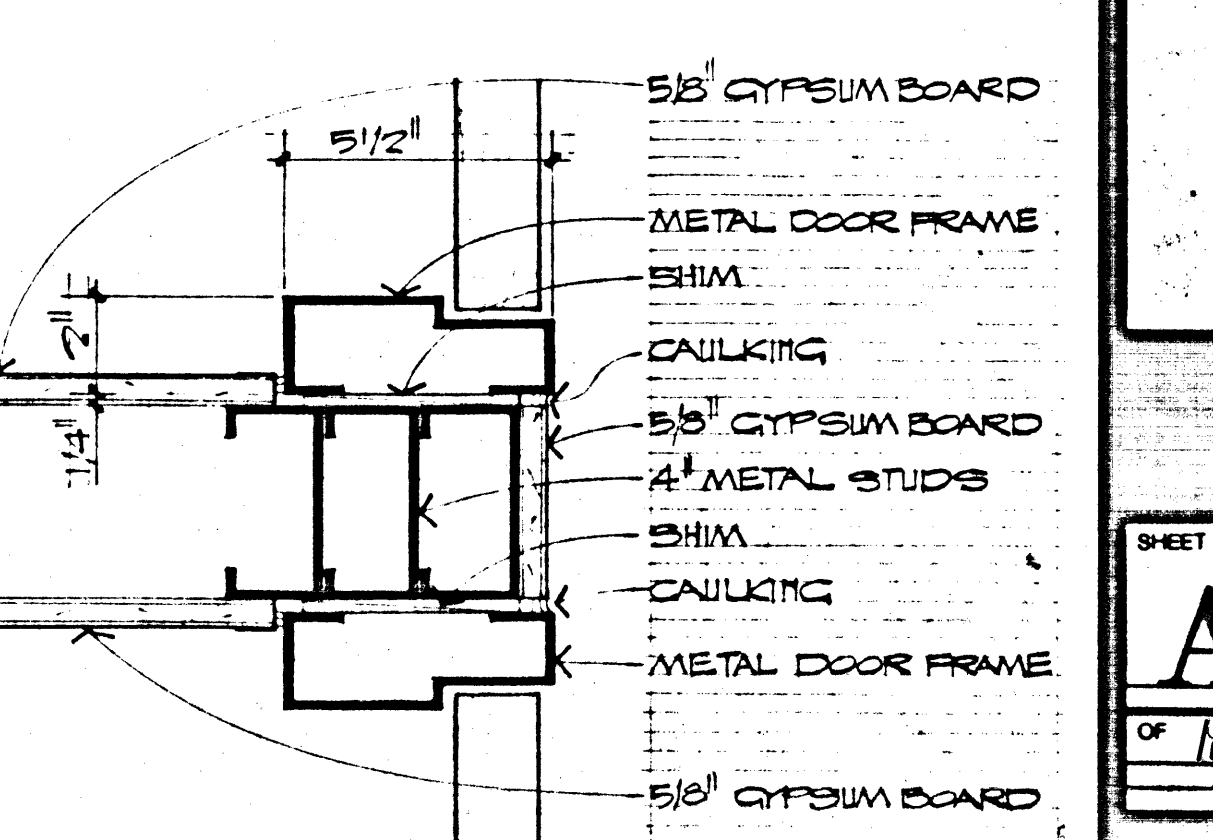

JAMB
SCALE: 8" = 1'-0"
30
A-7

DATE: 11-15-15
DRAWN: J. B. B.
CHECKED: J. B. B.
JOB NO: 15-011
SHEET NO: 11

DOBUSKY KITRELL GARLOCK
Architects
888 CAROLINE ST. LAS VEGAS, NEVADA 89101 (702) 781-0485

City of Las Vegas
Center
Transportation
Las Vegas, Nevada
Downtown

SHEET
A-7
of 16 sheets
FILE NUMBER
1530-2-J