

FOR ADDITIONAL DESIGN REQUIREMENTS SEE USD #236

A

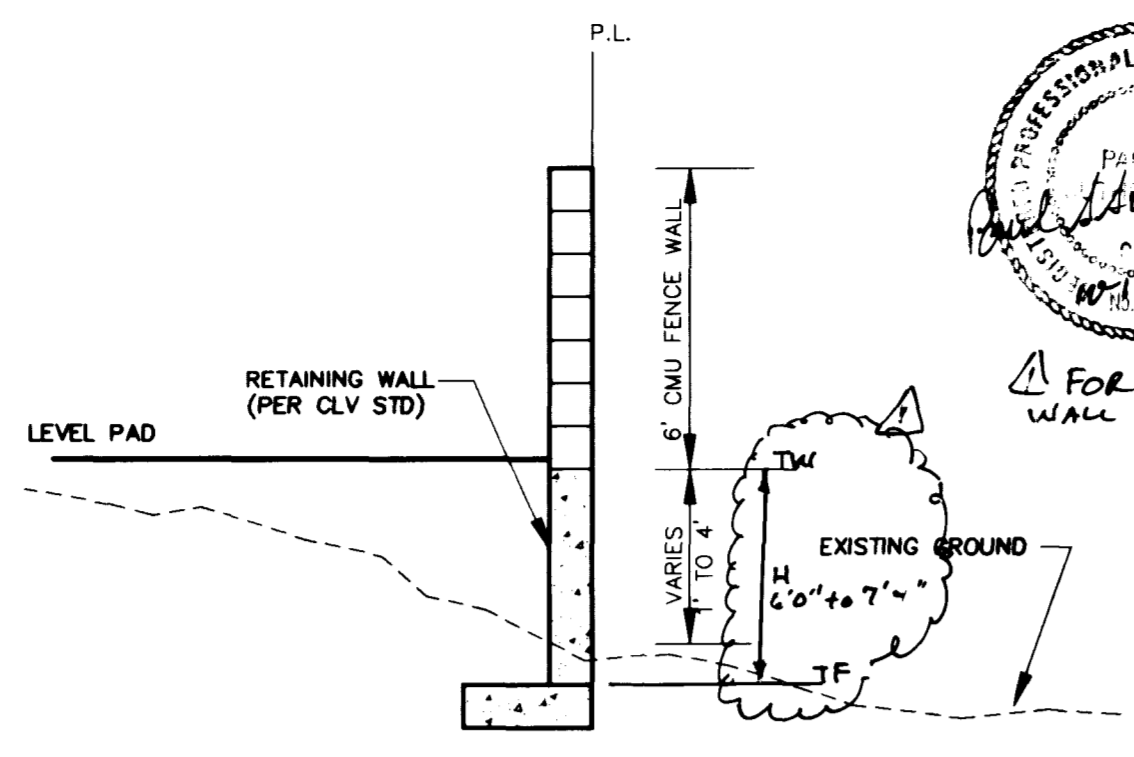

12 REAR YARD PERIMETER DETAIL

SCALE: NO SCALE

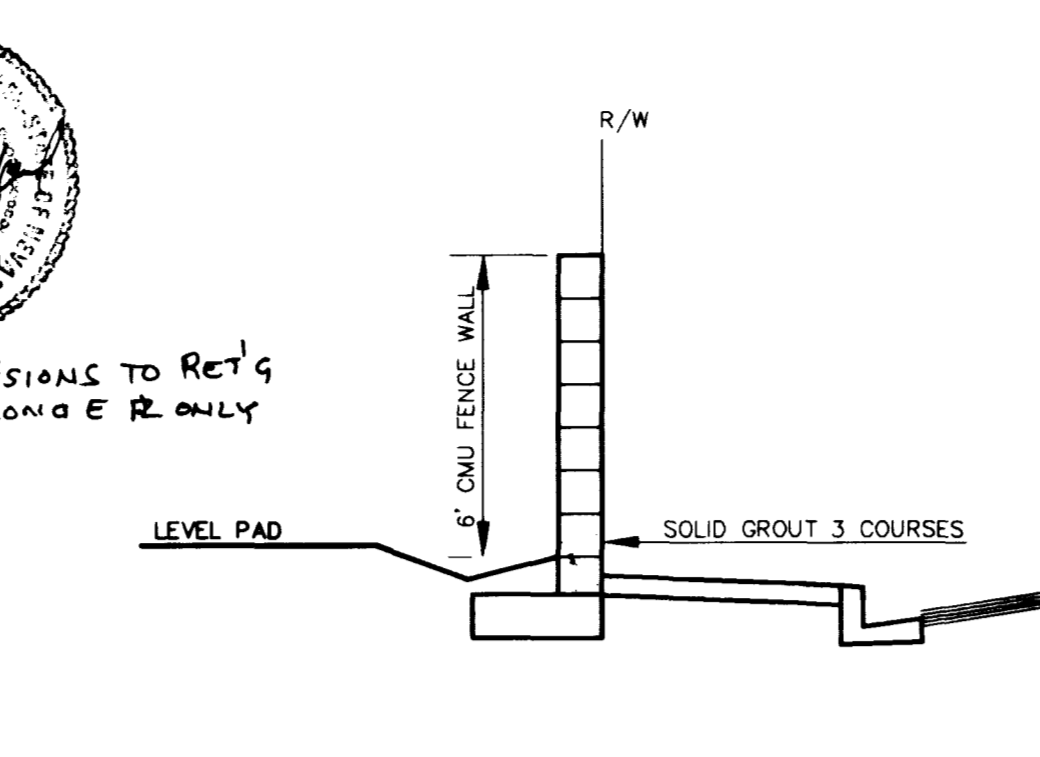

8 REAR YARD PERIMETER DETAIL

SCALE: NO SCALE

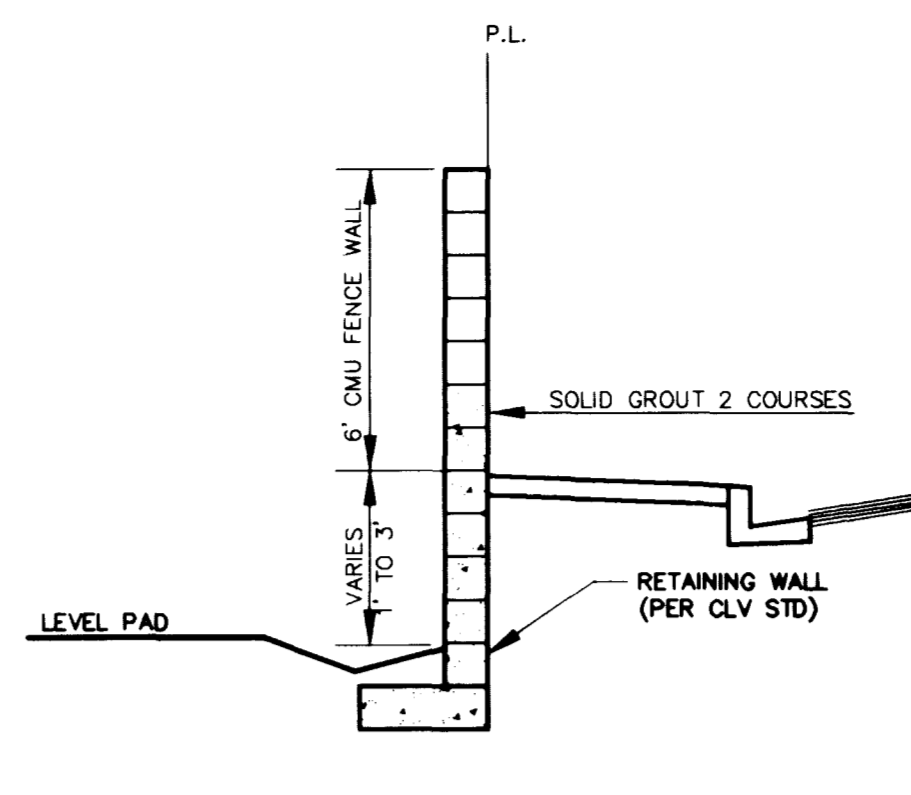

4 SIDE YARD WITH RETAINING DETAIL

SCALE: NO SCALE

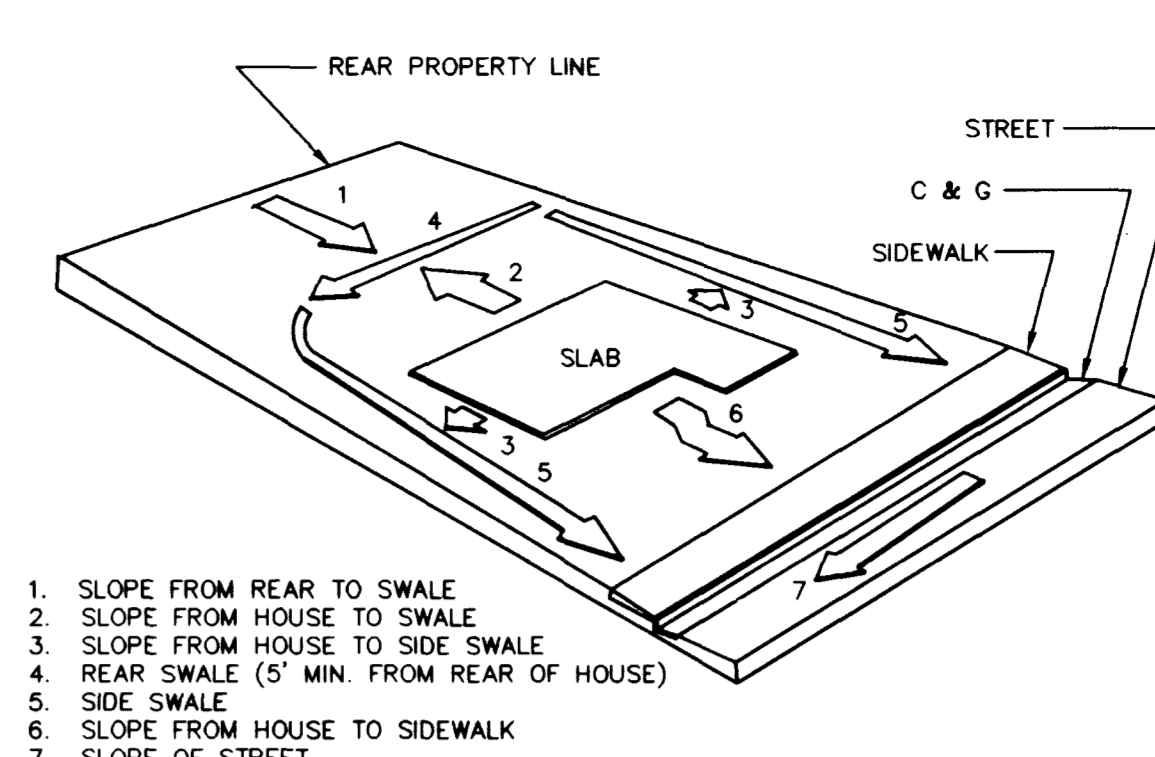

1. SLOPE FROM REAR TO SWALE
2. SLOPE FROM HOUSE TO SWALE
3. SLOPE FROM HOUSE TO SIDE SWALE
4. REAR SWALE (5' MIN. FROM REAR OF HOUSE)
5. SIDE SWALE
6. SLOPE FROM HOUSE TO SIDEWALK
7. SLOPE OF STREET

TYPICAL LOT GRADING - TYPE "A"

SCALE: N.T.S.

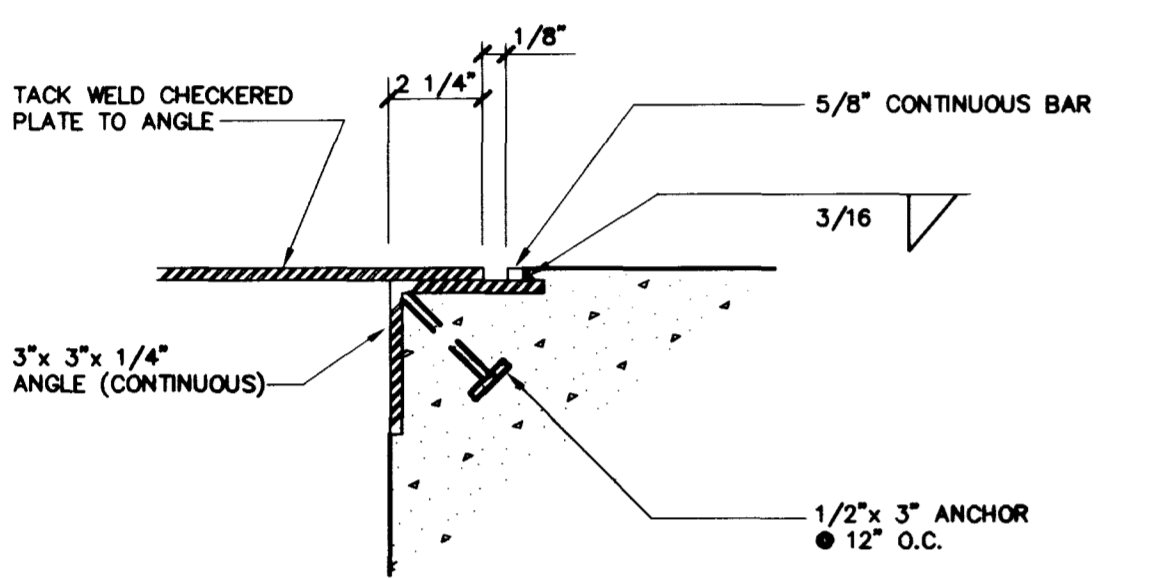

FOR ADDITIONAL DESIGN REQUIREMENTS SEE USD #236

B

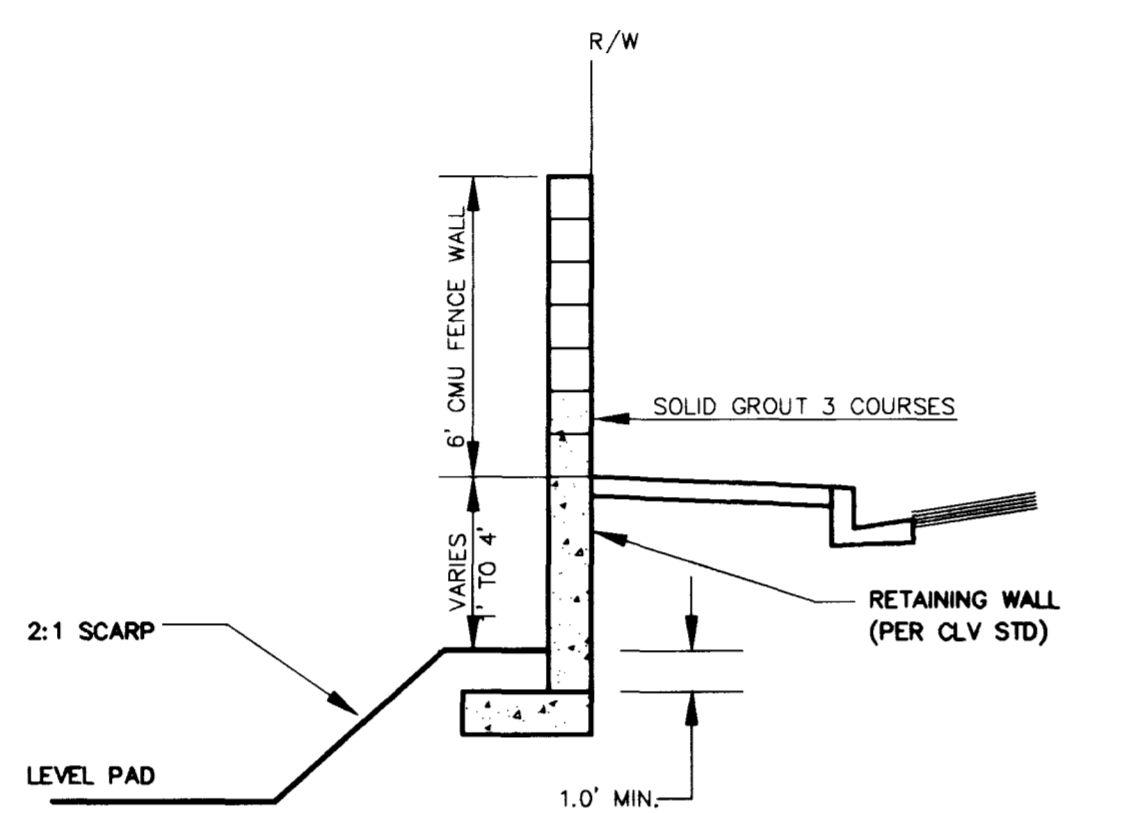

13 REAR YARD PERIMETER DETAIL

SCALE: NO SCALE

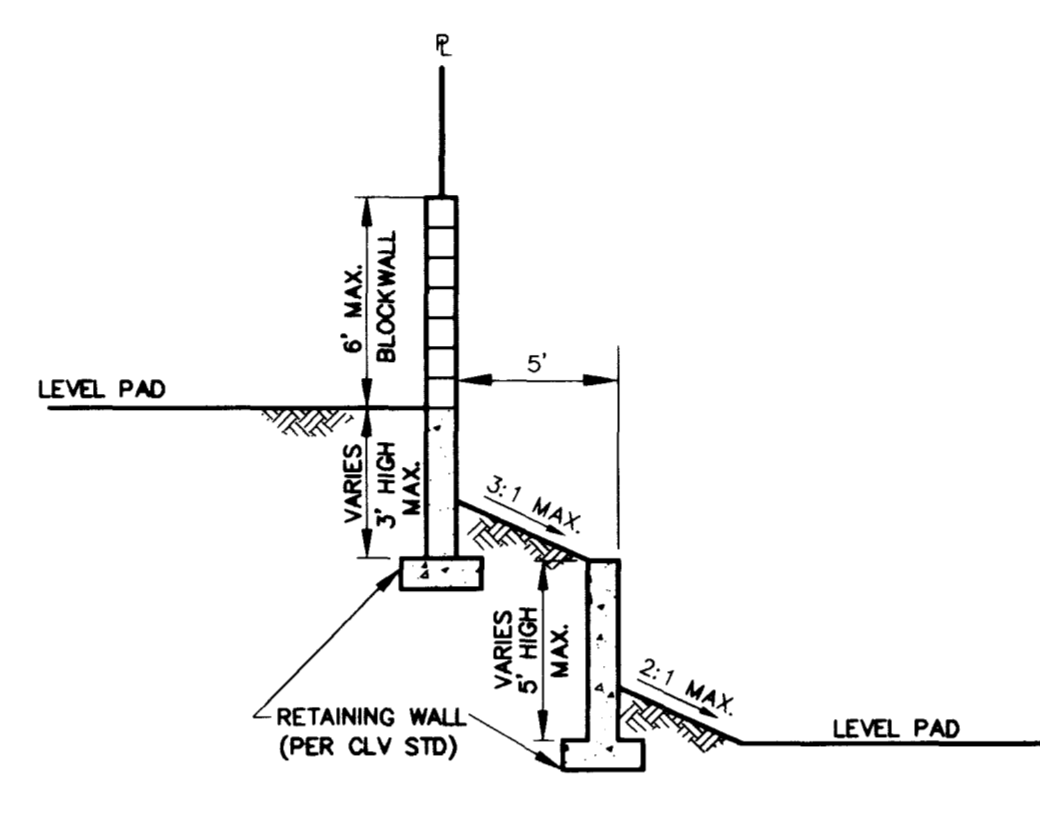

9 REAR YARD PERIMETER DETAIL

SCALE: NO SCALE

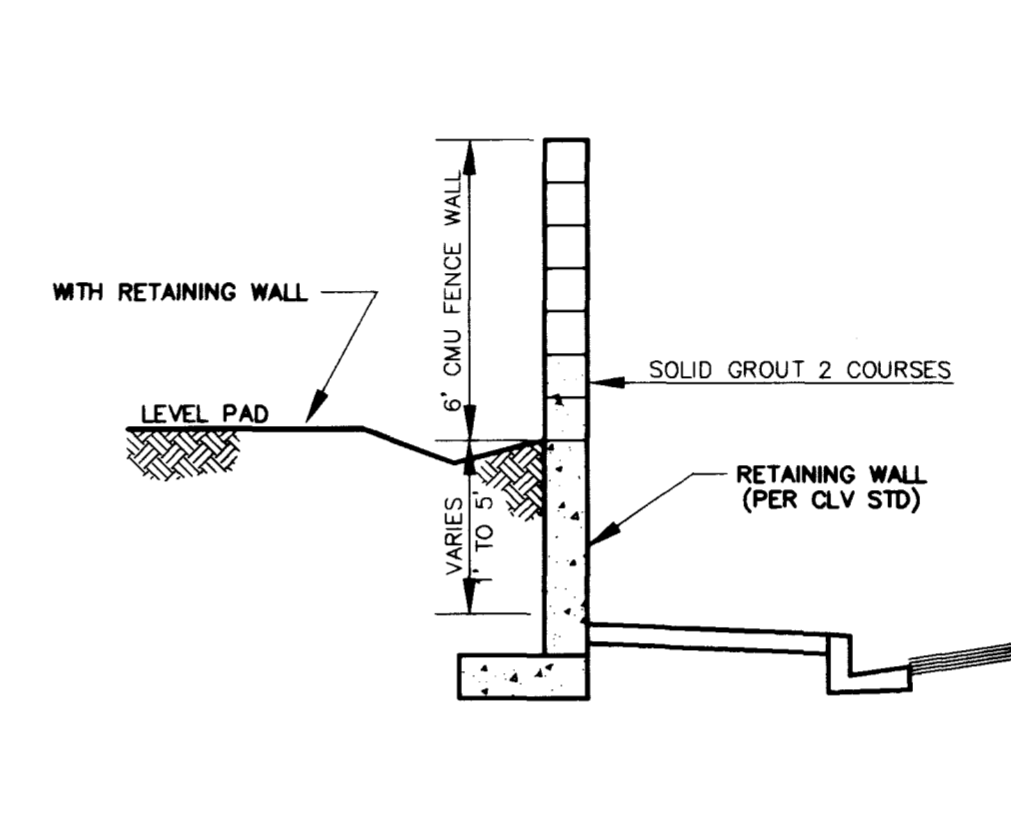

5 SIDE YARD WITH RETAINING DETAIL

SCALE: NO SCALE

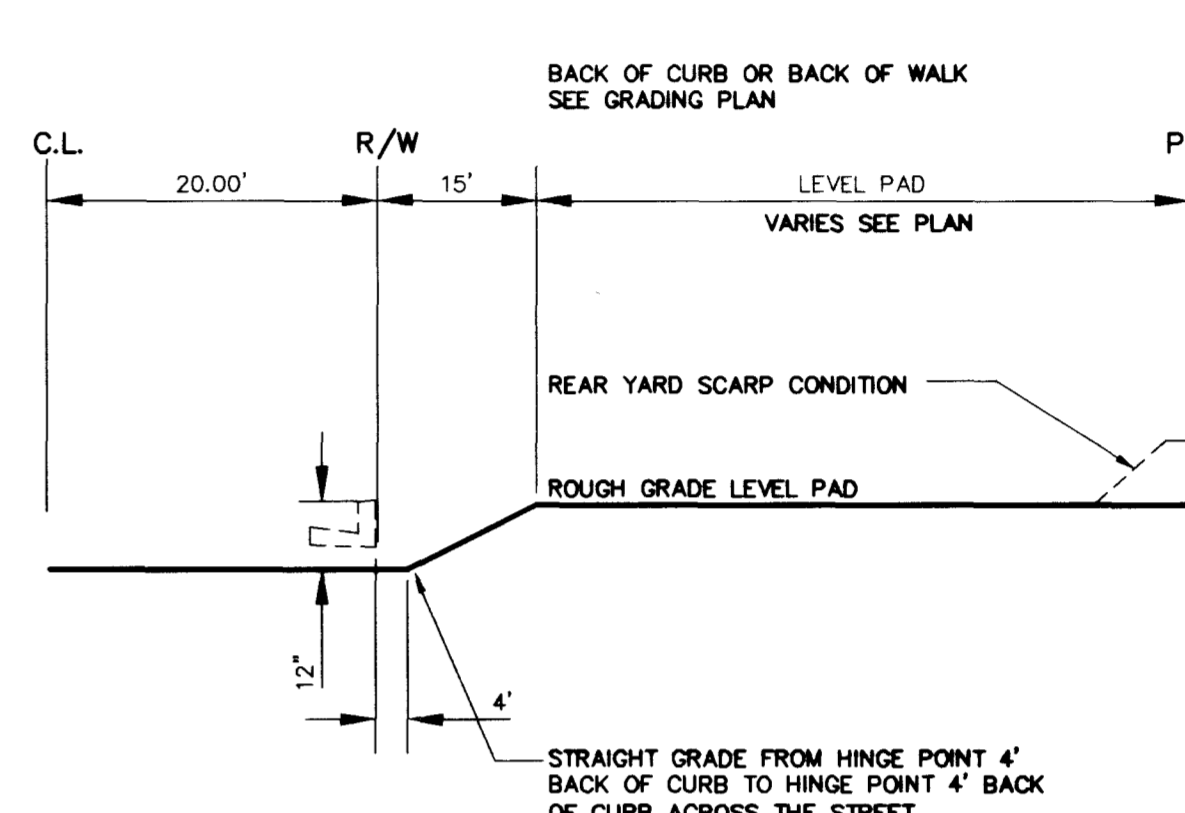

1 PAD GRADING SECTION

SCALE: NO SCALE

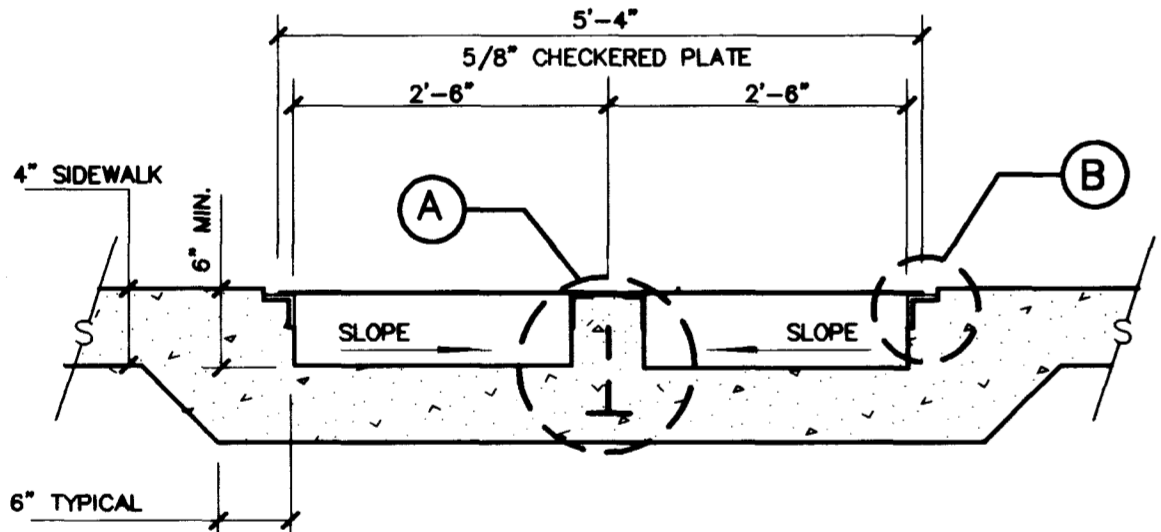

FOR ADDITIONAL DESIGN REQUIREMENTS SEE USD #236

16 SIDEWALK UNDERDRAIN DETAIL

SCALE: NO SCALE

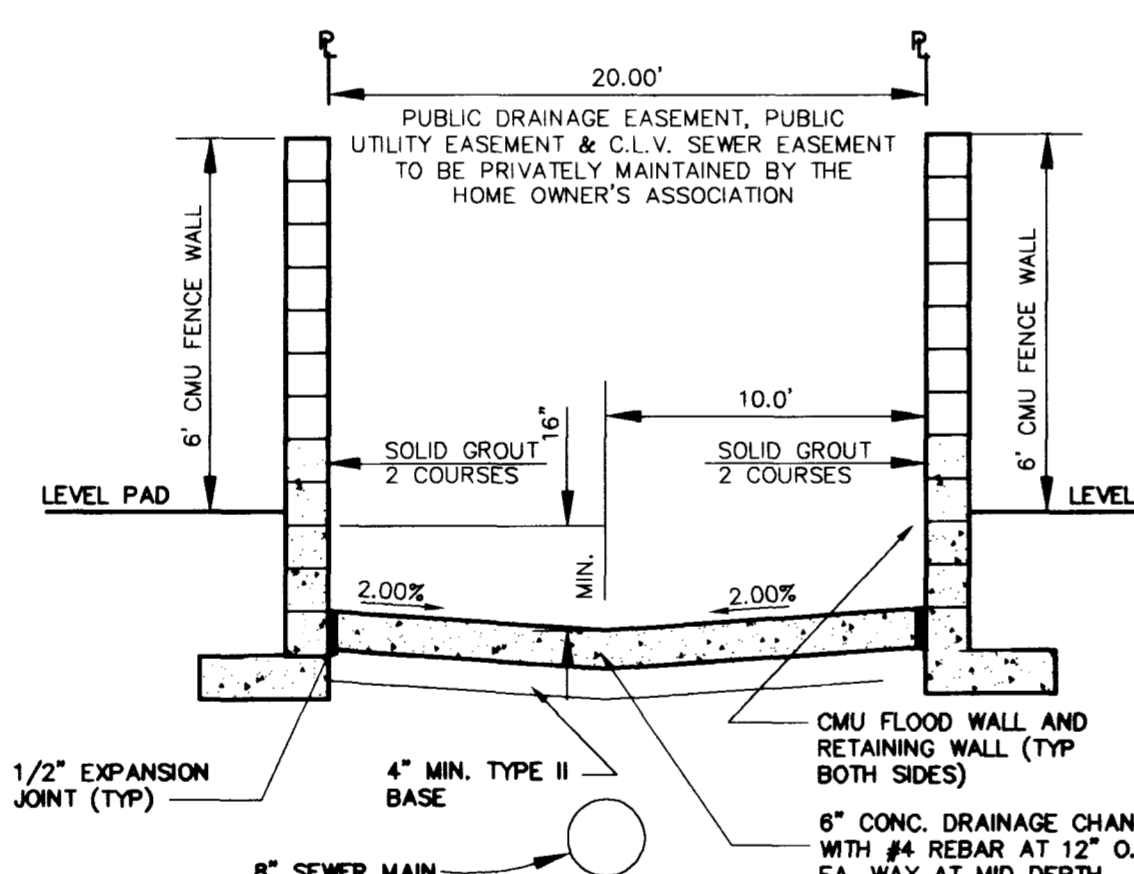

14 CONCRETE CHANNEL DETAIL

SCALE: NO SCALE

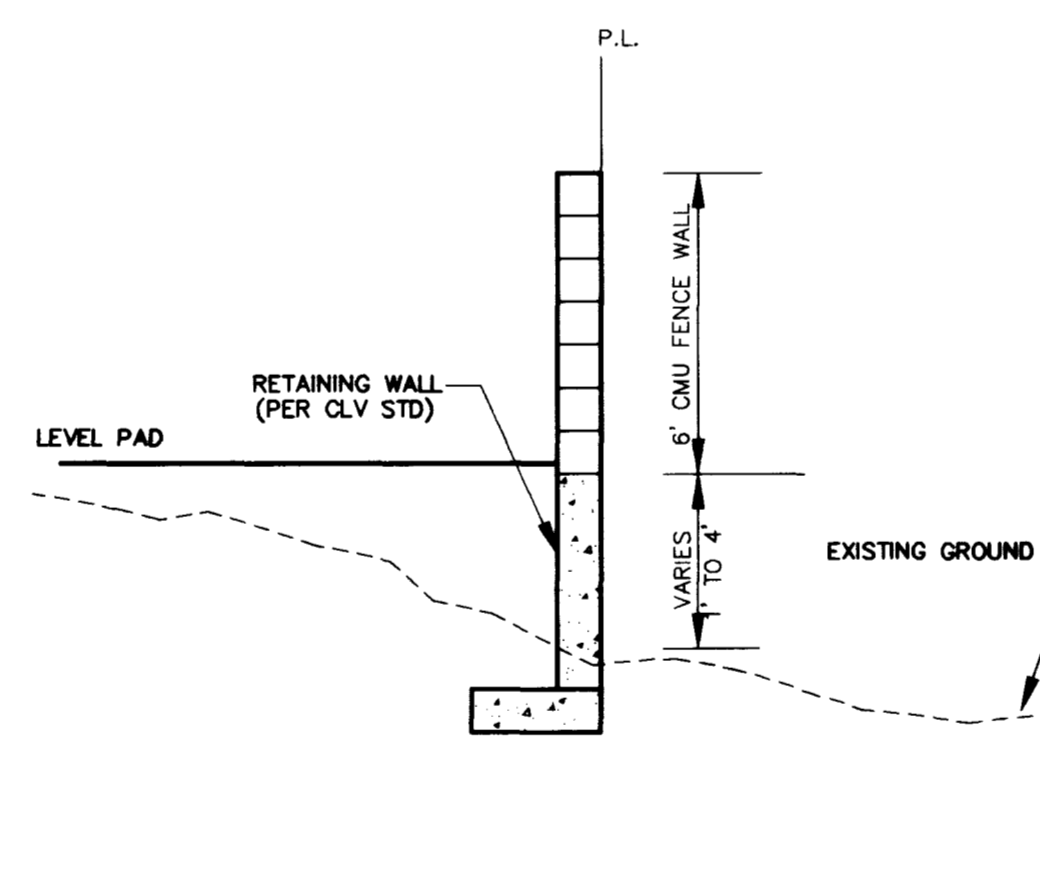

10 REAR YARD PERIMETER DETAIL

SCALE: NO SCALE

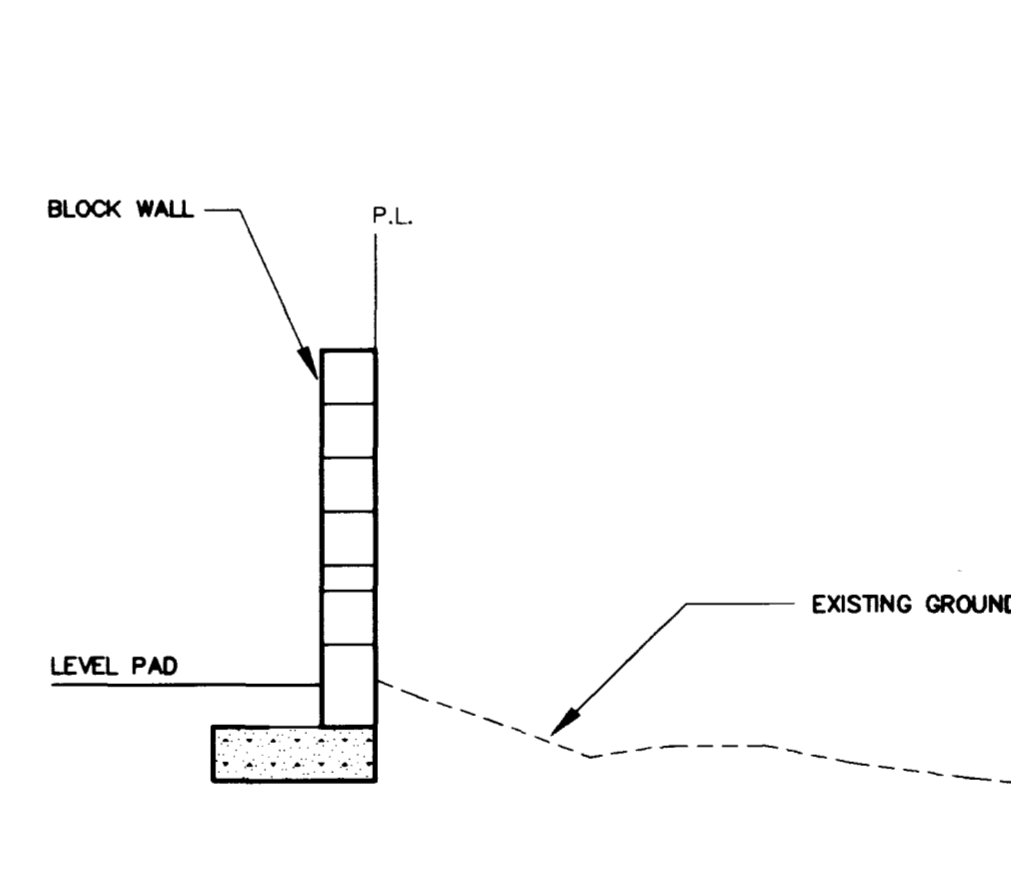

6 REAR YARD PERIMETER DETAIL

SCALE: NO SCALE

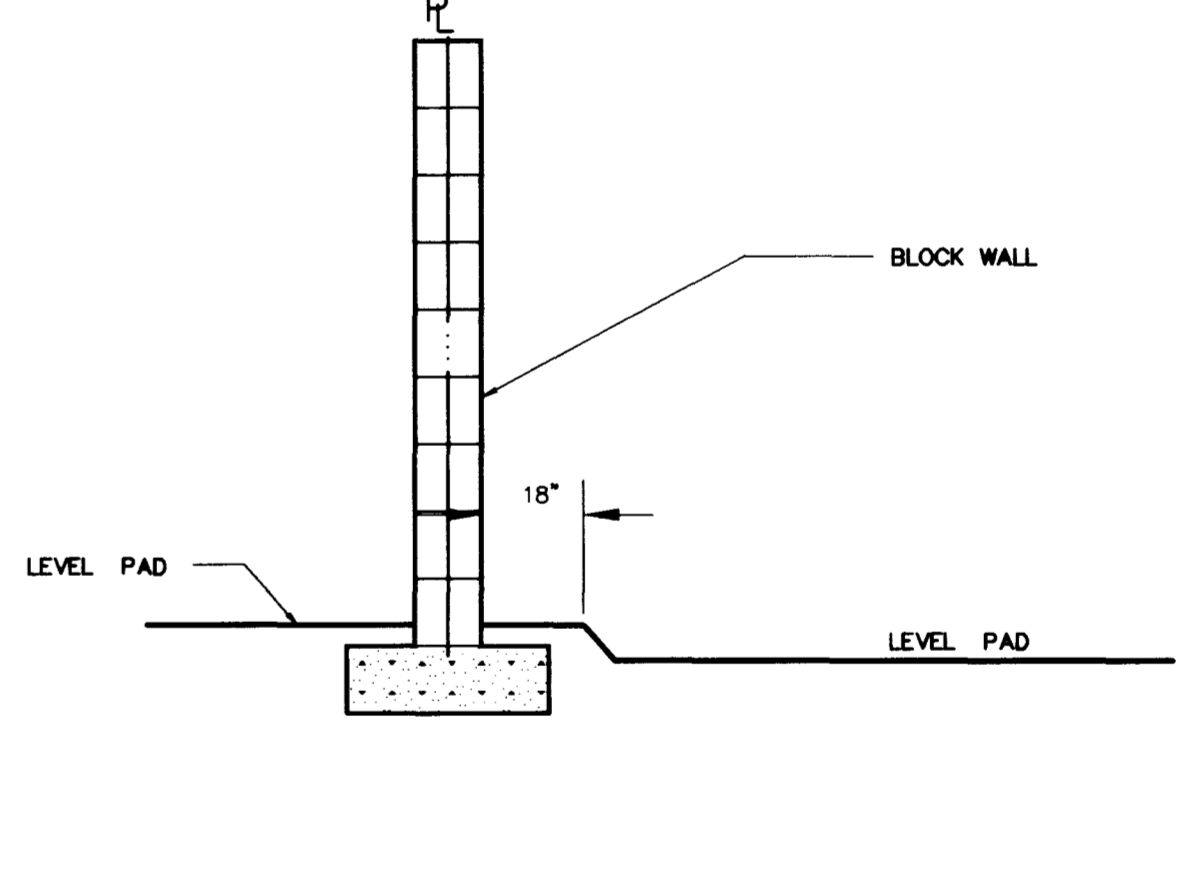

2 TYPICAL SIDE YARD DETAIL

SCALE: NO SCALE

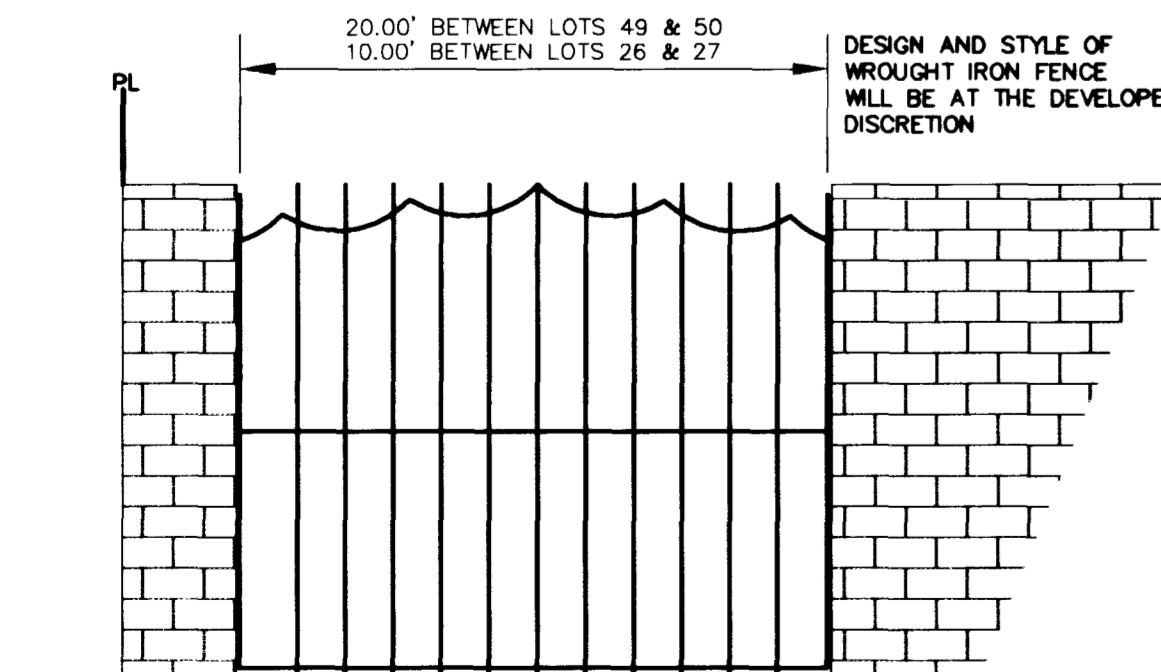

17 WROUGHT IRON FENCE

SCALE: NO SCALE

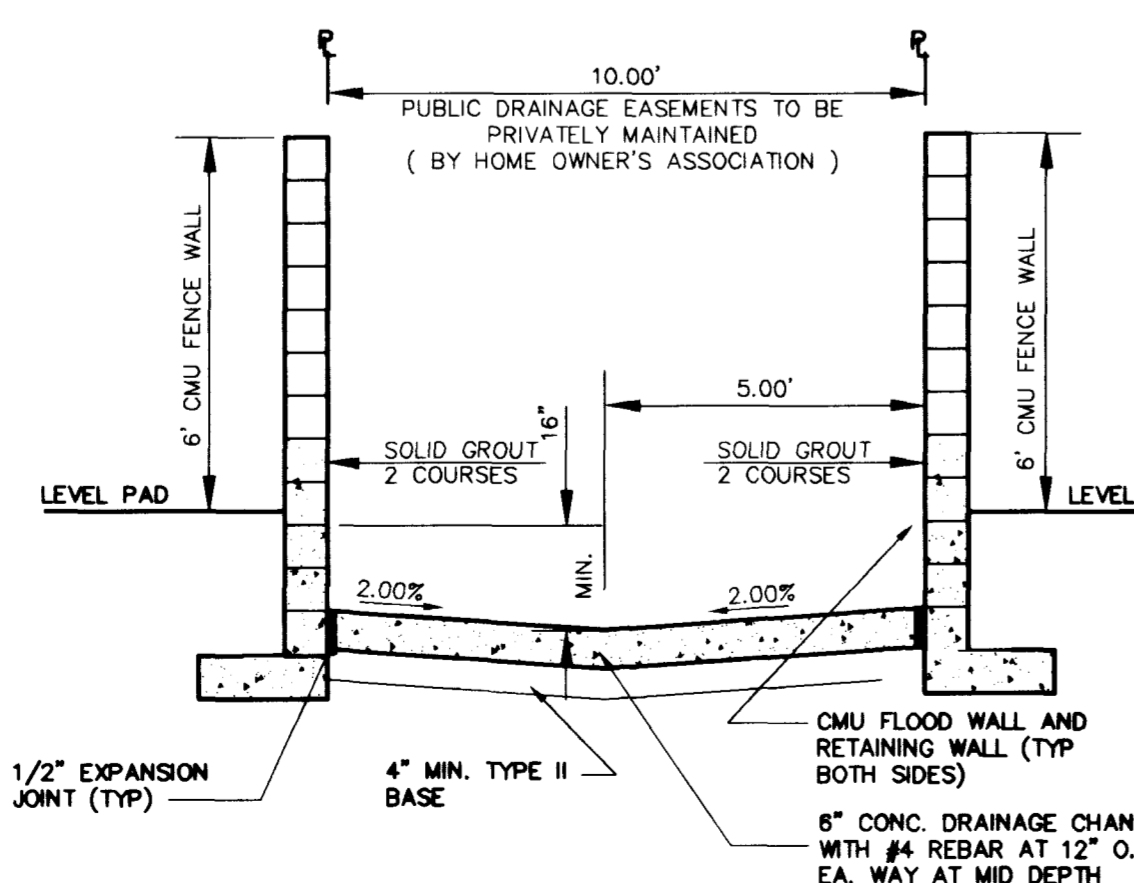

15 CONCRETE CHANNEL DETAIL

SCALE: NO SCALE

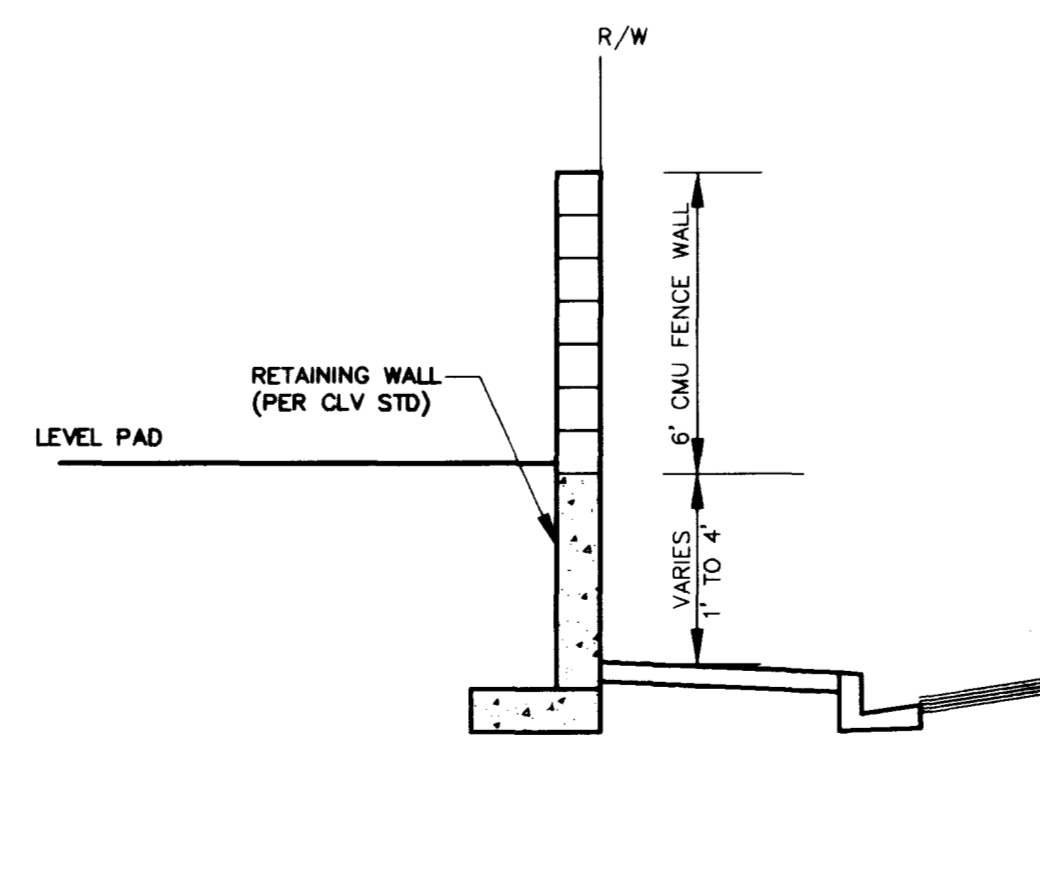

11 REAR YARD PERIMETER DETAIL

SCALE: NO SCALE

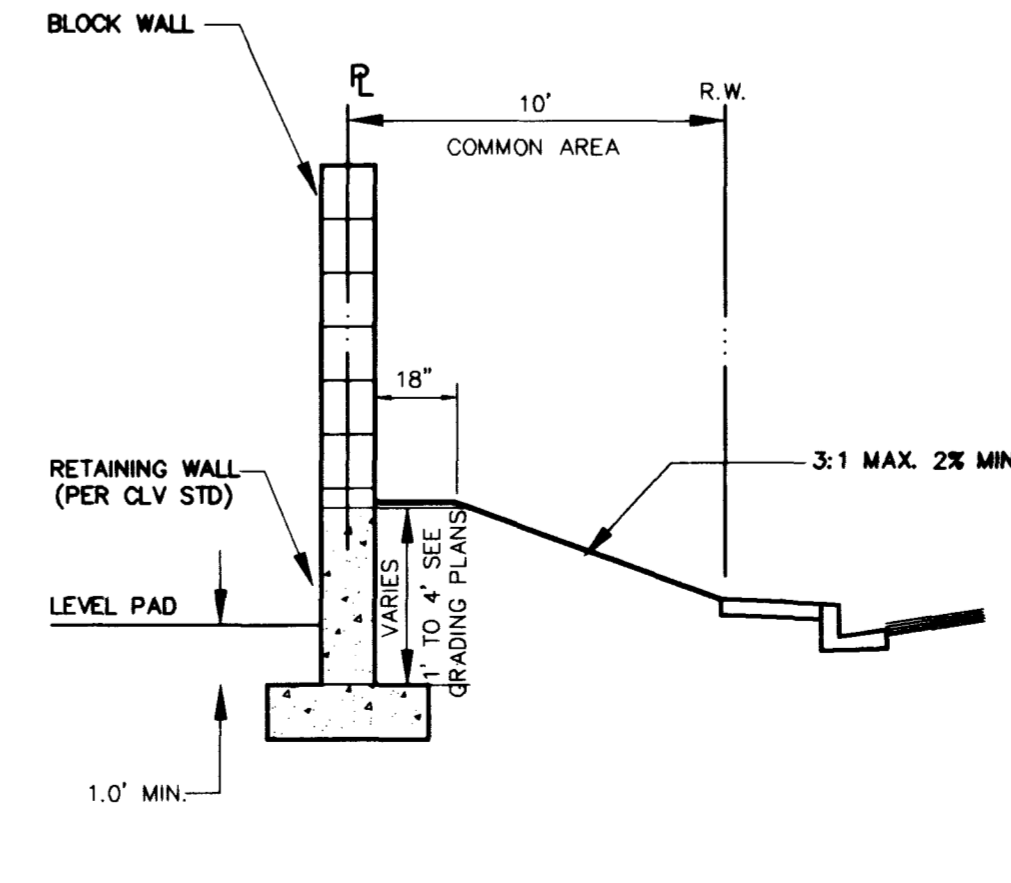

7 REAR YARD PERIMETER DETAIL / WITH RETAINING

SCALE: NO SCALE

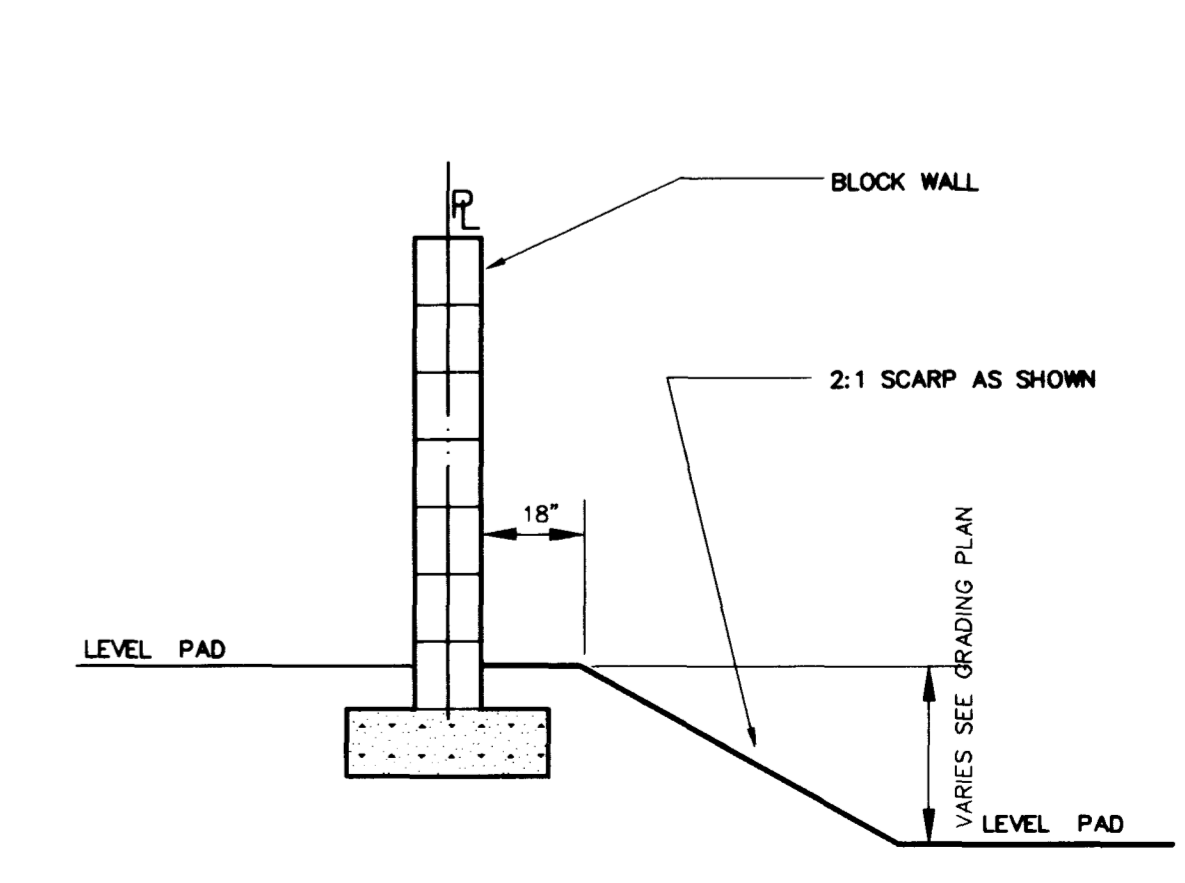

3 REAR YARD DETAIL

SCALE: NO SCALE

NO.	DESCRIPTION	DATE	APP'D.

RECOMMENDED BY: **LENNARE GROSZINSKI CIVIL**
 P. E. # 0169 0100
 NO. 8000

DATE: 08/05/98	DESIGNED BY: FC	CHECKED BY: P. E. # 0169 0100	SCALE: NONE
----------------	-----------------	-------------------------------	-------------

PENTACORE
 CIVIL ENGINEERING • LAND SURVEYING • PLANNING
 CONSTRUCTION MANAGEMENT • PCA CONSULTING
 LAS VEGAS, NEVADA 89102 (702)258-0115

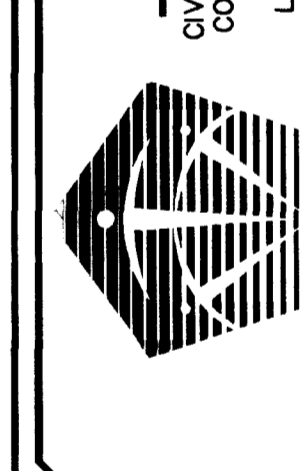

FALCON HOMES
 CHEYENNE RIDGE PHASE 2
 GRADING DETAILS

4646

11-13-120

1074-4323-2-1



4 SEE THIS PERIMETER DETAIL
WHEN IN PLACE

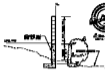

12 SEE THIS PERIMETER DETAIL
WHEN IN PLACE



8 SEE THIS PERIMETER DETAIL
WHEN IN PLACE



4 SEE THIS NEW RETAINING DETAIL
WHEN IN PLACE



7 TYPICAL LOT DRAINAGE - TYPE "A"
WHEN IN PLACE

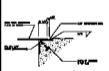

5 SEE THIS NEW RETAINING DETAIL
WHEN IN PLACE



13 SEE THIS PERIMETER DETAIL
WHEN IN PLACE



9 SEE THIS PERIMETER DETAIL
WHEN IN PLACE



6 SEE THIS NEW RETAINING DETAIL
WHEN IN PLACE



1 NO SHOW BENCH
WHEN IN PLACE

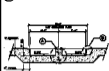

10 REVERSE SLOTTED DRAINAGE DETAIL
WHEN IN PLACE



14 CROWNED CHANNEL DETAIL
WHEN IN PLACE



11 SEE THIS PERIMETER DETAIL
WHEN IN PLACE



8 SEE THIS PERIMETER DETAIL
WHEN IN PLACE



2 TYPICAL NEW YARD DETAIL
WHEN IN PLACE



17 CROWNED NEW FENCE
WHEN IN PLACE



13 CROWNED CHANNEL DETAIL
WHEN IN PLACE



11 SEE THIS PERIMETER DETAIL
WHEN IN PLACE



7 SEE THIS PERIMETER DETAIL / NEW RETAINING
WHEN IN PLACE



3 SEE THIS DETAIL
WHEN IN PLACE



PENTACORE
CONCRETE PRODUCTS

FLUSH FENCES
CROWNED NEW FENCE 1
CROWNED DETAIL