

2452

Apr. 25, 2010 - 8:04am - USER peter.meyerhofer  
\\LAMP01\Projects\AV\_Public\Trns\092225\019\_Bonneville-Clark\_2008\CADD\256019gd-03\_08.dwg

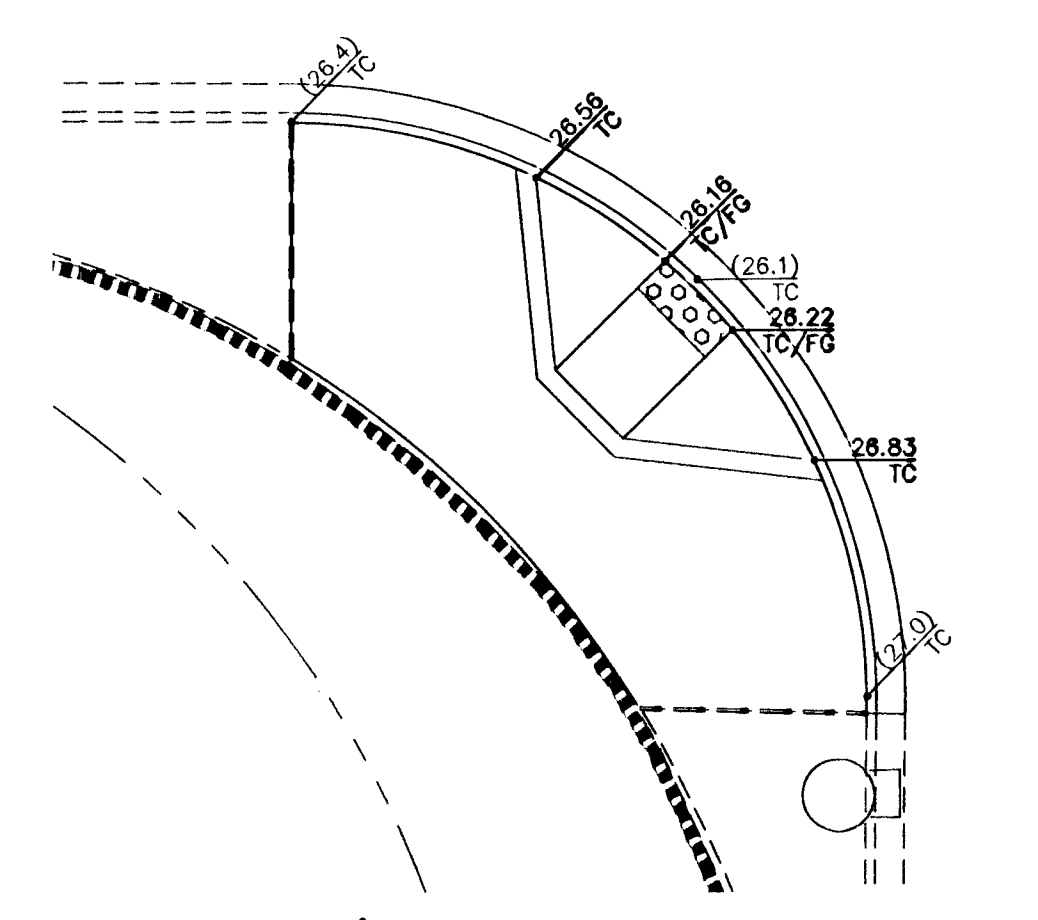

BONNEVILLE/MAIN INTERSECTION GRADING  
1"=10'

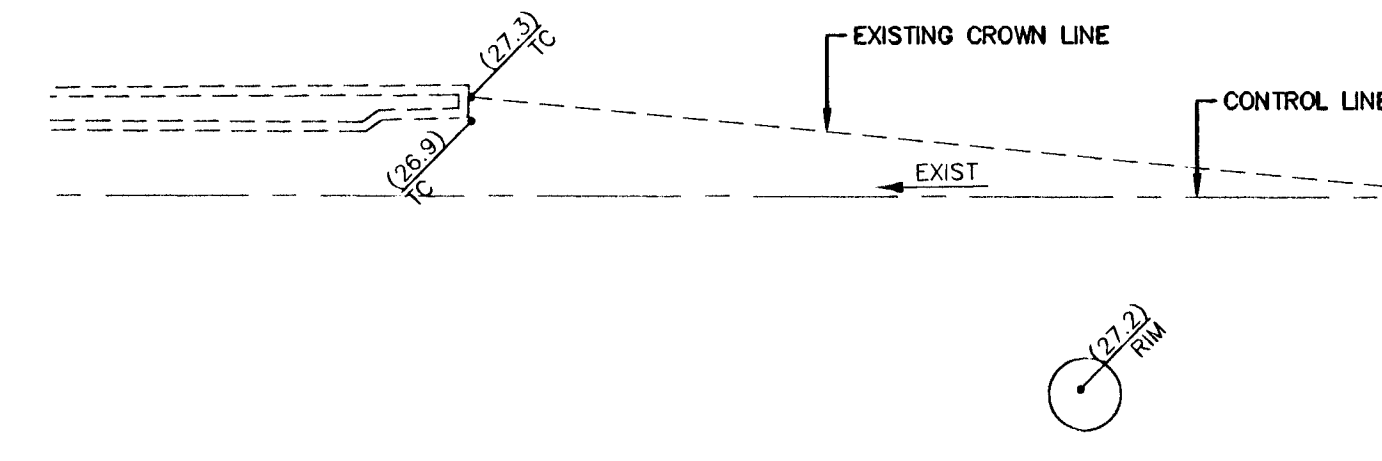
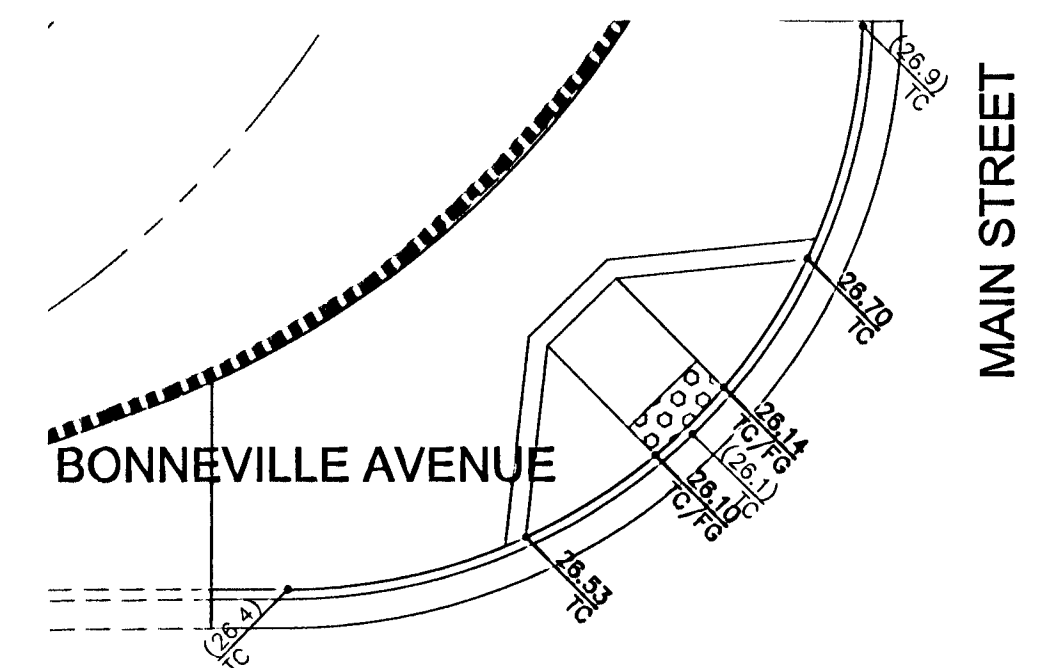
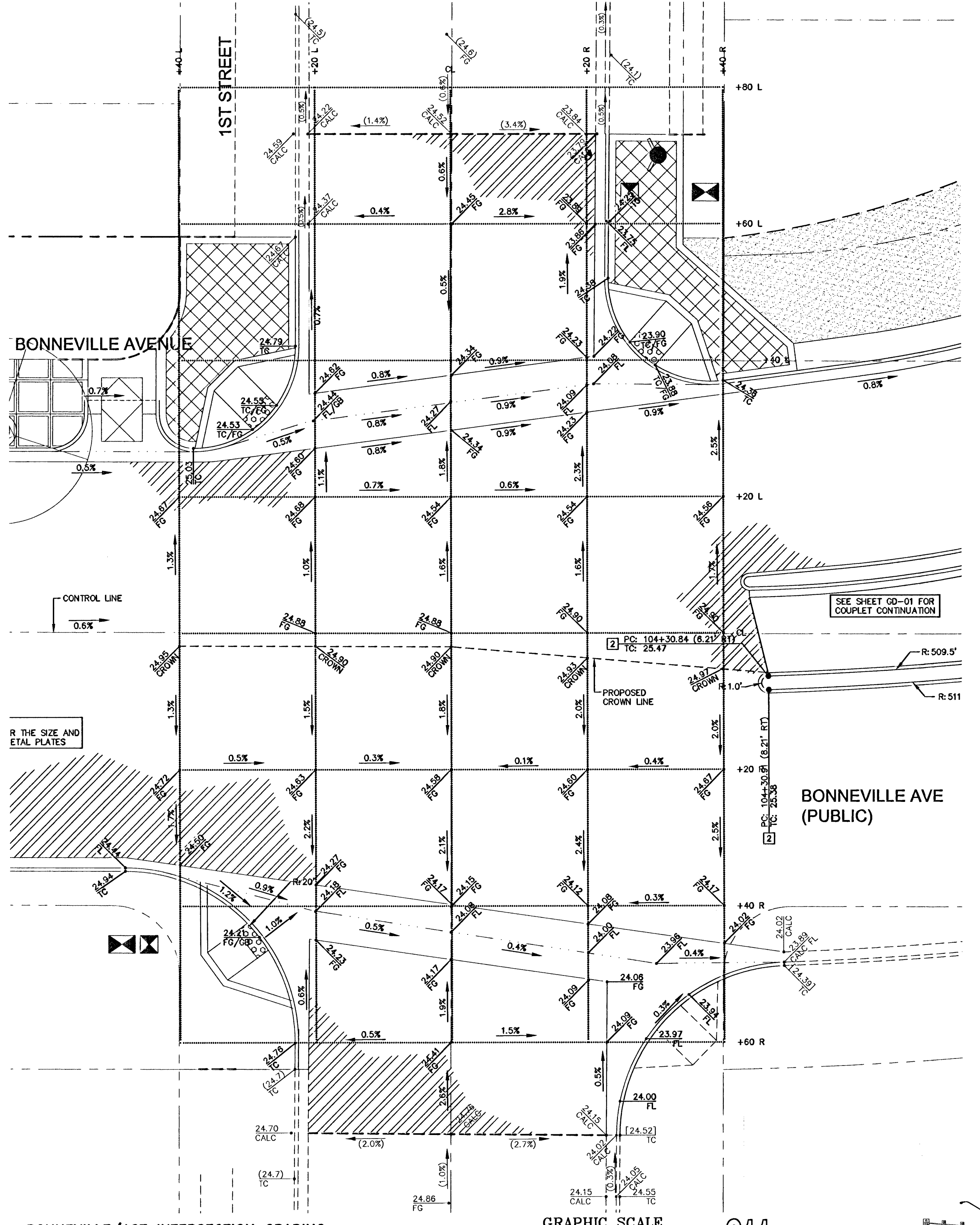
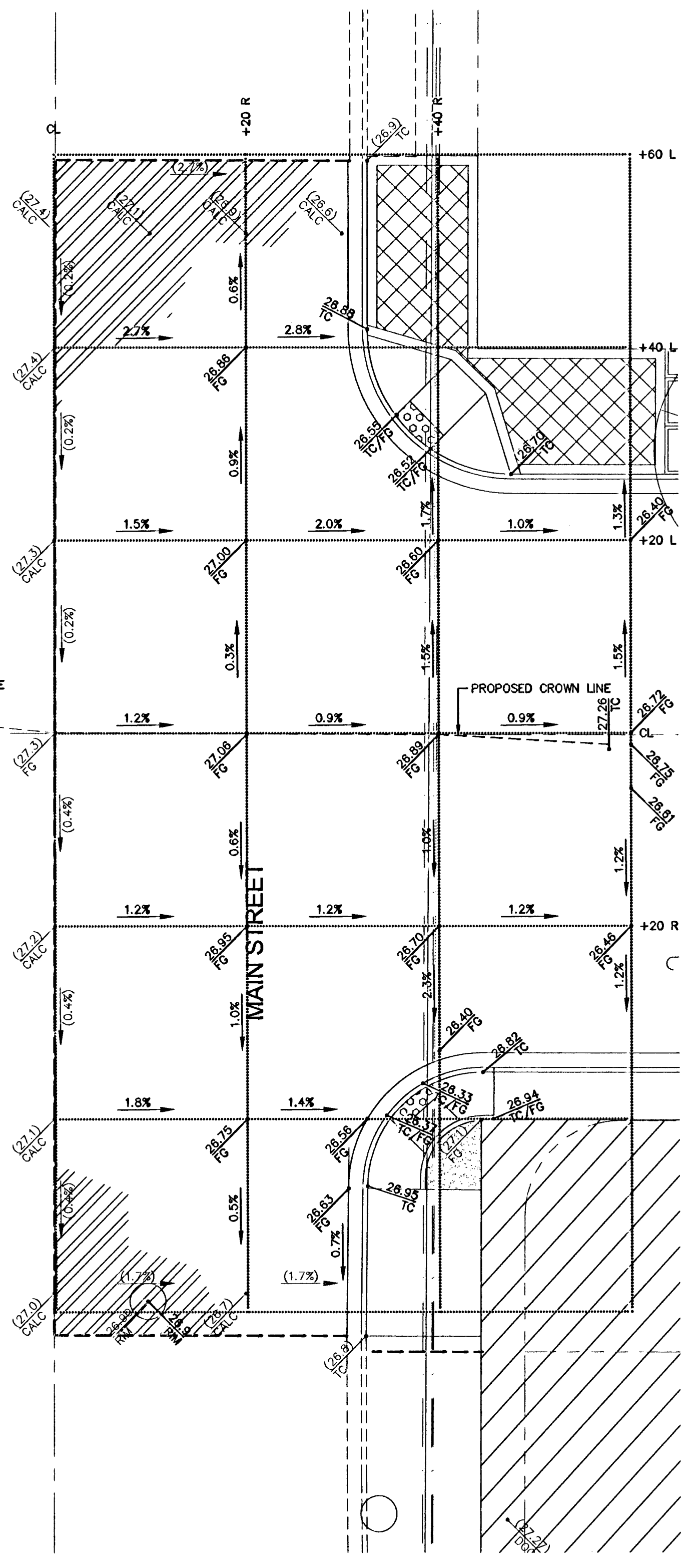

BONNEVILLE/1ST INTERSECTION GRADING  
1"=10'

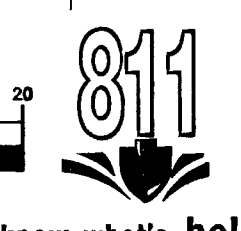
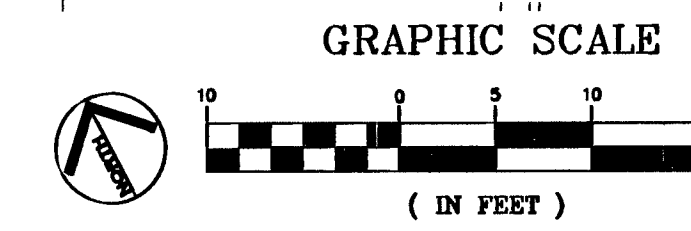

**SAFETY ALERT**  
Call before you dig  
Before you dig  
Underground  
1-702-227-2829



DATE	REVISIONS
DATE: FEBRUARY 2010	CHECKED BY: PM/JCC
SCALE (H): 1"=10'	DESIGNED BY: TEA
SCALE (V): N/A	DESIGNED BY: TEA
DRAWN BY: TEA	
 <b>Kimley-Horn and Associates, Inc.</b> Engineering, Planning, and Environmental Consultants 2050 E. Flamingo Road, Suite 210, Las Vegas, NV 89119 PH: (702) 738-4949 FAX: (702) 738-5666	
 <b>PETER N. MEYERHOFER</b> CIVIL ENGINEER Exp. 12/31/11	
<b>DEPARTMENT OF PUBLIC WORKS</b> PROJECT: <b>BONNEVILLE/CLARK ONEWAY COUPLLET PHASE 1 IMPROVEMENT PLANS</b> SHEET: <b>GRADING DETAIL INTERSECTION GRADING SHEET</b> SHEET NO. GD-05 SHEET 31 OF 91 DRAWING NO. 107V5201	
BID# 09.1730.37	